

**AERONAUTICAL INFORMATION  
PUBLICATION**

**COOK ISLANDS**



## GEN 0.1 PREFACE

### 1 PROVISION OF THE AIP — COOK ISLANDS

#### 1.1 General

1.1.1 Provision of the AIP — Cook Islands is the responsibility of the Cook Islands Airport Authority under delegation from the Ministry of Transport, Cook Islands. It is published by Aeropath, an AIS provider contracted by CAA of New Zealand, under Rule Part 175 to provide the AIP service containing information relevant to operations within the Cook Sector and the Rarotonga CTR/CTA of the Auckland Oceanic FIR. For operations within the Auckland Oceanic FIR, operators should refer to the AIP New Zealand.

### 2 PUBLISHING AUTHORITY

#### 2.1 Authority

Secretary for Transport  
Ministry of Transport  
PO Box 61  
Rarotonga  
COOK ISLANDS

TEL (682) 28 810  
FAX (682) 28 816  
Email [transport@cookislands.gov.ck](mailto:transport@cookislands.gov.ck)  
Website [www.transport.gov.ck](http://www.transport.gov.ck)

AFTN NCRGYAYX

## 2.2 Publisher

Aeropath  
PO Box 294  
Wellington 6140  
NEW ZEALAND

TEL (64) 4 471 1899  
FAX Nil

TELEX Nil  
AFTN Nil

email [aim@aeropath.aero](mailto:aim@aeropath.aero)  
website [www.nzais.co.nz](http://www.nzais.co.nz)

## 3 APPLICABLE ICAO DOCUMENTS

### 3.1 General

3.1.1 The Cook Islands Aeronautical Information Publication has been prepared in accordance with the Standards and Recommended Practices of ICAO Annex 15 and the guidance material in the ICAO Annex 15 Aeronautical Information Services and guidance material in ICAO DOC 8126 Aeronautical Information Services Manual.

3.1.2 The following ICAO documents are applicable to operations within the Cook Sector of the Auckland Oceanic FIR:

- (a) Annex 2 — *Rules of the Air*
- (b) Annex 3 — *Meteorology*
- (c) Annex 4 — *Aeronautical Charts*
- (d) Annex 5 — *Units of Measurement to be Used in Air and Ground Operations*
- (e) Annex 6 — *Operation of Aircraft*
- (f) Annex 7 — *Aircraft Nationality and Registration Marks*
- (g) Annex 8 — *Airworthiness of Aircraft*
- (h) Annex 9 — *Facilitation*
- (i) Annex 10 — *Aeronautical Telecommunications*
- (j) Annex 11 — *Air Traffic Services*
- (k) Annex 12 — *Search and Rescue*
- (l) Annex 13 — *Aircraft Accident and Incident Investigation*

- (m) Annex 14 — *Aerodromes*
- (n) Annex 15 — *Aeronautical Information Services*
- (o) Annex 16 — *Environmental Protection*
- (p) Annex 17 — *Security, Safeguarding International Civil Aviation against Acts of Unlawful Interference*
- (q) Annex 18 — *Safe Transport of Dangerous Goods by Air*
- (r) Doc 8126 — *AIS Manual*
- (s) Doc 8168 — *Procedures for Air Navigations Services — Rules of the Air and Air Traffic Services (PANS – RAC)*
- (t) Doc 8400 — *ICAO Abbreviations and Codes*
- (u) Doc 8585 — *Designators for Aircraft Operating Agencies, Aeronautical Authorities and Services*
- (v) Doc 8643 — *Aircraft Type Designators*
- (w) Doc 8697 — *Aero Chart Manual*
- (x) Doc 9432 — *Manual of Radio Telephony*
- (y) Doc 7910 — *ICAO Location Indicators*
- (z) Doc 9137 — *ICAO Airport Services Manual*

## 4 AIP STRUCTURE AND AMENDMENT INTERVAL

### 4.1 General

4.1.1 The AIP — Cook Islands includes this manual and the AIP Supplement — Cook Islands.

4.1.2 Amendments to the AIP — Cook Islands are issued at regular intervals in accordance with the ICAO AIRAC schedule. The amendment cycle for the AIP — Cook Islands is shown in [Table GEN 0.1 - 1](#).

**Table GEN 0.1 - 1  
Amendment Schedule**

AIP AMENDMENT NUMBER	EFFECTIVE DATE

#### **Note**

AIP and chart amendments are scheduled only for the amendment numbers shown. AIP Supplements may be issued at any of the available effective dates.

## **4.2 Amendments**

4.2.1 Amendments to the AIP — Cook Islands are issued as replacement pages, or in the case of Enroute Charts, as replacement charts.

## **4.3 Amendment Bulletin**

4.3.1 A Bulletin will be issued with each amendment to the AIP — Cook Islands providing a summary of significant changes.

## **4.4 Annotation of Amendments**

4.4.1 Changes to text or new information in the AIP — Cook Islands are identified by a vertical black line (revision bar) in the margin. Deletions are identified by a “D”. Changes in the Checklist of AIP Pages are identified by a grey shading. Changes to charts are indicated by a note in the right margin of the charts, giving the previous effective date and changes from the previous edition.

## **4.5 Nil Amendment Notification**

4.5.1 In the event of there being no changes effective at a scheduled effective date, a “NIL Amendment” notification will be issued by NOTAM.

# **5 NOTIFICATION OF ERRORS AND OMISSIONS**

## **5.1 General**

5.1.1 Errors, omissions and suggestions for improvement of the AIP — Cook Islands, AIP Supplement — Cook Islands, and Enroute Charts should be notified immediately to:

Secretary for Transport  
Ministry of Transport  
PO Box 61  
Rarotonga  
COOK ISLANDS

TEL (682) 28 810

FAX (682) 28 816

AFTN NCRGYAYX

# **Intentionally Blank**



## GEN 0.2 RECORD OF AIP AMENDMENTS

### 1 AIP AMENDMENT DATES

#### 1.1 General

1.1.1 Table GEN 0.2 - 1 lists AIP Amendments to the AIP — Cook Islands.

**Table GEN 0.2 - 1**  
**Record of Amendments**

AMENDMENT NUMBER	EFFECTIVE DATE	DATE INSERTED	INSERTED BY
1	2 APR 15		INCORPORATED
2	30 APR 15		INCORPORATED
3	23 JUL 15		INCORPORATED
4	17 SEP 15		INCORPORATED
5	12 NOV 15		INCORPORATED
6	31 MAR 16		INCORPORATED
7	15 SEP 16		INCORPORATED
8	25 MAY 17		INCORPORATED
9	19 JUL 18		INCORPORATED
10	13 SEP 18		INCORPORATED
11	8 NOV 18		INCORPORATED
12	6 DEC 18		INCORPORATED

# **Intentionally Blank**

## GEN 0.3 RECORD OF AIP SUPPLEMENTS

### 1 AIP SUPPLEMENTS

#### 1.1 General

1.1.1 AIP Supplement — Cook Islands are issued separately. Each issue includes a current checklist.

**Table GEN 0.3 - 1  
Record of Supplements**

SUPPLEMENT NUMBER	EFFECTIVE DATE

# **Intentionally Blank**

**GEN 0.4 CHECKLIST OF AIP PAGES**

<b>Page No</b>	<b>Effective</b>	<b>Page No</b>	<b>Effective</b>
<b>GENERAL</b>		GEN 1.2-1	13 SEP 18
GEN 0.1-1	13 SEP 18	GEN 1.2-2	13 SEP 18
GEN 0.1-2	13 SEP 18	GEN 1.2-3	13 SEP 18
GEN 0.1-3	13 SEP 18	GEN 1.2-4	13 SEP 18
GEN 0.1-4	15 DEC 11	GEN 1.2-5	13 SEP 18
GEN 0.1-5	15 DEC 11	GEN 1.2-6	13 SEP 18
GEN 0.1-6	15 DEC 11	GEN 1.2-7	13 SEP 18
GEN 0.2-1	15 DEC 11	GEN 1.2-8	13 SEP 18
GEN 0.2-2	15 DEC 11	GEN 1.3-1	13 SEP 18
GEN 0.3-1	15 DEC 11	GEN 1.3-2	13 SEP 18
GEN 0.3-2	15 DEC 11	GEN 1.3-3	13 SEP 18
GEN 0.4-1	6 DEC 18	GEN 1.3-4	13 SEP 18
GEN 0.4-2	6 DEC 18	GEN 1.4-1	15 DEC 11
GEN 0.4-3	6 DEC 18	GEN 1.4-2	15 DEC 11
GEN 0.4-4	6 DEC 18	GEN 1.5-1	15 DEC 11
GEN 0.4-5	6 DEC 18	GEN 1.5-2	15 DEC 11
GEN 0.4-6	6 DEC 18	GEN 1.6-1	13 SEP 18
GEN 0.4-7	6 DEC 18	GEN 1.6-2	15 DEC 11
GEN 0.4-8	6 DEC 18	GEN 1.7-1	15 DEC 11
GEN 0.6-1	13 SEP 18	GEN 1.7-2	15 DEC 11
GEN 0.6-2	13 SEP 18	GEN 2-1	15 DEC 11
GEN 0.6-3	13 SEP 18	GEN 2-2	15 DEC 11
GEN 0.6-4	13 SEP 18	GEN 2.1-1	15 DEC 11
GEN 0.6-5	13 SEP 18	GEN 2.1-2	15 DEC 11
GEN 0.6-6	8 NOV 18	GEN 2.1-3	13 SEP 18
GEN 0.6-7	8 NOV 18	GEN 2.1-4	2 APR 15
GEN 0.6-8	13 SEP 18	GEN 2.2-1	15 DEC 11
GEN 0.6-9	13 SEP 18	GEN 2.2-2	15 DEC 11
GEN 0.6-10	13 SEP 18	GEN 2.2-3	15 DEC 11
GEN 1-1	15 DEC 11	GEN 2.2-4	15 DEC 11
GEN 1-2	15 DEC 11	GEN 2.2-5	15 DEC 11
GEN 1.1-1	13 SEP 18	GEN 2.2-6	15 DEC 11
GEN 1.1-2	13 SEP 18	GEN 2.2-7	15 DEC 11
GEN 1.1-3	13 SEP 18	GEN 2.2-8	15 DEC 11
GEN 1.1-4	13 SEP 18	GEN 2.2-9	15 DEC 11
GEN 1.1-5	13 SEP 18	GEN 2.2-10	15 DEC 11
GEN 1.1-6	13 SEP 18		

<b>Page No</b>	<b>Effective</b>	<b>Page No</b>	<b>Effective</b>
GEN 2.2-11	15 DEC 11	GEN 3.1-3	8 NOV 18
GEN 2.2-12	15 DEC 11	GEN 3.1-4	8 NOV 18
GEN 2.2-13	2 APR 15	GEN 3.1-5	8 NOV 18
GEN 2.2-14	15 DEC 11	GEN 3.1-6	8 NOV 18
GEN 2.2-15	15 DEC 11	GEN 3.2-1	8 NOV 18
GEN 2.2-16	15 DEC 11	GEN 3.2-2	15 DEC 11
GEN 2.2-17	15 DEC 11	GEN 3.3-1	8 NOV 18
GEN 2.2-18	15 DEC 11	GEN 3.3-2	8 NOV 18
GEN 2.2-19	15 DEC 11	GEN 3.3-3	8 NOV 18
GEN 2.2-20	15 DEC 11	GEN 3.3-4	8 NOV 18
GEN 2.2-21	15 DEC 11	GEN 3.3-5	8 NOV 18
GEN 2.2-22	15 DEC 11	GEN 3.3-6	8 NOV 18
GEN 2.2-23	15 DEC 11	GEN 3.4-1	15 DEC 11
GEN 2.2-24	15 DEC 11	GEN 3.4-2	15 DEC 11
GEN 2.2-25	31 MAR 16	GEN 3.4-3	8 NOV 18
GEN 2.2-26	15 DEC 11	GEN 3.4-4	8 NOV 18
GEN 2.2-27	15 DEC 11	GEN 3.4-5	15 DEC 11
GEN 2.2-28	15 DEC 11	GEN 3.4-6	15 DEC 11
GEN 2.3-1	15 DEC 11	GEN 3.5-1	8 NOV 18
GEN 2.3-2	15 DEC 11	GEN 3.5-2	15 DEC 11
GEN 2.3-3	15 DEC 11	GEN 3.5-3	15 DEC 11
GEN 2.3-4	15 DEC 11	GEN 3.5-4	15 DEC 11
GEN 2.3-5	15 DEC 11	GEN 3.5-5	15 DEC 11
GEN 2.3-6	15 DEC 11	GEN 3.5-6	15 DEC 11
GEN 2.3-7	15 DEC 11	GEN 3.5-7	15 DEC 11
GEN 2.3-8	15 DEC 11	GEN 3.5-8	15 DEC 11
GEN 2.3-9	15 DEC 11	GEN 3.6-1	15 DEC 11
GEN 2.3-10	15 DEC 11	GEN 3.6-2	15 DEC 11
GEN 2.4-1	15 DEC 11	GEN 3.6-3	15 DEC 11
GEN 2.4-2	15 DEC 11	GEN 3.6-4	15 DEC 11
GEN 2.5-1	2 APR 15	GEN 3.6-5	15 DEC 11
GEN 2.5-2	2 APR 15	GEN 3.6-6	15 DEC 11
GEN 2.6-1	15 DEC 11	GEN 3.6-7	15 DEC 11
GEN 2.6-2	15 DEC 11	GEN 3.6-8	15 DEC 11
GEN 2.7-1	15 DEC 11	GEN 3.6-9	15 DEC 11
GEN 2.7-2	15 DEC 11	GEN 3.6-10	15 DEC 11
GEN 3-1	15 DEC 11	GEN 3.6-11	15 DEC 11
GEN 3-2	15 DEC 11	GEN 3.6-12	15 DEC 11
GEN 3.1-1	8 NOV 18	GEN 3.6-13	15 DEC 11
GEN 3.1-2	8 NOV 18	GEN 3.6-14	15 DEC 11

<b>Page No</b>	<b>Effective</b>	<b>Page No</b>	<b>Effective</b>
GEN 3.6-15	15 DEC 11	ENR 1.2-7	15 DEC 11
GEN 3.6-16	15 DEC 11	ENR 1.2-8	15 DEC 11
GEN 4-1	15 DEC 11	ENR 1.3-1	15 DEC 11
GEN 4-2	15 DEC 11	ENR 1.3-2	15 DEC 11
GEN 4.1-1	13 SEP 18	ENR 1.3-3	15 DEC 11
GEN 4.1-2	13 SEP 18	ENR 1.3-4	15 DEC 11
GEN 4.1-3	15 DEC 11	ENR 1.3-5	15 DEC 11
GEN 4.1-4	15 DEC 11	ENR 1.3-6	15 DEC 11
GEN 4.2-1	15 DEC 11	ENR 1.3-7	15 DEC 11
GEN 4.2-2	15 DEC 11	ENR 1.3-8	15 DEC 11
		ENR 1.4-1	15 DEC 11
		ENR 1.4-2	15 DEC 11
		ENR 1.4-3	15 DEC 11
		ENR 1.4-4	15 DEC 11
		ENR 1.5-1	15 DEC 11
		ENR 1.5-2	15 DEC 11
		ENR 1.5-3	15 DEC 11
		ENR 1.5-4	15 DEC 11
		ENR 1.5-5	15 DEC 11
		ENR 1.5-6	15 DEC 11
		ENR 1.5-7	15 DEC 11
		ENR 1.5-8	15 DEC 11
		ENR 1.5-9	15 DEC 11
		ENR 1.5-10	15 DEC 11
		ENR 1.5-11	15 DEC 11
		ENR 1.5-12	15 DEC 11
		ENR 1.5-13	15 DEC 11
		ENR 1.5-14	15 DEC 11
		ENR 1.5-15	15 DEC 11
		ENR 1.5-16	2 APR 15
		ENR 1.5-17	15 DEC 11
		ENR 1.5-18	15 DEC 11
		ENR 1.5-19	31 MAR 16
		ENR 1.5-20	15 SEP 16
		ENR 1.5-21	31 MAR 16
		ENR 1.5-22	31 MAR 16
		ENR 1.5-23	8 NOV 18
		ENR 1.5-24	31 MAR 16
		ENR 1.6-1	15 DEC 11
		ENR 1.6-2	15 DEC 11
<b>ENROUTE</b>			
ENR 0.6-1	15 DEC 11		
ENR 0.6-2	15 DEC 11		
ENR 0.6-3	15 DEC 11		
ENR 0.6-4	31 MAR 16		
ENR 0.6-5	31 MAR 16		
ENR 0.6-6	31 MAR 16		
ENR 0.6-7	31 MAR 16		
ENR 0.6-8	31 MAR 16		
ENR 0.6-9	31 MAR 16		
ENR 0.6-10	12 NOV 15		
ENR 1-1	15 DEC 11		
ENR 1-2	15 DEC 11		
ENR 1.1-1	15 DEC 11		
ENR 1.1-2	15 DEC 11		
ENR 1.1-3	15 DEC 11		
ENR 1.1-4	15 DEC 11		
ENR 1.1-5	15 DEC 11		
ENR 1.1-6	15 DEC 11		
ENR 1.1-7	15 DEC 11		
ENR 1.1-8	15 DEC 11		
ENR 1.1-9	15 DEC 11		
ENR 1.1-10	15 DEC 11		
ENR 1.2-1	15 DEC 11		
ENR 1.2-2	15 DEC 11		
ENR 1.2-3	15 DEC 11		
ENR 1.2-4	15 DEC 11		
ENR 1.2-5	15 DEC 11		
ENR 1.2-6	15 DEC 11		

<b>Page No</b>	<b>Effective</b>	<b>Page No</b>	<b>Effective</b>
ENR 1.7-1	2 APR 15	ENR 1.15-3	12 NOV 15
ENR 1.7-2	2 APR 15	ENR 1.15-4	12 NOV 15
ENR 1.7-3	2 APR 15	ENR 1.15-5	12 NOV 15
ENR 1.7-4	2 APR 15	ENR 1.15-6	12 NOV 15
ENR 1.7-5	2 APR 15	ENR 1.15-7	12 NOV 15
ENR 1.7-6	15 DEC 11	ENR 1.15-8	12 NOV 15
ENR 1.8-1	15 DEC 11	ENR 1.15-9	12 NOV 15
ENR 1.8-2	15 DEC 11	ENR 1.15-10	12 NOV 15
ENR 1.9-1	15 DEC 11	ENR 1.15-11	12 NOV 15
ENR 1.9-2	15 DEC 11	ENR 1.15-12	12 NOV 15
ENR 1.10-1	15 DEC 11	ENR 1.15-13	12 NOV 15
ENR 1.10-2	15 DEC 11	ENR 1.15-14	12 NOV 15
ENR 1.10-3	15 DEC 11	ENR 2-1	15 DEC 11
ENR 1.10-4	15 DEC 11	ENR 2-2	15 DEC 11
ENR 1.10-5	15 DEC 11	ENR 2.1-1	2 APR 15
ENR 1.10-6	15 DEC 11	ENR 2.1-2	2 APR 15
ENR 1.10-7	15 DEC 11	ENR 2.1-3	2 APR 15
ENR 1.10-8	15 DEC 11	ENR 2.1-4	2 APR 15
ENR 1.10-9	15 DEC 11	ENR 2.1-5	30 APR 15
ENR 1.10-10	15 DEC 11	ENR 2.1-6	2 APR 15
ENR 1.10-11	15 DEC 11	ENR 2.2-1	15 DEC 11
ENR 1.10-12	15 DEC 11	ENR 2.2-2	15 DEC 11
ENR 1.10-13	15 DEC 11	ENR 3-1	15 DEC 11
ENR 1.10-14	15 DEC 11	ENR 3-2	15 DEC 11
ENR 1.10-15	15 DEC 11	ENR 3.1-1	15 DEC 11
ENR 1.10-16	15 DEC 11	ENR 3.1-2	15 DEC 11
ENR 1.10-17	15 DEC 11	ENR 3.2-1	15 DEC 11
ENR 1.10-18	15 DEC 11	ENR 3.2-2	15 DEC 11
ENR 1.11-1	15 DEC 11	ENR 3.3-1	15 DEC 11
ENR 1.11-2	15 DEC 11	ENR 3.3-2	15 DEC 11
ENR 1.12-1	15 DEC 11	ENR 3.4-1	15 DEC 11
ENR 1.12-2	15 DEC 11	ENR 3.4-2	15 DEC 11
ENR 1.12-3	15 DEC 11	ENR 3.5-1	15 DEC 11
ENR 1.12-4	15 DEC 11	ENR 3.5-2	15 DEC 11
ENR 1.13-1	15 DEC 11	ENR 3.6-1	15 DEC 11
ENR 1.13-2	15 DEC 11	ENR 3.6-2	15 DEC 11
ENR 1.14-1	15 DEC 11	ENR 4-1	15 DEC 11
ENR 1.14-2	15 DEC 11	ENR 4-2	15 DEC 11
ENR 1.15-1	12 NOV 15	ENR 4.1-1	2 APR 15
ENR 1.15-2	12 NOV 15	ENR 4.1-2	15 DEC 11



<b>Page No</b>	<b>Effective</b>	<b>Page No</b>	<b>Effective</b>
ENR 4.2-1	15 DEC 11	AD 1.4-1	2 APR 15
ENR 4.2-2	15 DEC 11	AD 1.4-2	30 APR 15
ENR 4.3-1	15 DEC 11	AD 1.5-1	15 DEC 11
ENR 4.3-2	15 DEC 11	AD 1.5-2	15 DEC 11
ENR 4.4-1	15 DEC 11	AD 1.6-1	15 DEC 11
ENR 4.4-2	15 DEC 11	AD 1.6-2	15 DEC 11
ENR 5-1	15 DEC 11	AD 1.7-1	15 DEC 11
ENR 5-2	15 DEC 11	AD 1.7-2	15 DEC 11
ENR 5.1-1	15 DEC 11	AD 1.7-3	15 DEC 11
ENR 5.1-2	15 DEC 11	AD 1.7-4	15 DEC 11
ENR 5.2-1	15 DEC 11	AD 1.7-5	15 DEC 11
ENR 5.2-2	15 DEC 11	AD 1.7-6	15 DEC 11
ENR 5.3-1	2 APR 15	AD 1.8-1	15 DEC 11
ENR 5.3-2	15 DEC 11	AD 1.8-2	15 DEC 11
ENR 5.4-1	15 DEC 11	AD 1.9-1	15 DEC 11
ENR 5.4-2	15 DEC 11	AD 1.9-2	15 DEC 11
ENR 5.5-1	15 DEC 11	AD 1.9-3	15 DEC 11
ENR 5.5-2	15 DEC 11	AD 1.9-4	15 DEC 11
ENR 5.6-1	15 DEC 11		
ENR 5.6-2	15 DEC 11		
ENR 6-1	15 DEC 11	<b>CHARTS</b>	
ENR 6-2	15 DEC 11	NCAI AD 2-1	8 NOV 18
ENR 6.1-1	15 DEC 11	NCAI AD 2-2	8 NOV 18
ENR 6.1-2	15 DEC 11	NCAI AD 2-3	15 DEC 11
ENR 6.1-3	15 DEC 11	NCAI AD 2-4	19 JUL 18
ENR 6.1-4	15 DEC 11	NCAI AD 2-5	30 APR 15
		NCAI AD 2-6	8 NOV 18
		NCAI AD 2-7	15 DEC 11
		NCAI AD 2-8	15 DEC 11
		NCAI AD 2-9	15 DEC 11
		NCAI AD 2-10	30 APR 15
		NCAI AD 2-11	30 APR 15
		NCAI AD 2-12	25 MAY 17
		NCAI AD 2-13	25 MAY 17
		NCAI AD 2-14	25 MAY 17
		NCAI AD 2-44.1	25 MAY 17
		Blank	
		NCAI AD 2-45.1	25 MAY 17
		NCAI AD 2-45.2	13 SEP 18
		NCAI AD 2-51.1	13 SEP 18
		Blank	
<b><u>AERODROME</u></b>			
AD 0.6-1	15 DEC 11		
AD 0.6-2	15 DEC 11		
AD 0.6-3	15 DEC 11		
AD 0.6-4	15 DEC 11		
AD 1-1	15 DEC 11		
AD 1-2	15 DEC 11		
AD 1.1-1	15 DEC 11		
AD 1.1-2	2 APR 15		
AD 1.2-1	15 DEC 11		
AD 1.2-2	15 DEC 11		
AD 1.3-1	30 APR 15		
AD 1.3-2	15 DEC 11		

<b>Page No</b>	<b>Effective</b>	<b>Page No</b>	<b>Effective</b>
NCAT AD 2-1	25 MAY 17	NCMK AD 2-5	19 JUL 18
NCAT AD 2-2	30 APR 15	NCMK AD 2-6	30 APR 15
NCAT AD 2-3	25 MAY 17	NCMK AD 2-7	30 APR 15
NCAT AD 2-4	15 DEC 11	NCMK AD 2-8	25 MAY 17
NCAT AD 2-5	25 MAY 17	NCMK AD 2-45.1	25 MAY 17
NCAT AD 2-6	30 APR 15	Blank	
NCAT AD 2-7	30 APR 15	NCMK AD 2-51.1	19 JUL 18
NCAT AD 2-8	25 MAY 17	Blank	
NCAT AD 2-45.1	25 MAY 17	NCMR AD 2-1	25 MAY 17
Blank		NCMR AD 2-2	30 APR 15
NCAT AD 2-51.1	25 MAY 17	NCMR AD 2-3	30 APR 15
Blank		NCMR AD 2-4	15 DEC 11
NCMG AD 2-1	19 JUL 18	NCMR AD 2-5	25 MAY 17
NCMG AD 2-2	30 APR 15	NCMR AD 2-6	30 APR 15
NCMG AD 2-3	25 MAY 17	NCMR AD 2-7	30 APR 15
NCMG AD 2-4	15 DEC 11	NCMR AD 2-8	25 MAY 17
NCMG AD 2-5	19 JUL 18	NCMR AD 2-45.1	25 MAY 17
NCMG AD 2-6	30 APR 15	Blank	
NCMG AD 2-7	30 APR 15	NCMR AD 2-51.1	25 MAY 17
NCMG AD 2-8	25 MAY 17	Blank	
NCMG AD 2-45.1	25 MAY 17	NCPY AD 2-1	6 DEC 18
Blank		NCPY AD 2-2	30 APR 15
NCMG AD 2-51.1	25 MAY 17	NCPY AD 2-3	15 DEC 11
Blank		NCPY AD 2-4	15 DEC 11
NCMH AD 2-1	6 DEC 18	NCPY AD 2-5	6 DEC 18
NCMH AD 2-2	30 APR 15	NCPY AD 2-6	30 APR 15
NCMH AD 2-3	30 APR 15	NCPY AD 2-7	6 DEC 18
NCMH AD 2-4	15 DEC 11	NCPY AD 2-8	6 DEC 18
NCMH AD 2-5	6 DEC 18	NCPY AD 2-44.1	6 DEC 18
NCMH AD 2-6	30 APR 15	Blank	
NCMH AD 2-7	30 APR 15	NCPY AD 2-45.1	6 DEC 18
NCMH AD 2-8	6 DEC 18	Blank	6 DEC 18
NCMH AD 2-45.1	6 DEC 18	NCPY AD 2-51.1	6 DEC 18
NCMH AD 2-45.2	6 DEC 18	Blank	
NCMH AD 2-51.1	6 DEC 18	NCPK AD 2-1	6 DEC 18
Blank		NCPK AD 2-2	30 APR 15
NCMK AD 2-1	25 MAY 17	NCPK AD 2-3	15 DEC 11
NCMK AD 2-2	30 APR 15	NCPK AD 2-4	15 DEC 11
NCMK AD 2-3	25 MAY 17	NCPK AD 2-5	6 DEC 18
NCMK AD 2-4	15 DEC 11	NCPK AD 2-6	30 APR 15

<b>Page No</b>	<b>Effective</b>	<b>Page No</b>	<b>Effective</b>
NCPK AD 2-7	30 APR 15	NCRG AD 2-33.1	13 SEP 18
NCPK AD 2-8	6 DEC 18	NCRG AD 2-33.2	13 SEP 18
NCPK AD 2-45.1	6 DEC 18	NCRG AD 2-41.1	8 NOV 18
Blank		NCRG AD 2-41.2	8 NOV 18
NCPK AD 2-51.1	6 DEC 18	NCRG AD 2-43.1	8 NOV 18
Blank		NCRG AD 2-43.2	8 NOV 18
NCRG AD 2-1	8 NOV 18	NCRG AD 2-43.3	8 NOV 18
NCRG AD 2-2	8 NOV 18	Blank	
NCRG AD 2-3	8 NOV 18	NCRG AD 2-44.1	8 NOV 18
NCRG AD 2-4	8 NOV 18	Blank	
NCRG AD 2-5	8 NOV 18	NCRG AD 2-45.1	19 JUL 18
NCRG AD 2-6	15 DEC 11	NCRG AD 2-45.2	19 JUL 18
NCRG AD 2-7	19 JUL 18	NCRG AD 2-45.3	19 JUL 18
NCRG AD 2-8	13 SEP 18	NCRG AD 2-45.4	19 JUL 18
NCRG AD 2-9	2 APR 15	NCRG AD 2-45.5	19 JUL 18
NCRG AD 2-10	8 NOV 18	NCRG AD 2-45.6	19 JUL 18
NCRG AD 2-11	2 APR 15	NCRG AD 2-51.1	13 SEP 18
NCRG AD 2-12	19 JUL 18	NCRG AD 2-53.1	13 SEP 18
NCRG AD 2-13	2 APR 15	NCRG AD 2-62.1	13 SEP 18
NCRG AD 2-14	15 DEC 11	Blank	
NCRG AD 2-15	8 NOV 18		
NCRG AD 2-16	13 SEP 18		

# **Intentionally Blank**

**GEN 0.6 TABLE OF CONTENTS — GEN**

	<b><u>Page No.</u></b>
<b>GEN 0.1 PREFACE</b> .....	<b>GEN 0.1 - 1</b>
1 Provision of the AIP — Cook Islands .....	GEN 0.1 - 1
1.1 General .....	GEN 0.1 - 1
2 Publishing Authority .....	GEN 0.1 - 1
2.1 Authority .....	GEN 0.1 - 1
2.2 Publisher .....	GEN 0.1 - 2
3 Applicable ICAO Documents .....	GEN 0.1 - 2
3.1 General .....	GEN 0.1 - 2
4 AIP Structure and Amendment Interval .....	GEN 0.1 - 4
4.1 General .....	GEN 0.1 - 4
<i>Table GEN 0.1-1</i>	
<i>Amendment Schedule</i> .....	<i>GEN 0.1 - 4</i>
4.2 Amendments .....	GEN 0.1 - 5
4.3 Amendment Bulletin .....	GEN 0.1 - 5
4.4 Annotation of Amendments .....	GEN 0.1 - 5
4.5 Nil Amendment Notification .....	GEN 0.1 - 5
5 Notification of Errors and Omissions .....	GEN 0.1 - 5
5.1 General .....	GEN 0.1 - 5
<b>GEN 0.2 RECORD OF AIP AMENDMENTS</b> .....	<b>GEN 0.2 - 1</b>
1 AIP Amendment Dates .....	GEN 0.2 - 1
1.1 General .....	GEN 0.2 - 1
<i>Table GEN 0.2-1</i>	
<i>Record of Amendments</i> .....	<i>GEN 0.2 - 1</i>
<b>GEN 0.3 RECORD OF AIP SUPPLEMENTS</b> .....	<b>GEN 0.3 - 1</b>
1 AIP Supplements .....	GEN 0.3 - 1
1.1 General .....	GEN 0.3 - 1
<i>Table GEN 0.3-1</i>	
<i>Record of Supplements</i> .....	<i>GEN 0.3 - 1</i>
<b>GEN 0.4 CHECKLIST OF AIP PAGES</b> .....	<b>GEN 0.4 - 1</b>
<b>GEN 0.6 TABLE OF CONTENTS — GEN</b> .....	<b>GEN 0.6 - 1</b>
<b>GEN 1 NATIONAL REGULATIONS AND REQUIREMENTS</b> .....	<b>GEN 1 - 1</b>
<b>GEN 1.1 DESIGNATED AUTHORITIES</b> .....	<b>GEN 1.1 - 1</b>
1 Ministry of Transport .....	GEN 1.1 - 1
1.1 General .....	GEN 1.1 - 1
2 Designated Authorities .....	GEN 1.1 - 2
2.1 Addressees of Designated Authorities .....	GEN 1.1 - 2

<b>GEN 1.2 ENTRY, TRANSIT AND DEPARTURE OF AIRCRAFT</b>	<b>GEN 1.2 - 1</b>
1 Introduction	GEN 1.2 - 1
1.1 General	GEN 1.2 - 1
2 Relevant Legislation	GEN 1.2 - 1
2.1 Cook Islands Legislation	GEN 1.2 - 1
3 Ministry of Transport Requirements	GEN 1.2 - 2
3.1 Scheduled Air Services	GEN 1.2 - 2
3.2 Non-Scheduled Flights	GEN 1.2 - 2
3.3 Commercial Flights	GEN 1.2 - 2
3.4 Non-Commercial Flights	GEN 1.2 - 2
3.5 Applications for Approval	GEN 1.2 - 3
4 Scheduled and Non-Scheduled Flights	GEN 1.2 - 5
4.1 General	GEN 1.2 - 5
4.2 Documentary Requirements for Clearance of Aircraft	GEN 1.2 - 5
<i>Table GEN 1.2-1</i>	
<i>Aircraft Documents Required</i>	<i>GEN 1.2 - 5</i>
5 Requirements For Clearance of Aircraft	GEN 1.2 - 7
5.1 Arrival	GEN 1.2 - 7
5.2 Departure	GEN 1.2 - 7
6 Military and State Aircraft	GEN 1.2 - 8
6.1 General	GEN 1.2 - 8
7 Private Flights	GEN 1.2 - 8
7.1 General	GEN 1.2 - 8
8 Public Health Measures Applied to Aircraft	GEN 1.2 - 8
8.1 General	GEN 1.2 - 8
<b>GEN 1.3 ENTRY, TRANSIT AND DEPARTURE OF PASSENGERS AND CREW</b>	<b>GEN 1.3 - 1</b>
1 Introduction	GEN 1.3 - 1
1.1 General	GEN 1.3 - 1
2 Customs Requirements	GEN 1.3 - 1
2.1 General	GEN 1.3 - 1
3 Immigration Requirements	GEN 1.3 - 2
3.1 General	GEN 1.3 - 2
3.2 Passports	GEN 1.3 - 2
3.3 Visas	GEN 1.3 - 3
4 Public Health Requirements	GEN 1.3 - 4
4.1 General	GEN 1.3 - 4
4.2 Responsibilities of Pilot In Command	GEN 1.3 - 4

**Page No.**

<b>GEN 1.4</b>	<b>ENTRY, TRANSIT AND DEPARTURE OF CARGO . GEN 1.4 - 1</b>	
1	Customs Requirements Concerning Cargo and Other Articles .....	GEN 1.4 - 1
1.1	General .....	GEN 1.4 - 1
2	Agricultural Quarantine Requirements .....	GEN 1.4 - 1
2.1	Airport Facilities .....	GEN 1.4 - 1
<b>GEN 1.5</b>	<b>AIRCRAFT INSTRUMENTS, EQUIPMENT AND FLIGHT DOCUMENTS .....</b>	<b>GEN 1.5 - 1</b>
1	Commercial Air Transport Aircraft .....	GEN 1.5 - 1
1.1	General .....	GEN 1.5 - 1
2	Special Equipment to be Carried .....	GEN 1.5 - 1
2.1	General .....	GEN 1.5 - 1
3	Carriage of Survival Radio in Cook Islands Airspace ..	GEN 1.5 - 1
3.1	General .....	GEN 1.5 - 1
<b>GEN 1.6</b>	<b>SUMMARY OF NATIONAL REGULATIONS AND INTERNATIONAL AGREEMENTS/CONVENTIONS . GEN 1.6 - 1</b>	
1	National Regulations .....	GEN 1.6 - 1
1.1	General .....	GEN 1.6 - 1
2	International Agreements/Conventions .....	GEN 1.6 - 1
2.1	Conventions and Protocols .....	GEN 1.6 - 1
2.2	International Agreements .....	GEN 1.6 - 2
<b>GEN 1.7</b>	<b>DIFFERENCES FROM ICAO STANDARDS, RECOMMENDED PRACTICES AND PROCEDURES .....</b>	<b>GEN 1.7 - 1</b>
1	Annex 1 — Personnel Licensing .....	GEN 1.7 - 1
2	Annex 2 — Rules of the Air .....	GEN 1.7 - 1
3	Annex 3 — Meteorology .....	GEN 1.7 - 1
4	Annex 7 — Aircraft Nationality and Registration Marks .....	GEN 1.7 - 1
5	Annex 8 — Airworthiness of Aircraft .....	GEN 1.7 - 1
6	Annex 9 — Facilitation .....	GEN 1.7 - 1
7	Annex 10 — Aeronautical Telecommunications .....	GEN 1.7 - 1
8	Annex 11 — Air Traffic Services .....	GEN 1.7 - 1
9	Annex 12 — Search and Rescue .....	GEN 1.7 - 2
10	Annex 13 — Aircraft Accident .....	GEN 1.7 - 2
11	Annex 14 — Aerodromes .....	GEN 1.7 - 2
12	Annex 15 — Aeronautical Information Services .....	GEN 1.7 - 2
13	Annex 16 — Environmental Protection .....	GEN 1.7 - 2
14	Annex 17 — Security — Safeguarding International Civil Aviation Against Acts of Unlawful Interference ..	GEN 1.7 - 2
15	Annex 18 — The Safe Transport of Dangerous Goods by Air .....	GEN 1.7 - 2

**GEN 2 TABLES AND CODES ..... GEN 2 - 1**

**GEN 2.1 MEASURING SYSTEM, AIRCRAFT MARKINGS, HOLIDAYS ..... GEN 2.1 - 1**

1 Units of Measurement ..... GEN 2.1 - 1

    1.1 General ..... GEN 2.1 - 1

*Table GEN 2.1-1*  
    *Units of Measurement* ..... GEN 2.1 - 1

2 Time System ..... GEN 2.1 - 2

    2.1 General ..... GEN 2.1 - 2

    2.2 Time Signals ..... GEN 2.1 - 2

3 Geodetic Reference Datum ..... GEN 2.1 - 2

    3.1 Name/Designation of Datum ..... GEN 2.1 - 2

    3.2 Area of Application ..... GEN 2.1 - 2

    3.3 Use of an Asterisk to Identify Published Geographical Coordinates ..... GEN 2.1 - 2

4 Aircraft Nationality and Registration Marks ..... GEN 2.1 - 3

    4.1 General ..... GEN 2.1 - 3

5 Public Holidays ..... GEN 2.1 - 3

    5.1 General ..... GEN 2.1 - 3

*Table GEN 2.1-2*  
    *Public Holidays* ..... GEN 2.1 - 3

**GEN 2.2 ABBREVIATIONS USED IN AIS PUBLICATIONS .. GEN 2.2 - 1**

1 Introduction ..... GEN 2.2 - 1

    1.1 General ..... GEN 2.2 - 1

**GEN 2.3 CHART SYMBOLS ..... GEN 2.3 - 1**

1 Introduction ..... GEN 2.3 - 1

    1.1 General ..... GEN 2.3 - 1

*Figure GEN 2.3-1*  
    *Aerodrome Chart Symbols* ..... GEN 2.3 - 2

*Figure GEN 2.3-2*  
    *Aerodrome Chart Symbols* ..... GEN 2.3 - 3

*Figure GEN 2.3-3*  
    *Airspace and Navigation Chart Symbols* ..... GEN 2.3 - 4

*Figure GEN 2.3-4*  
    *Instrument Chart Symbols* ..... GEN 2.3 - 5

*Figure GEN 2.3-5*  
    *Instrument Chart Symbols* ..... GEN 2.3 - 6

*Figure GEN 2.3-6*  
    *Instrument Chart Symbols* ..... GEN 2.3 - 7

*Figure GEN 2.3-7*  
    *Instrument Chart Symbols* ..... GEN 2.3 - 8

*Figure GEN 2.3-8*  
    *Instrument Chart Symbols* ..... GEN 2.3 - 9

*Figure GEN 2.3-9*  
    *Ground Based Aid Approach* ..... GEN 2.3 - 10



**Page No.**

<b>GEN 2.4 LOCATION INDICATORS .....</b>	<b>GEN 2.4 - 1</b>
1 Introduction .....	GEN 2.4 - 1
1.1 General .....	GEN 2.4 - 1
1.2 AFS Addresses .....	GEN 2.4 - 1
<i>Table GEN 2.4-1</i>	
<i>AFS Address Encode/Decode .....</i>	<i>GEN 2.4 - 1</i>
<b>GEN 2.5 LIST OF RADIO NAVIGATION AIDS .....</b>	<b>GEN 2.5 - 1</b>
1 Radio Navigation Aids .....	GEN 2.5 - 1
1.1 Decode .....	GEN 2.5 - 1
<i>Table GEN 2.5-1</i>	
<i>List of Radio Navigation Aids by ID .....</i>	<i>GEN 2.5 - 1</i>
1.2 Encode .....	GEN 2.5 - 2
<i>Table GEN 2.5-2</i>	
<i>List of Radio Navigation Aids by Location .....</i>	<i>GEN 2.5 - 2</i>
<b>GEN 2.6 CONVERSION TABLES .....</b>	<b>GEN 2.6 - 1</b>
1 Conversion Tables .....	GEN 2.6 - 1
1.1 Unit Conversions .....	GEN 2.6 - 1
<i>Table GEN 2.6-1</i>	
<i>Unit Conversions .....</i>	<i>GEN 2.6 - 1</i>
<b>GEN 2.7 SUNSET/SUNRISE TABLES .....</b>	<b>GEN 2.7 - 1</b>
1 Sunset/Sunrise Tables .....	GEN 2.7 - 1
1.1 General .....	GEN 2.7 - 1
<i>Table GEN 2.7-1</i>	
<i>Morning Civil Twilight/Evening Civil Twilight .....</i>	<i>GEN 2.7 - 1</i>

<b>GEN 3</b>	<b>SERVICES .....</b>	<b>GEN 3 - 1</b>
<b>GEN 3.1</b>	<b>AERONAUTICAL INFORMATION SERVICES .....</b>	<b>GEN 3.1 - 1</b>
1	Responsible Service .....	GEN 3.1 - 1
1.1	General .....	GEN 3.1 - 1
1.2	Aeronautical Information Service Providers .....	GEN 3.1 - 1
1.3	International NOTAM Office (NOF) .....	GEN 3.1 - 2
2	Area of Responsibility .....	GEN 3.1 - 2
2.1	General .....	GEN 3.1 - 2
3	Aeronautical Publications .....	GEN 3.1 - 3
3.1	General .....	GEN 3.1 - 3
3.2	Aeronautical Information Publication .....	GEN 3.1 - 3
3.3	Supplements to the AIP .....	GEN 3.1 - 3
3.4	NOTAM and Pre-flight Information Bulletins (PIB) .....	GEN 3.1 - 4
3.5	Aeronautical Information Circulars .....	GEN 3.1 - 4
3.6	Checklists and Summary of NOTAM .....	GEN 3.1 - 5
3.7	Sale of Publications .....	GEN 3.1 - 5
4	Airac System .....	GEN 3.1 - 5
4.1	General .....	GEN 3.1 - 5
5	Pre-Flight Information Service at Aerodromes .....	GEN 3.1 - 6
5.1	General .....	GEN 3.1 - 6
<b>GEN 3.2</b>	<b>AERONAUTICAL CHARTS .....</b>	<b>GEN 3.2 - 1</b>
1	Responsible Service .....	GEN 3.2 - 1
1.1	General .....	GEN 3.2 - 1
2	Maintenance of Charts .....	GEN 3.2 - 1
2.1	General .....	GEN 3.2 - 1
2.2	Purchase Arrangements .....	GEN 3.2 - 1
2.3	Aeronautical Chart Series Available .....	GEN 3.2 - 1
2.4	List of Aeronautical Charts Available .....	GEN 3.2 - 1
2.5	Index to the World Aeronautical Charts (WAC) — ICAO 1:1 000 000 .....	GEN 3.2 - 1
2.6	Topographical Charts .....	GEN 3.2 - 2
2.7	Corrections to Charts not Contained in the AIP .	GEN 3.2 - 2

**Page No.**

<b>GEN 3.3 AIR TRAFFIC SERVICES .....</b>	<b>GEN 3.3 - 1</b>
1 Responsible Service .....	GEN 3.3 - 1
1.1 General .....	GEN 3.3 - 1
2 Area of Responsibility .....	GEN 3.3 - 1
2.1 General .....	GEN 3.3 - 1
3 Types of Services .....	GEN 3.3 - 2
3.1 General .....	GEN 3.3 - 2
3.2 ATC Contingency Service .....	GEN 3.3 - 2
4 Co-ordination Between the Operators and ATS .....	GEN 3.3 - 3
4.1 General .....	GEN 3.3 - 3
5 ATS Units Address List .....	GEN 3.3 - 3
5.1 General .....	GEN 3.3 - 3
<i>Table GEN 3.3-1</i>	
<i>ATS Unit Contact Addresses .....</i>	
	<i>GEN 3.3 - 3</i>
6 Minimum Flight Altitude .....	GEN 3.3 - 4
6.1 Minimum Safe Altitude .....	GEN 3.3 - 4
6.2 Minimum Reception Altitude and Minimum Enroute Altitude .....	GEN 3.3 - 4
6.3 Minimum Flight Altitude .....	GEN 3.3 - 5
<i>Figure GEN 3.3-1</i>	
<i>Minimum Flight Altitude .....</i>	
	<i>GEN 3.3 - 5</i>
6.4 Climb to MFA .....	GEN 3.3 - 6
6.5 Descent Below MFA .....	GEN 3.3 - 6
6.6 Emergency Descent Below MFA .....	GEN 3.3 - 6
<b>GEN 3.4 COMMUNICATION SERVICES .....</b>	<b>GEN 3.4 - 1</b>
1 Responsible Service .....	GEN 3.4 - 1
1.1 General .....	GEN 3.4 - 1
2 Area of Responsibility .....	GEN 3.4 - 2
2.1 General .....	GEN 3.4 - 2
3 Types of Service .....	GEN 3.4 - 2
3.1 Radio Navigation Services .....	GEN 3.4 - 2
3.2 Mobile/Fixed Service .....	GEN 3.4 - 2
3.3 Broadcasting Service .....	GEN 3.4 - 3
3.4 Language Used .....	GEN 3.4 - 3
3.5 Where Detailed Information can be Obtained ...	GEN 3.4 - 3
3.6 Hours of Service .....	GEN 3.4 - 3
3.7 Extended Service .....	GEN 3.4 - 4
4 Requirements and Conditions .....	GEN 3.4 - 4
4.1 General .....	GEN 3.4 - 4
5 AFTN Circuits .....	GEN 3.4 - 5
5.1 General .....	GEN 3.4 - 5
<i>Figure GEN 3.4-1</i>	
<i>AFTN Circuits .....</i>	
	<i>GEN 3.4 - 5</i>

	<u>Page No.</u>
6 ATS Speech Circuits .....	GEN 3.4 - 6
6.1 General .....	GEN 3.4 - 6
<i>Figure GEN 3.4-2</i>	
<i>AFTN Speech Circuits</i> .....	<i>GEN 3.4 - 6</i>
<b>GEN 3.5 METEOROLOGICAL SERVICES .....</b>	<b>GEN 3.5 - 1</b>
1 Responsible Service .....	GEN 3.5 - 1
1.1 General .....	GEN 3.5 - 1
2 Area of Responsibility .....	GEN 3.5 - 1
2.1 General .....	GEN 3.5 - 1
3 Meteorological Observations and Reports .....	GEN 3.5 - 2
3.1 Description of Observation System .....	GEN 3.5 - 2
<i>Table GEN 3.5-1</i>	
<i>Meteorological Observations and Reports</i> .....	<i>GEN 3.5 - 5</i>
4 Types of Services .....	GEN 3.5 - 6
4.1 General .....	GEN 3.5 - 6
5 Notification Required From Operators .....	GEN 3.5 - 6
5.1 General .....	GEN 3.5 - 6
6 Aircraft Reports .....	GEN 3.5 - 7
6.1 General .....	GEN 3.5 - 7
7 Volmet Service .....	GEN 3.5 - 7
7.1 General .....	GEN 3.5 - 7
8 Sigmet Service .....	GEN 3.5 - 7
8.1 General .....	GEN 3.5 - 7
9 Other Automated Meteorological Services .....	GEN 3.5 - 7
9.1 General .....	GEN 3.5 - 7
<b>GEN 3.6 SEARCH AND RESCUE .....</b>	<b>GEN 3.6 - 1</b>
1 Responsible Services .....	GEN 3.6 - 1
1.1 General .....	GEN 3.6 - 1
2 Area of Responsibility .....	GEN 3.6 - 1
2.1 General .....	GEN 3.6 - 1
3 Types of Service .....	GEN 3.6 - 1
3.1 General .....	GEN 3.6 - 1
3.2 Search and Rescue Units .....	GEN 3.6 - 2
<i>Table GEN 3.6-1</i>	
<i>Search and Rescue Units</i> .....	<i>GEN 3.6 - 2</i>
4 SAR Agreements .....	GEN 3.6 - 2
4.1 General .....	GEN 3.6 - 2
5 Conditions of Availability .....	GEN 3.6 - 2
5.1 General .....	GEN 3.6 - 2

	<b>Page No.</b>
6 Procedures and Signals Used .....	GEN 3.6 - 3
6.1 Procedures and Signals Used by Aircraft .....	GEN 3.6 - 3
6.2 Communications .....	GEN 3.6 - 3
6.3 Procedures for an Aircraft Requiring SAR Escort .....	GEN 3.6 - 3
6.4 RTF Procedures .....	GEN 3.6 - 4
6.5 RTF Distress Communications .....	GEN 3.6 - 4
6.6 Imposition of Silence .....	GEN 3.6 - 6
6.7 Action by all Other Stations .....	GEN 3.6 - 6
6.8 Termination of Distress Communication and of Silence .....	GEN 3.6 - 6
6.9 RTF Urgency Communication .....	GEN 3.6 - 7
6.10 Action by all Other Stations .....	GEN 3.6 - 8
6.11 Procedures for a Pilot-in-Command Observing a Distress Incident .....	GEN 3.6 - 8
6.12 Procedures for a Pilot-in-Command Intercepting a Distress Message .....	GEN 3.6 - 9
6.13 Non-Radio Distress and Urgency Signals .....	GEN 3.6 - 9
<i>Table GEN 3.6-2</i>	
<i>Ground/Air Visual Signal Codes .....</i>	<i>GEN 3.6 - 10</i>
6.14 Procedure for Directing a Surface Craft to a Distress Incident .....	GEN 3.6 - 11
6.15 Current Maritime Signalling Procedures .....	GEN 3.6 - 12
6.16 Procedure to Signify that Assistance from a Surface Craft is no Longer Required .....	GEN 3.6 - 12
7 Visual Inspections by ATS Unit .....	GEN 3.6 - 12
7.1 General .....	GEN 3.6 - 12
8 Emergency Locator Transmitters (ELT) .....	GEN 3.6 - 13
8.1 General .....	GEN 3.6 - 13
8.2 Emergency Activation .....	GEN 3.6 - 13
8.3 Emergency Location Transmitter Reporting Procedures .....	GEN 3.6 - 13
8.4 ELT Testing .....	GEN 3.6 - 14
8.5 Inadvertent Activation .....	GEN 3.6 - 14
9 Aerodrome Emergencies .....	GEN 3.6 - 15
9.1 Aerodrome Emergency Plan .....	GEN 3.6 - 15
9.2 Procedures to Activate Aerodrome Emergency Services .....	GEN 3.6 - 16

<b>GEN 4</b>	<b>CHARGES FOR AERODROMES/HELIPORTS AND AIR NAVIGATION SERVICES .....</b>	<b>GEN 4 - 1</b>
<b>GEN 4.1</b>	<b>AERODROME CHARGES .....</b>	<b>GEN 4.1 - 1</b>
1	Aerodrome Charges .....	GEN 4.1 - 1
1.1	General .....	GEN 4.1 - 1
1.2	Landing Charges .....	GEN 4.1 - 1
	<i>Table GEN 4.1-1</i>	
	<i>Landing Charges .....</i>	<i>GEN 4.1 - 1</i>
2	Exemptions and Reductions .....	GEN 4.1 - 2
2.1	Exemptions .....	GEN 4.1 - 2
2.2	Reductions .....	GEN 4.1 - 2
2.3	Surcharges .....	GEN 4.1 - 2
2.4	Cargo .....	GEN 4.1 - 2
3	Methods of Payment .....	GEN 4.1 - 2
3.1	General .....	GEN 4.1 - 2
<b>GEN 4.2</b>	<b>AIR NAVIGATION CHARGES .....</b>	<b>GEN 4.2 - 1</b>
1	Charges .....	GEN 4.2 - 1
1.1	General .....	GEN 4.2 - 1
2	Exemptions/Reductions .....	GEN 4.2 - 1
2.1	General .....	GEN 4.2 - 1
3	Methods of Payment .....	GEN 4.2 - 1
3.1	General .....	GEN 4.2 - 1

# **GEN 1 NATIONAL REGULATIONS AND REQUIREMENTS**





## GEN 1.1 DESIGNATED AUTHORITIES

### 1 MINISTRY OF TRANSPORT

#### 1.1 General

1.1.1 The Ministry of Transport is the agency responsible for coordination of Cook Islands obligations under the provision of ICAO Annex 9: Facilitation. The Ministry is responsible for coordinating with other agencies charged with the development and implementation of policy on passenger and cargo processing at Rarotonga International Airport.

#### **Civil Aviation Regulatory & Operations**

Secretary for Transport  
Ministry of Transport  
PO Box 61  
Rarotonga  
COOK ISLANDS

TEL +682 28810  
FAX +682 28816

AFTN NCRGYAYX  
Email [transport@cookislands.gov.ck](mailto:transport@cookislands.gov.ck)  
Website [www.transport.gov.ck](http://www.transport.gov.ck)

After hours: Ned Howard  
[ned.howard@cookislands.gov.ck](mailto:ned.howard@cookislands.gov.ck)  
Tel +682 53810

Johnny Hosking  
[john.hosking@cookislands.gov.ck](mailto:john.hosking@cookislands.gov.ck)  
Tel +682 54180

## 2 DESIGNATED AUTHORITIES

### 2.1 Addressees of Designated Authorities

2.1.1 The addressees of the designated authorities concerned with the facilitation of international air navigation are:

#### **Civil Aviation:**

Director of Civil Aviation  
Ministry of Transport  
PO Box 61  
Rarotonga  
COOK ISLANDS

FAX +682 28816  
AFTN NCRGYAYX  
Email [dennis.hoskin@cookislands.gov.ck](mailto:dennis.hoskin@cookislands.gov.ck) or  
[hoskinconsultantltd@xtra.co.nz](mailto:hoskinconsultantltd@xtra.co.nz)  
Website [www.transport.gov.ck](http://www.transport.gov.ck)

#### (a) Cook Islands Airport Authority

Chief Executive  
Airport Authority  
PO Box 90  
Rarotonga International Airport  
COOK ISLANDS

TEL +682 25890 ext 204  
FAX +682 21890  
AFTN NCRGYDYX  
Email [jngamata@airport.gov.ck](mailto:jngamata@airport.gov.ck)

#### (b) Meteorology

Cook Islands Meteorological Service  
PO Box 127  
Rarotonga  
COOK ISLANDS

TEL +682 20603  
FAX +682 21603  
AFTN NCRGYMYX  
Email [mot.weather@cookislands.gov.ck](mailto:mot.weather@cookislands.gov.ck)  
Website [www.cookislands.pacificweather.org](http://www.cookislands.pacificweather.org)

**(c) Customs**

The Collector of Customs  
Customs Department  
PO Box 120  
Rarotonga  
COOK ISLANDS

TEL +682 29365  
FAX +682 29465  
Email [customs.info@cookislands.gov.ck](mailto:customs.info@cookislands.gov.ck)  
Website [www.mfem.gov.ck](http://www.mfem.gov.ck)

**(d) Immigration**

Principal Immigration Officer  
Ministry of Foreign Affairs and Immigration (MFAI)  
PO Box 105  
Rarotonga  
COOK ISLANDS

TEL +682 29347  
FAX +682 21247  
Email [secfa@cookislands.gov.ck](mailto:secfa@cookislands.gov.ck)  
Website [www.mfai.gov.ck](http://www.mfai.gov.ck)

**(e) Health**

Public Health  
Ministry of Health  
PO Box 109  
Rarotonga  
COOK ISLANDS

TEL +682 29110  
FAX +682 29100  
Email [aremaki@health.gov.ck](mailto:aremaki@health.gov.ck)  
Website [www.health.gov.ck](http://www.health.gov.ck)

**(f) Agricultural Quarantine (Biosecurity)**

Chief Quarantine Officer  
Ministry of Agriculture  
PO Box 96  
Rarotonga  
COOK ISLANDS

TEL +682 28710 or 28711  
FAX +682 21881  
Email [agriculture@biosecurity.gov.ck](mailto:agriculture@biosecurity.gov.ck)  
Website [www.agriculture.gov.ck](http://www.agriculture.gov.ck)

**(g) Aviation Security**

Chief Aviation Security Officer (CASO)  
Airport Authority  
PO Box 90  
Rarotonga International Airport  
COOK ISLANDS

TEL +682 25890 ext 205  
FAX +682 21890  
Email [tanq@airport.gov.ck](mailto:tanq@airport.gov.ck)

**(h) Diplomatic Clearance**

Director Protocol Division  
Ministry of Foreign Affairs and Immigration (MFAI)  
PO Box 105  
Rarotonga  
COOK ISLANDS

TEL +682 29347  
FAX +682 29465  
Email [secfa@cookislands.gov.ck](mailto:secfa@cookislands.gov.ck) or [admin@hicom.org.nz](mailto:admin@hicom.org.nz)  
Website [www.mfai.gov.ck](http://www.mfai.gov.ck)

**(i) Enroute and Aerodrome Charges**

Director of Corporate  
Airport Authority  
PO Box 90  
Rarotonga International Airport  
COOK ISLANDS

TEL +682 25890  
FAX +682 21890  
AFTN NCRGYDYX  
Email [florence@cookislands.gov.ck](mailto:florence@cookislands.gov.ck)

**(j) Aircraft Accidents Investigation**

The Secretary for Transport\*  
Ministry of Transport  
PO Box 61  
Rarotonga  
COOK ISLANDS

TEL +682 28810  
FAX +682 28816  
Email [ned.howard@cookislands.gov.ck](mailto:ned.howard@cookislands.gov.ck) or  
[transport@cookislands.gov.ck](mailto:transport@cookislands.gov.ck)

\*The Minister of Transport must appoint a Chief Accident Investigator when this is recommended by the Secretary for Transport.

The functions of the Chief Accident Investigator are defined in the Civil Aviation Act 2002.

# **Intentionally Blank**

## **GEN 1.2 ENTRY, TRANSIT AND DEPARTURE OF AIRCRAFT**

### **1 INTRODUCTION**

#### **1.1 General**

1.1.1 International flights into, from, or in transit through the Cook Islands territory is subject to the current Cook Islands Civil Aviation Act 2002 and Air Services Act 1984 and associated Rules and Regulations relating to civil aviation. These regulations correspond in all essentials to the Standards and Recommended Practices contained in Annex 9 to the Convention on International Civil Aviation. The information contained in this section does not replace, amend or change in any manner, the current regulations of the designated authorities that are of concern to international air travel.

1.1.2 Aircraft flying into or departing from Cook Islands territory shall make their first landing at, or final departure from Rarotonga International Airport.

1.1.3 With the exception to the above, Aitutaki airport may be used as a port of entry and departure for light to medium wake turbulence category aircraft that are in compliance with Aitutaki Pavement Classification Number (PCN) requirements. Aircraft exceeding this may not be permitted to land and will require specific approval from the Cook Islands Airport Authority. Refer Para 3.5.3 for request approval requirements.

### **2 RELEVANT LEGISLATION**

#### **2.1 Cook Islands Legislation**

2.1.1 The primary customs, immigration, quarantine, agriculture and health legislation is listed as below:

- (a) Customs Revenue and Border Protection Act, associated Regulations and Explanatory Notes 2012
- (b) Entry, Residence and Departure Act 1971–1972 and associated amendments
- (c) Biosecurity Act 2008 and associated quarantine regulations
- (d) Public Health Act 2004
- (e) Plant Act 1973 and Animal Act 1975
- (f) Te Pakau Aroa Act 2005
- (g) Departure Tax Act 2012

**D**

### **3 MINISTRY OF TRANSPORT REQUIREMENTS**

#### **3.1 Scheduled Air Services**

3.1.1 International airlines serving the Cook Islands on a scheduled basis are required to hold an International Air Service Licence.

#### **3.2 Non-Scheduled Flights**

3.2.1 Non-scheduled flights are all international flights other than scheduled air services, and include charter, ferry, medivac/retrieval and private flights.

#### **3.3 Commercial Flights**

3.3.1 Commercial non-scheduled flights transiting Cook Islands territory, and not landing at Rarotonga International airport do not require authorization by the Director of Civil Aviation. Advance notice is required. An international flight plan will be accepted as advance notice.

#### **3.4 Non-Commercial Flights**

3.4.1 Operators of civil aircraft registered in States party to the Convention on International Civil Aviation desiring to make non-scheduled flights in transit across Cook Islands territory are only required to give advance notice. An international flight plan will be accepted as adequate notice. If the flight is to land at Rarotonga International airport for non-commercial purposes, this requires authorization from the Director of Civil Aviation.



### 3.5 Applications for Approval

3.5.1 Applications for non-scheduled commercial flights, which must be from the operator (not the charterer) may be made directly to the Ministry of Transport. If, however the aircraft is not registered in a State party to the ICAO Convention, the application should be submitted through the aviation authority of the State of Registry.

3.5.2 Application and notice of flights should be addressed to:

Director of Civil Aviation  
Ministry of Transport  
PO Box 61  
Rarotonga  
COOK ISLANDS

Tel +682 28810  
Fax +682 28816  
Email [dennis.hoskin@cookislands.gov.ck](mailto:dennis.hoskin@cookislands.gov.ck) or  
[hoskinconsultantltd@xtra.co.nz](mailto:hoskinconsultantltd@xtra.co.nz) and  
[tai.cummings@cookislands.gov.ck](mailto:tai.cummings@cookislands.gov.ck)

Note: The Ministry of Transport does not have AFTN or SITA links; however, messages received from via the Cook Islands Airport Authority will be directed onwards to the Ministry.

After hours:

Ned Howard mobile: +682 53810  
Johnny Hosking mobile: +682 54180  
Tai Cummings mobile: +682 52271

3.5.3 Request for permission for approval to land at Rarotonga International airport or Aitutaki airport shall be requested at least 14 working days prior to departure. In order to avoid delays and inconvenience, flight applications should be made not less than 5 working days before a flight.

Note: Refer to Para 1.1.3 for Aitutaki requirements.

3.5.4 The following shall be supplied with flight applications:

- (a) Name, address, telephone and fax numbers and internet address (if available) of the operator
- (b) Type and registration marks of the aircraft
- (c) Name, address and business of charterer
- (d) Proposed date and place of origin of flight
- (e) Routes including dates and times of arrival and departure
- (f) Number of passengers and/or nature of freight
- (g) Purpose of flight
- (h) Aircraft take-off weight and type pressure
- (i) Refuelling details and time required
- (j) Details of third party insurance cover for flights over or within the Cook Islands

Faxed copies of:

- (a) Certificate of airworthiness
- (b) Pilot's aviation licence and validating medical certificate

3.5.5 A response should be expected between 1–7 days after the request has been received. For planning purposes, this can be expedited provided the urgency is indicated. Any changes to the proposed itinerary must be notified.

3.5.6 Prior approval for the flight must be obtained before the flight can proceed.

3.5.7 Emergency flights are exempted from the 14 day requirement in seeking approval; however, this does not preclude the aircraft operator from providing the necessary information to the above authority at the earliest opportunity.

## 4 SCHEDULED AND NON-SCHEDULED FLIGHTS

### 4.1 General

4.1.1 All passengers, mail, cargo and crew of any overseas aircraft shall be subject *mutatis mutandis* to all applicable general or special local regulations dealing with the entry, transit and departure of persons, introduction, transit or exportation of goods, quarantine and health measures, immigration, passports, visas and travel documents.

### 4.2 Documentary Requirements for Clearance of Aircraft

4.2.1 It is necessary that the aircraft documents shown in Table GEN 1.2 – 1 be submitted by airline operators for clearance on entry and departure of their aircraft to and from the Cook Islands. All documents listed in Table GEN 1.2 – 1 must follow the ICAO standard format as set forth in the relevant appendices to ICAO Annex 9 and are acceptable when furnished in English in legible handwriting. No visas are required in connection with such documents.

4.2.2 All documents are to be submitted to Customs as soon as practicable.

**Table GEN 1.2 - 1  
Aircraft Documents Required**

REQUIRED BY	GENERAL DECLARATION	PASSENGER MANIFEST	CARGO MANIFEST
<b>CUSTOMS</b>	1	1*	1
<b>AGRICULTURE /QUARANTINE</b>	1	Nil	Nil
<b>IMMIGRATION</b>	Nil	Nil	Nil

\* Arrivals only

#### Notes

4.2.3 One copy of the General Declaration is endorsed and returned by Customs, signifying clearance.

4.2.4 If no passengers are embarking (disembarking) and no articles are laden (unladen), no aircraft documents except copies of the General Declaration need be submitted to the appropriate Customs authorities.

4.2.5 For all aircraft in excess of 22,700kg, a local handling agent must be contacted to facilitate both the arrival and departure. This requirement is in line with the Airport Authority's policy on apron management.

## 4.2.6 Contact for local agents are:

- (a) Air Rarotonga Ltd  
PO Box 79  
Rarotonga  
COOK ISLANDS
- TEL +682 20845  
FAX +682 23288  
Email [checkin@airraro.co.ck](mailto:checkin@airraro.co.ck) or  
[ross.warwick@airraro.com](mailto:ross.warwick@airraro.com)
- (b) Air New Zealand Ltd  
PO Box 65  
Rarotonga  
COOK ISLANDS
- TEL +682 26300  
FAX +682 23300  
Email [marisa.newman@airnz.co.nz](mailto:marisa.newman@airnz.co.nz) or  
[fanny.utanga@airnz.co.nz](mailto:fanny.utanga@airnz.co.nz)

## 4.2.7 However, no such permission is required for flights that fall into the following category:

- (a) Overflights by civil aircraft that have the nationality of the ICAO contracting state, provided that the requirements of the ICAO convention on International Civil Aviation are complied with.
- (b) When Rarotonga International airport is nominated in an IFR flight plan as the alternate aerodrome in accordance with CAR Part 91.405 and prior notice of diversion has been received by ATC.
- (c) The Ministry of Transport and the applicable Airport Authority has been notified 10 days prior to nomination of aerodrome as an alternate.

## **5 REQUIREMENTS FOR CLEARANCE OF AIRCRAFT**

### **5.1 Arrival**

5.1.1 On opening the aircraft doors the pilot in command or their designated representatives, must present disinsection documents for any arrival disinsection. Aircraft with non-complying disinsection certificates or that have not been disinfected will be disinfected on arrival with passengers and crew on board.

5.1.2 On arrival, the pilot in command (or operator) of the aircraft must deliver to Customs an inward report accompanied by such supporting documents that may be required.

5.1.3 The aircraft may be examined for risk goods or unwanted organisms. Where pests or unwanted organisms are found on board, an inspector may direct the aircraft to be disinfected or fumigated.

5.1.4 All garbage and food trolleys removed from the aircraft must go to an MPI approved transitional facility for sorting, cleaning and waste destruction.

### **5.2 Departure**

5.2.1 Unless otherwise approved by Customs, the pilot in command of an aircraft which has as its destination a point outside of Rarotonga must depart from an approved Customs place with a certificate of clearance in the prescribed form. Before any certificate of clearance is granted, the pilot in command must deliver to customs an outward report accompanied by any required supporting documents.

## **6 MILITARY AND STATE AIRCRAFT**

### **6.1 General**

6.1.1 Foreign military and State aircraft as defined by the Convention will require diplomatic clearance from the Ministry of Foreign Affairs and Immigration. Application for permission should be made through diplomatic channels giving a minimum of 7 full working days' notice:

Ministry of Foreign Affairs and Immigration (MFAI)  
PO Box 105  
Rarotonga  
COOK ISLANDS

TEL +682 29347  
FAX +682 29465  
Email [secfa@cookislands.gov.ck](mailto:secfa@cookislands.gov.ck)

## **7 PRIVATE FLIGHTS**

### **7.1 General**

7.1.1 Refer to section 3.1.

## **8 PUBLIC HEALTH MEASURES APPLIED TO AIRCRAFT**

### **8.1 General**

8.1.1 All arriving flights will be subject to insecticide spraying.

## **GEN 1.3 ENTRY, TRANSIT AND DEPARTURE OF PASSENGERS AND CREW**

### **1 INTRODUCTION**

#### **1.1 General**

1.1.1 All passengers entering the Cook Islands are required to present an acceptable passport or certificate of identity and complete a Passenger Arrival Card (one per person).

1.1.2 The information sought on the Arrival Card is for Customs, Immigration and Quarantine purposes.

1.1.3 Exceptions to the requirement to present an arrival card are made from time to time by way of regulations. Current exemptions are for members of the armed forces arriving on board military aircraft and for the crew of those aircraft and members of the crew of any commercial aircraft who are temporarily exempt from the requirement to hold a permit.

1.1.4 Persons leaving the Cook Islands are no longer required to fill in a Departure card.

### **2 CUSTOMS REQUIREMENTS**

#### **2.1 General**

2.1.1 The following customs requirements are applicable:

- (a) baggage or articles belonging to disembarking passengers and crew are immediately released except for those selected by Customs authorities for inspection;
- (b) no Customs formalities are normally required on departure;
- (c) duty free concessions are as per customs passenger declaration form; and
- (d) detailed information on the export of currency can be obtained from:

Collector of Customs  
Customs Dept  
PO Box 120  
Rarotonga  
COOK ISLANDS

Tel                   +682 29365  
Fax                   +682 29465  
Email:               [www.mfem.gov.ck/customs](http://www.mfem.gov.ck/customs)

### **3 IMMIGRATION REQUIREMENTS**

#### **3.1 General**

3.1.1 No documents are required for passengers and crew arriving and departing on the same aircraft in transit or transferring to another flight at the same airport. These persons are not authorized to move outside the international airport transit area on special authorization from the authorities concerned.

3.1.2 Intending immigrants are referred to the:

- (a) Principal Immigration Officer  
Ministry of Foreign Affairs and Immigration  
PO Box 105  
Rarotonga  
COOK ISLANDS  
  
TEL               +682 29347  
FAX               +682 21247  
Email             [secfa@cookislands.gov.ck](mailto:secfa@cookislands.gov.ck)
- (b) The Cook Islands Consulate  
Auckland  
NEW ZEALAND  
Email             [admin@hicom.org.nz](mailto:admin@hicom.org.nz)

#### **3.2 Passports**

3.2.1 Persons entering or leaving the Cook Islands must hold a passport valid on arrival for a period of at least six months except:

- (a) aircraft crew members declared on the general declaration form;
- (b) Cook Islanders holding an official certificate of identity (limited only to Cook Islanders travelling between the Cook Islands and New Zealand).



### 3.3 Visas

3.3.1 Is an endorsement in a passport that allows the passport bearer to travel to the Cook Islands for the purpose of visiting. Visas are required except for:

- (a) Bonafide visitors who intend to leave the Cook Islands within 31 days after arrival provided they hold tickets with reserved seats and documents for onward travel;
- (b) Cook Islanders;
- (c) Permanent residents of the Cook Islands;
- (d) Any child (born in or out of lawful wedlock) of a permanent resident;
- (e) Persons who are descendants of indigenous Cook Islands Maori;
- (f) Members of the Armed forces who enter the Cook Islands, is in the Cook Islands or leaves the Cook Islands in the performance of his duties;
- (g) HM Services personnel;
- (h) Persons accredited to the Cook Islands government or to the government of New Zealand or under the authority of any other Government;
- (i) Diplomatic representatives, United Nations or South Pacific Commission representatives;
- (j) Citizens of New Zealand;
- (k) Any person for the time being entitled to Diplomatic Privileges and Immunities under Part I or Part II of Diplomatic Privileges and Immunities Act 1968 or the Consular Privileges and Immunities Act 1971 (special exemption endorsements are placed in the travel documents of these passengers to enable them to be readily identified).

3.3.2 Visas may be issued by:

- (a) Principal Immigration Officer
- (b) the Offices of the Cook Islands Consul in Auckland, New Zealand.

3.3.3 Applications for visas should be made in writing at least one month before departure and must include proof of accommodation, maintenance in the Cook Islands and return or onwards tickets.

## **4 PUBLIC HEALTH REQUIREMENTS**

### **4.1 General**

4.1.1 Disembarking passengers are not required to present vaccination certificates except when coming directly from an area infected with cholera, plague, typhoid or recurrent fever, and includes the following countries:

- (a) Bangladesh
- (b) India
- (c) Myanmar (Burma)
- (d) Philippines
- (e) Thailand
- (f) Vietnam

4.1.2 A yellow fever vaccination certificate is required from travellers after leaving or transiting infected areas within the last 6 days.

4.1.3 If a person identified with a notifiable disease has travelled on an aircraft within the period of communicability, the public health officer may need to identify and trace passengers and crew members to prevent ongoing transmission and quarantine provisions may be necessary.

4.1.4 All foreign aircraft are subject to health quarantine.

4.1.5 On departure, no health formalities are required.

### **4.2 Responsibilities of Pilot In Command**

4.2.1 The pilot in command of an aircraft arriving into Rarotonga must notify the airline agent at least 15 minutes before landing, if:

- (a) ill persons are on board suffering from diarrhea, vomiting (not motion sickness) or abnormal temperature and a skin rash; or
- (b) there is any other condition that may lead to the spread of disease.

## **GEN 1.4 ENTRY, TRANSIT AND DEPARTURE OF CARGO**

### **1 CUSTOMS REQUIREMENTS CONCERNING CARGO AND OTHER ARTICLES**

#### **1.1 General**

1.1.1 The following Customs requirements are applicable:

- (a) outwards clearance and eventually the payment of fees are required for local goods for exportation. Payments are made through the Customs Department;
- (b) no clearance documents are required with respect to goods retained on board a transit aircraft, or cargo simply being trans-shipped from one flight to another at the same airport under Customs supervision.

### **2 AGRICULTURAL QUARANTINE REQUIREMENTS**

#### **2.1 Airport Facilities**

2.1.1 The Ministry of Agriculture administers the Plant Act 1973 and the Animal Act 1975.

2.1.2 There are restrictions on importation of plant materials, live animals, meat, and meat products.

2.1.3 The Ministry of Agriculture should be contacted for advice regarding importation of the above mentioned items and any other fruit and vegetables.

- (a) The Ministry of Agriculture  
PO Box 96  
Rarotonga  
COOK ISLANDS

TEL (682) 28 711  
FAX (682) 21 881  
email [cimoa@oyster.net.ck](mailto:cimoa@oyster.net.ck)

# **Intentionally Blank**

## **GEN 1.5 AIRCRAFT INSTRUMENTS, EQUIPMENT AND FLIGHT DOCUMENTS**

### **1 COMMERCIAL AIR TRANSPORT AIRCRAFT**

#### **1.1 General**

1.1.1 Commercial air transport aircraft operating in the Cook Islands must adhere to the provisions of ICAO Annex 6 — Operation of Aircraft, Part I — *International Commercial Air Transport — Aeroplanes*, Chapter 6 (Aeroplane Instruments, Equipment and Flight Documents) and Chapter 7 (Aeroplane Communication and Navigation Equipment), and to the Cook Islands Civil Aviation Rules.

### **2 SPECIAL EQUIPMENT TO BE CARRIED**

#### **2.1 General**

2.1.1 Special operational requirements for equipment to be carried on aircraft operating in the Cook Islands may be found in CAR Part 91, subpart F.

### **3 CARRIAGE OF SURVIVAL RADIO IN COOK ISLANDS AIRSPACE**

#### **3.1 General**

3.1.1 Aircraft shall be equipped with survival radio equipment, operating on VHF in accordance with the relevant provisions of ICAO Annex 10, stowed so as to facilitate its ready use in an emergency. The equipment shall be portable, not dependent for operation upon the aircraft's power supply, and capable of being operated away from the aircraft by unskilled persons.

3.1.2 Aircraft shall also be equipped with signalling devices and survival equipment including means of sustaining life.

# **Intentionally Blank**

## **GEN 1.6 SUMMARY OF NATIONAL REGULATIONS AND INTERNATIONAL AGREEMENTS/CONVENTIONS**

### **1 NATIONAL REGULATIONS**

#### **1.1 General**

1.1.1 Following is a list of civil aviation legislation and air navigation regulations in force in the Cook Islands. It is essential that anyone engaged in air operations be acquainted with the relevant regulations. Refer to Ministry of Transport — Cook Islands for procurement details.

- (a) Civil Aviation Act 2002
- (b) Air Services Act 1984
- (c) Aviation Security Act 2008
- (d) New Zealand Civil Aviation Act 1990
- (e) New Zealand Civil Aviation Rules and Amendments
- (f) Transport Accident Investigation Commission Act 1990
- (g) Airport Authority Act 1985 and associated amendments

### **2 INTERNATIONAL AGREEMENTS/CONVENTIONS**

#### **2.1 Conventions and Protocols**

2.1.1 The following international agreements, conventions and protocols on civil aviation have been ratified or signed by the Cook Islands Government.

- (a) Chicago Convention on International Civil Aviation 1944;
- (b) Tokyo Convention on Offences and Certain Other Acts Committed on Board Aircraft 1963;
- (c) Hague Convention for the Suppression of Unlawful Seizure of Aircraft 1970;
- (d) Montreal Supplementary Protocol for the Suppression of Unlawful Acts Against the Safety of Civil Aviation 1970;
- (e) Montreal Convention for the Suppression of Unlawful Acts Against the Safety of Civil Aviation 1971;
- (f) Acceded to the convention of the WMO 1995.

## **2.2 International Agreements**

2.2.1 The following countries have Bilateral Air Service Agreements with the Cook Islands:

- (a) Fiji;
- (b) (Open Skies) 2000;
- (c) New Zealand (Open Skies ) 2001;
- (d) Tonga (Open Skies) 2001;
- (e) Samoa (Open Skies) 2001.

2.2.2 The following lists other international agreements with the Cook Islands:

- (a) contracting state of ICAO adhered to (1986)
- (b) air transport agreement with Chile (1992)



---

## **GEN 1.7 DIFFERENCES FROM ICAO STANDARDS, RECOMMENDED PRACTICES AND PROCEDURES**

### **1 ANNEX 1 — PERSONNEL LICENSING**

1.1 Nil

### **2 ANNEX 2 — RULES OF THE AIR**

2.1 Nil

### **3 ANNEX 3 — METEOROLOGY**

3.1 Nil

### **4 ANNEX 7 — AIRCRAFT NATIONALITY AND REGISTRATION MARKS**

4.1 Nil

### **5 ANNEX 8 — AIRWORTHINESS OF AIRCRAFT**

5.1 Nil

### **6 ANNEX 9 — FACILITATION**

6.1 Nil

### **7 ANNEX 10 — AERONAUTICAL TELECOMMUNICATIONS**

7.1 Nil

### **8 ANNEX 11 — AIR TRAFFIC SERVICES**

8.1 Nil

**9 ANNEX 12 — SEARCH AND RESCUE**

9.1 Nil

**10 ANNEX 13 — AIRCRAFT ACCIDENT**

10.1 Nil

**11 ANNEX 14 — AERODROMES**

11.1 Nil

**12 ANNEX 15 — AERONAUTICAL INFORMATION SERVICES**

12.1 Nil

**13 ANNEX 16 — ENVIRONMENTAL PROTECTION**

13.1 Nil

**14 ANNEX 17 — SECURITY — SAFEGUARDING INTERNATIONAL CIVIL AVIATION AGAINST ACTS OF UNLAWFUL INTERFERENCE**

14.1 Nil

**15 ANNEX 18 — THE SAFE TRANSPORT OF DANGEROUS GOODS BY AIR**

15.1 Nil

# GEN 2 TABLES AND CODES



## GEN 2.1 MEASURING SYSTEM, AIRCRAFT MARKINGS, HOLIDAYS

### 1 UNITS OF MEASUREMENT

#### 1.1 General

1.1.1 The units of measurement used in this AIP are in accordance with the International System of Units (SI) adopted as standard in ICAO Annex 5. The Annex also specifies non-SI units for permanent use and alternate units for temporary use.

1.1.2 The table of units shown in [Table GEN 2.1 - 1](#) will be used by aeronautical stations in the Cook Islands for air and ground operations.

**Table GEN 2.1 - 1**  
**Units of Measurement**

ITEM	UNITS
Distance used in navigation, position reporting etc	Nautical miles (NM) and tenths
Altitudes and heights	Feet (ft)
Speed, including wind speed	knots (kt)
Vertical speed	Feet per minute

## **2 TIME SYSTEM**

### **2.1 General**

2.1.1 Co-ordinated Universal Time (UTC) is used by air navigation services and in publications issued by the Aeronautical Information Service. Reporting of time is expressed to the nearest minute, e.g. 22:45:40 is reported as 2246.

2.1.2 Date and time is expressed as a six figure group of day, hours and minutes, e.g. 4th February 2001, 4.35pm UTC is expressed as 041635. However, in NOTAM and preflight information bulletins, a ten figure group of year, month, day, hours and minutes is used, e.g. 0102041635.

2.1.3 Local time in the Cook Islands is UTC – 10 hours.

### **2.2 Time Signals**

2.2.1 There are no stations transmitting time signals in the Cook Islands.

2.2.2 Station WWVH at Kauai, Hawaii (female voice), and WWV at Fort Collins, Colorado (male voice), transmit time pips continuously on 2.5, 5, 10, 15, and 20 MHz, with self-explanatory voice announcements every minute.

## **3 GEODETIC REFERENCE DATUM**

### **3.1 Name/Designation of Datum**

3.1.1 World Geodetic System 1984 datum (WGS 84) is used.

### **3.2 Area of Application**

3.2.1 The World Geodetic System 1984 datum (WGS 84) applies to all charts and data within the Cook Sector of the Auckland Oceanic FIR.

### **3.3 Use of an Asterisk to Identify Published Geographical Coordinates**

3.3.1 WGS 84 positions based on source data that does not meet the survey accuracies recommended in ICAO Annex 14 are annotated with an asterisk (\*).

## 4 AIRCRAFT NATIONALITY AND REGISTRATION MARKS

### 4.1 General

4.1.1 The nationality mark for aircraft registered in the Cook Islands is E5. The nationality mark is followed by a hyphen and a registration mark consisting of three letters in roman characters followed by one or more numbers, e.g. E5-FTS.

## 5 PUBLIC HOLIDAYS

### 5.1 General

5.1.1 Public holidays for the Cook Islands are as listed in [Table GEN 2.1 - 2](#).

**Table GEN 2.1 - 2**  
**Public Holidays**

EVENT	2018	2019	2020
New Year's Day	Monday 1 January	Tuesday 1 January	Wednesday 1 January
Day After New Year's Day	Tuesday 2 January	Wednesday 2 January	Thursday 2 January
Good Friday	Friday 30 March	Friday 19 April	Friday 10 April
Easter Monday	Monday 2 April	Monday 22 April	Monday 13 April
ANZAC Day	Wednesday 25 April	Thursday 25 April	Saturday 25 April
Queen's Birthday Observed	Monday 4 June	Monday 3 June	Monday 1 June
Ra O Te Ui Arika Day	Friday 6 July	Friday 5 July	Friday 4 July
Constitution Day Observed	Monday 6 August	Monday 5 August	Monday 4 August
National Gospel Day	Thursday 25 October	Friday 25 October	Saturday 25 October but observed on Monday 27 October
Christmas Day	Tuesday 25 December	Wednesday 25 December	Friday 25 December
Boxing Day	Wednesday 26 December	Thursday 26 December	Saturday 26 December but observed on Monday 28 December

**Notes**

Where these dates fall on a weekend day, a holiday will be observed on the next available weekday except for ANZAC Day.



## GEN 2.2 ABBREVIATIONS USED IN AIS PUBLICATIONS

### 1 INTRODUCTION

#### 1.1 General

1.1.1 The abbreviations used in the AIP are generally in accordance with those listed in ICAO Procedures for Air Navigation Services, ICAO Abbreviations and Codes PANS-ABC (Doc 8400).

1.1.2 Abbreviations are correct in the use of upper and/or lower case where there is an applicable international standard, such as for units of measurement (ICAO ANNEX 5). Upper case is always used in communications on the aeronautical fixed service, such as transmission on the international AFTN.

1.1.3 Abbreviations followed by a # are to be transmitted as spoken words when using radiotelephony.

#### A

<b>A</b>	Amber
<b>A/A</b>	Air-to-air
<b>AAL</b>	Above aerodrome level
<b>ABM</b>	Abeam
<b>ABN</b>	Aerodrome beacon
<b>ABT</b>	About
<b>ABV</b>	Above
<b>AC</b>	Alto cumulus
<b>ACAS</b>	Airborne collision avoidance system
<b>ACC</b>	Area control centre or area control
<b>ACCID</b>	Notification of an aircraft accident
<b>ACFT</b>	Aircraft
<b>ACK</b>	Acknowledge
<b>ACL</b>	Altimeter check location
<b>ACN</b>	Aircraft classification number
<b>ACP</b>	Acceptance ( <i>message type designator</i> )
<b>ACPT</b>	Accept or accepted
<b>ACT</b>	Active or activated or activity
<b>AD</b>	Aerodrome
<b>ADA</b>	Advisory area
<b>ADDN</b>	Addition or additional
<b>ADF</b>	Automatic direction-finding equipment
<b>ADIZ #</b>	Air defence identification zone ( <i>pronounced "AYDIZ"</i> )
<b>ADJ</b>	Adjacent
<b>ADR</b>	Advisory route
<b>ADS</b>	Automatic dependent surveillance
<b>ADSU</b>	Automatic dependent surveillance unit
<b>ADVS</b>	Advisory service
<b>ADZ</b>	Advise

<b>AES</b>	Aircraft earth station
<b>AFIL</b>	Flight plan filed in the air
<b>AFIS</b>	Aerodrome flight information service
<b>AFM</b>	Yes or affirm or affirmative or that is correct
<b>AFS</b>	Aeronautical fixed service
<b>AFT</b>	After ... ( <i>time or place</i> )
<b>AFTN</b>	Aeronautical fixed telecommunications network
<b>A/G</b>	Air to ground
<b>AGA</b>	Aerodromes, air routes and ground aids
<b>AGL</b>	Above ground level
<b>AGN</b>	Again
<b>AIC</b>	Aeronautical information circular
<b>AIP</b>	Aeronautical information publication
<b>AIRAC</b>	Aeronautical information regulation and control
<b>AIREP #</b>	Air report
<b>AIS</b>	Aeronautical information services
<b>ALA</b>	Alighting area
<b>ALERFA #</b>	Alert phase
<b>ALR</b>	Alerting ( <i>message type designator</i> )
<b>ALRS</b>	Alerting service
<b>ALS</b>	Approach lighting system
<b>ALT</b>	Altitude
<b>ALTN</b>	Alternate or alternating ( <i>light alternates in colour</i> )
<b>ALTN</b>	Alternate ( <i>aerodrome</i> )
<b>AMA</b>	Area minimum altitude
<b>AMD</b>	Amend or amended
<b>AMDT</b>	Amendment ( <i>AIP Amendment</i> )
<b>AMS</b>	Aeronautical mobile service
<b>AMSL</b>	Above mean sea level
<b>AMSS</b>	Aeronautical mobile satellite service
<b>ANS</b>	Answer
<b>AOC</b>	Aerodrome obstacle chart
<b>AP</b>	Airport
<b>APCH</b>	Approach
<b>APP</b>	Approach control office or Approach control or Approach control service
<b>APR</b>	April
<b>APRX</b>	Approximate or approximately
<b>APSG</b>	After passing
<b>APV</b>	Approve or approved or approval
<b>AREA #</b>	Area chart
<b>ARFOR</b>	Area forecast
<b>ARNG</b>	Arrange
<b>ARO</b>	Air traffic services reporting office
<b>ARP</b>	Aerodrome reference point

<b>ARP</b>	Air-report ( <i>message type designator</i> )
<b>ARR</b>	Arrive or arrival
<b>ARS</b>	Special air-report ( <i>message type designator</i> )
<b>ARST</b>	Arresting [ <i>specify (part of) aircraft arresting equipment</i> ]
<b>AS</b>	Altostratus
<b>ASC</b>	Ascend to or Ascending to
<b>ASDA</b>	Accelerate-stop distance available
<b>ASPH</b>	Asphalt
<b>AT ...</b>	At ( <i>followed by time at which weather change is forecast to occur</i> )
<b>ATA</b>	Actual time of arrival
<b>ATC</b>	Air traffic control ( <i>in general</i> )
<b>ATD</b>	Actual time of departure or Along Track Distance
<b>ATFM</b>	Air traffic flow management
<b>ATIS #</b>	Automatic terminal information service
<b>ATM</b>	Air traffic management
<b>ATN</b>	Aeronautical telecommunication network
<b>ATP</b>	At ... ( <i>time or place</i> )
<b>ATS</b>	Air traffic services
<b>ATTN</b>	Attention
<b>ATZ</b>	Aerodrome traffic zone
<b>AUG</b>	August
<b>AUTH</b>	Authorised or Authorisation
<b>AUW</b>	All up weight
<b>AUX</b>	Auxiliary
<b>AVASIS</b>	Abbreviated visual approach slope indicator system
<b>AVBL</b>	Available or Availability
<b>AVG</b>	Average
<b>AVGAS #</b>	Aviation gasoline
<b>AWS</b>	Automatic weather station
<b>AWTA</b>	Advise at what time able
<b>AWY</b>	Airway
<b>AZM</b>	Azimuth

**B**

<b>B</b>	Blue
<b>BA</b>	Braking action
<b>BASE #</b>	Cloud base
<b>BCFG</b>	Fog patches
<b>BCN</b>	Beacon ( <i>Aeronautical ground light</i> )
<b>BCST</b>	Broadcast
<b>BDRY</b>	Boundary
<b>BECMG</b>	Becoming
<b>BFR</b>	Before
<b>BKN</b>	Broken
<b>BL ...</b>	Blowing ( <i>followed by DU=dust, SA=sand or SN=snow</i> )
<b>BLDG</b>	Building
<b>BLO</b>	Below clouds
<b>BLW</b>	Below ...
<b>BOMB</b>	Bombing
<b>BR</b>	Mist
<b>BRF</b>	Short ( <i>used to indicate the type of approach desired or required</i> )
<b>BRG</b>	Bearing
<b>BRKG</b>	Braking
<b>BS</b>	Commercial broadcasting station
<b>BTL</b>	Between layers
<b>BTN</b>	Between
<b>BWR</b>	Basic Weather Report

**C**

<b>C</b>	Degrees Celsius ( <i>Centigrade</i> )
<b>CASO #</b>	Civil Aviation Safety Order ( <i>pronounced "KAYSO"</i> )
<b>CAT</b>	Category
<b>CAT</b>	Clear air turbulence
<b>CAVOK #</b>	Visibility, cloud and present weather better than prescribed values or conditions ( <i>pronounced "CAVOKAY"</i> )
<b>CB #</b>	Cumulonimbus ( <i>pronounced "SEEBEE"</i> )
<b>CC</b>	Cirrocumulus
<b>Cd</b>	Candela(s)
<b>CDN</b>	Co-ordination ( <i>message type designator</i> )
<b>CF</b>	Change frequency to or Course Fix (used with GPS approaches — often equivalent to IF)
<b>CGL</b>	Circling guidance light(s)
<b>CH</b>	Channel
<b>CHG</b>	Modification ( <i>message type designator</i> )
<b>CI</b>	Cirrus
<b>CIT</b>	Near or over large town(s)
<b>CIV</b>	Civil
<b>CK</b>	Check
<b>CL</b>	Centreline
<b>CLA</b>	Clear type of ice formation
<b>CLBR</b>	Calibration
<b>CLD</b>	Cloud
<b>CLG</b>	Calling
<b>CLR</b>	Cleared or Cleared to ... or Clearance
<b>CLSD</b>	Close or Closed or Closing
<b>CM</b>	Centimetre
<b>CMB</b>	Climb to or Climbing to
<b>CMPL</b>	Completion or Completed or Complete
<b>CNL</b>	Cancel or Cancelled
<b>CNS</b>	Communications, navigation and surveillance
<b>CONS</b>	Continuous
<b>COM</b>	Communications
<b>CONC</b>	Concrete
<b>COND</b>	Condition(s)

<b>CONST</b>	Construction or Constructed
<b>CONT</b>	Continue or Continued
<b>COOR</b>	Co-ordinate or Co-ordination
<b>COP</b>	Change-over point
<b>COR</b>	Correct or Corrected or Correction
<b>COT</b>	At the coast
<b>COV</b>	Cover or Covered or Covering
<b>CPL</b>	Current flight plan ( <i>message type designator</i> )
<b>CRZ</b>	Cruise
<b>CS</b>	Cirrostratus
<b>CTA</b>	Control area
<b>CTAM</b>	Climb to and maintain
<b>CTC</b>	Contact
<b>CTL</b>	Control
<b>CTN</b>	Caution
<b>CTR</b>	Control zone
<b>CU</b>	Cumulus
<b>CUF</b>	Cumuloform
<b>CUST</b>	Customs
<b>CW</b>	Continuous wave
<b>CWY</b>	Clearway

**D**

<b>d</b>	Day
<b>D ...</b>	Danger area <i>(followed by identification)</i>
<b>DA</b>	Decision altitude
<b>DCKG</b>	Docking
<b>DCT</b>	Direct <i>(in relation to flight plan clearances and type of approach)</i>
<b>DEC</b>	December
<b>DEG</b>	Degrees
<b>DENEB</b>	Fog dispersal operations
<b>DEP</b>	Depart or Departure
<b>DES</b>	Descend to or Descending to
<b>DEST</b>	Destination
<b>DETRESFA #</b>	Distress phase
<b>DEV</b>	Deviation or Deviating
<b>DFTI</b>	Distance from touchdown indicator
<b>DH</b>	Decision height
<b>DIF</b>	Diffuse
<b>DIST</b>	Distance
<b>DIV</b>	Divert or Diverting or Diversion
<b>DLA</b>	Delay or Delayed
<b>DME</b>	Distance measuring equipment
<b>DNG</b>	Danger or Dangerous
<b>DOM</b>	Domestic
<b>DP</b>	Dewpoint temperature
<b>DPT</b>	Depth
<b>DR ...</b>	Low drifting <i>(followed by DU=dust, SA=sand or SN=snow)</i>
<b>DR</b>	Dead reckoning
<b>DRG</b>	During
<b>DS</b>	Duststorm
<b>DTAM</b>	Descend to and maintain
<b>DTG</b>	Date-time group
<b>DTRT</b>	Deteriorate or Deteriorating
<b>DTW</b>	Dual tandem wheels
<b>DU</b>	Dust
<b>DUC</b>	Dense upper cloud
<b>DUR</b>	Duration
<b>DVOR</b>	Doppler VOR
<b>DW</b>	Dual wheels
<b>DZ</b>	Drizzle

**E**

<b>E</b>	East or Eastern longitude
<b>EAT</b>	Expected approach time
<b>EB</b>	Eastbound
<b>EET</b>	Estimated elapsed time
<b>EFC</b>	Expect further clearance
<b>ELTA #</b>	Emergency locator beacon — aircraft
<b>ELEV</b>	Elevation
<b>ELR</b>	Extra long range
<b>ELT</b>	Emergency locator transmitter
<b>EM</b>	Emission
<b>EMBD</b>	Embedded in a layer ( <i>to indicate cumulonimbus embedded in layers of other clouds</i> )
<b>EMERG</b>	Emergency
<b>END</b>	Stop-end ( <i>related to RVR</i> )
<b>ENE</b>	East north-east
<b>ENG</b>	Engine
<b>ENRT</b>	En-route
<b>EOBT</b>	Estimated off-blocks time
<b>EQPT</b>	Equipment
<b>ER</b>	Here ... or Herewith
<b>ERC #</b>	En-route chart
<b>ESE</b>	East-south-east
<b>EST</b>	Estimate or Estimated
<b>ETA</b>	Estimated time of arrival
<b>ETD</b>	Estimated time of departure
<b>ETO</b>	Estimated time over a significant point
<b>EV</b>	Every
<b>EXC</b>	Except
<b>EXER</b>	Exercises or Exercising or to Exercise
<b>EXP</b>	Expect or Expected or Expecting
<b>EXTD</b>	Extend or Extending



**F**

<b>F</b>	Fixed
<b>FAC</b>	Facilities
<b>FAF</b>	Final approach fix
<b>FAL</b>	Facilitation of international air transport
<b>FAP</b>	Final approach point
<b>FATO</b>	Final approach and take-off area
<b>FAX</b>	Facsimile transmission
<b>FBL</b>	Light ( <i>used to indicate the intensity of weather phenomena, interference or static reports, e.g. FBL RA=light rain</i> ).
<b>FC</b>	Funnel cloud
<b>FCST</b>	Forecast
<b>FCT</b>	Friction coefficient
<b>FEB</b>	February
<b>FG</b>	Fog
<b>FIC</b>	Flight information centre
<b>FIR</b>	Flight information region
<b>FIS</b>	Flight information service
<b>FISA</b>	Automated flight information service
<b>FL</b>	Flight level
<b>FLD</b>	Field
<b>FLG</b>	Flashing
<b>FLR</b>	Flares
<b>FLT</b>	Flight
<b>FLTCK</b>	Flight check
<b>FLUC</b>	Fluctuating or Fluctuation or Fluctuated
<b>FLW</b>	Follow(s) or Following
<b>FLY</b>	Fly or Flying
<b>FM ...</b>	From ( <i>followed by time weather change is forecast to begin</i> )
<b>FM</b>	From
<b>FMU</b>	Flow management unit
<b>FNA</b>	Final approach
<b>FPL</b>	Filed flight plan ( <i>message type designator</i> )
<b>FPM</b>	Feet per minute
<b>FPR</b>	Flight plan route
<b>FR</b>	Fuel remaining
<b>FREQ</b>	Frequency
<b>FRI</b>	Friday
<b>FRNG</b>	Firing
<b>FRONT #</b>	Front ( <i>relating to weather</i> )
<b>FRQ</b>	Frequent
<b>FSL</b>	Full stop landing
<b>FSS</b>	Flight service station
<b>FST</b>	First
<b>ft</b>	Foot or Feet ( <i>dimensional unit</i> )
<b>FU</b>	Smoke
<b>FZ</b>	Freezing drizzle
<b>FZFG</b>	Freezing fog
<b>FZRA</b>	Freezing rain

**G**

<b>G</b>	Green
<b>G/A</b>	Ground-to-air
<b>G/A/G</b>	Ground-to-air and air-to-ground
<b>GCA</b>	Ground controlled approach system or Ground controlled approach
<b>GEN</b>	General
<b>GEO</b>	Geographic or true
<b>GES</b>	Ground earth station
<b>GLD</b>	Glider
<b>GND</b>	Ground
<b>GNDCK</b>	Ground check
<b>GNSS</b>	Global navigation satellite system
<b>GP</b>	Glide path
<b>GPS</b>	Global Positioning System
<b>GR</b>	Hail or soft hail
<b>GRASS</b>	Grass landing area
<b>GRID</b>	Processed meteorological data in the form of grid values <i>(in aeronautical meteorological code)</i>
<b>GRVL</b>	Gravel
<b>GS</b>	Small hail and/or snow pellets
<b>GS</b>	Ground speed

**H**

<b>H24</b>	Continuous day and night service
<b>HAPI</b>	Helicopter approach path indicator
<b>HBN</b>	Hazard beacon
<b>HDF</b>	High frequency direction-finding station
<b>HDG</b>	Heading
<b>HEL</b>	Helicopter
<b>HF</b>	High frequency ( <i>3,000 to 30,000 kHz</i> )
<b>HGT</b>	Height or Height above
<b>HJ</b>	Sunrise to sunset
<b>HLDG</b>	Holding
<b>HN</b>	Sunset to sunrise
<b>HO</b>	Service available to meet operational requirements
<b>HOL</b>	Holiday
<b>HOSP</b>	Hospital aircraft
<b>hPa</b>	Hectopascal
<b>HR</b>	Hours
<b>HS</b>	Service available during hours of scheduled operations
<b>HURCN</b>	Hurricane
<b>HVY</b>	Heavy
<b>HVY</b>	Heavy ( <i>used to indicate the intensity of weather phenomena, e.g. HVY RA=heavy rain</i> )
<b>HX</b>	No specific working hours
<b>HYR</b>	Higher
<b>HZ</b>	Dust haze
<b>Hz</b>	Hertz ( <i>cycles per second</i> )

**I**

<b>IAC</b>	Instrument approach chart
<b>IAF</b>	Initial approach fix
<b>IAO</b>	In and out of clouds
<b>IAR</b>	InterSection of air routes
<b>IAS</b>	Indicated air speed
<b>IBN</b>	Identification beacon
<b>IC</b>	Diamond dust ( <i>very small ice crystals in suspension</i> )
<b>ICAO</b>	International Civil Aviation Organisation
<b>ICE</b>	Icing
<b>ID</b>	Identifier or Identify
<b>IDENT #</b>	Identification
<b>IF</b>	Intermediate approach fix
<b>IFF</b>	Identification friend/foe
<b>IFR</b>	Instrument flight rules
<b>IGA</b>	International general aviation
<b>ILS</b>	Instrument landing system
<b>IM</b>	Inner marker
<b>IMC</b>	Instrument meteorological conditions
<b>IMG</b>	Immigration
<b>IMPR</b>	Improve or improving
<b>IMT</b>	Immediate or Immediately
<b>INA</b>	Initial approach
<b>INBD</b>	Inbound
<b>INC</b>	In cloud
<b>INCERFA #</b>	Uncertainty phase
<b>INFO #</b>	Information
<b>INOP</b>	Inoperative
<b>INP</b>	If not possible
<b>INPR</b>	In progress
<b>INS</b>	Inertial navigation system
<b>INSTL</b>	Install or Installed or Installation
<b>INSTR</b>	Instrument
<b>INT</b>	InterSection
<b>INTL</b>	International
<b>INTRG</b>	Interrogator
<b>INTRP</b>	Interrupt or Interruption or Interrupted
<b>INTSF</b>	Intensify or Intensifying
<b>INTST</b>	Intensity
<b>IR</b>	Ice on runway
<b>ISA</b>	International standard atmosphere
<b>ISOL</b>	Isolated

**J**

<b>JAN</b>	January
<b>JTST</b>	Jetstream
<b>JUL</b>	July
<b>JUN</b>	June

**K**

<b>kg</b>	Kilogram/s
<b>kHz</b>	Kilohertz
<b>km</b>	Kilometre/s
<b>km/h</b>	Kilometres per hour
<b>kPa</b>	Kilopascal/s
<b>kt</b>	Knot
<b>kW</b>	Kilowatt/s

**L**

<b>L</b>	Left ( <i>runway identification</i> )
<b>L</b>	Locator ( <i>see LM, LO</i> )
<b>LAN</b>	Inland
<b>LAT</b>	Latitude
<b>LCA</b>	Local or Locally or Location or Located
<b>LDA</b>	Landing distance available
<b>LDAH</b>	Landing distance available, helicopter
<b>LDG</b>	Landing
<b>LDI</b>	Landing direction indicator
<b>LEN</b>	Length
<b>LF</b>	Low frequency ( <i>30 to 300 kHz</i> )
<b>LGT</b>	Light or Lighting
<b>LGTD</b>	Lighted
<b>LIH</b>	Light intensity high
<b>LIL</b>	Light intensity low
<b>LIM</b>	Light intensity medium
<b>LM</b>	Locator, middle
<b>LMT</b>	Local mean time
<b>LNG</b>	Long ( <i>used to indicate the type of approach desired or required</i> )
<b>LO</b>	Locator, outer
<b>LOC</b>	Localiser
<b>LONG</b>	Longitude

<b>LORAN #</b>	Long range air navigation system
<b>LRG</b>	Long range
<b>LSQ</b>	Line squall
<b>LTD</b>	Limited
<b>LV</b>	Light and variable ( <i>wind</i> )
<b>LVE</b>	Leave or Leaving
<b>LVL</b>	Level
<b>LYR</b>	Layer or Layered
<b>M</b>	
<b>M</b>	Mach number ( <i>followed by figures</i> )
<b>m</b>	Metres ( <i>preceded by figures</i> )
<b>MAA</b>	Maximum authorised altitude
<b>MAG</b>	Magnetic ( <i>preceded by figures</i> )
<b>MAINT</b>	Maintenance
<b>MAP</b>	Aeronautical maps and charts
<b>MAPt</b>	Missed approach point
<b>MAR</b>	March
<b>MAR</b>	At sea
<b>MAX</b>	Maximum
<b>MAY</b>	May
<b>MCA</b>	Minimum crossing altitude
<b>MCW</b>	Modulated continuous wave
<b>MDA</b>	Minimum descent altitude
<b>MDF</b>	Medium frequency direction-finding station
<b>MDH</b>	Minimum descent height
<b>MEA</b>	Minimum en-route altitude
<b>MEHT</b>	Minimum eye height over threshold ( <i>for visual approach slope indicator systems</i> )
<b>MET #</b>	Meteorological or Meteorology
<b>METAR #</b>	Aviation routine weather report ( <i>in aeronautical meteorological code</i> )
<b>MF</b>	Medium frequency ( <i>300 to 3,000 kHz</i> )
<b>MHz</b>	Megahertz
<b>MID</b>	Mid-point ( <i>related to RVR</i> )
<b>MIFG</b>	Shallow fog
<b>MIL</b>	Military
<b>min</b>	Minute/s
<b>MKR</b>	Marker radio beacon
<b>MLS</b>	Microwave landing system
<b>MM</b>	Middle marker
<b>MNM</b>	Minimum
<b>MNPS</b>	Minimum navigation performance specifications
<b>MNT</b>	Monitor or Monitoring or Monitored

<b>MNTN</b>	maintain
<b>MOA</b>	Military operating area
<b>MOC</b>	Minimum obstacle clearance ( <i>required</i> )
<b>MOD</b>	Moderate ( <i>used to indicate the intensity of weather phenomena, interference or static reports, e.g. MOD RA=moderate rain.</i> )
<b>MON</b>	Above mountains
<b>MON</b>	Monday
<b>MOV</b>	Move or Moving or Movement
<b>MPS</b>	Metres per second
<b>MRA</b>	Minimum reception altitudes ( <i>VHF/UHF</i> )
<b>MRG</b>	Medium range
<b>MRP</b>	ATS/MET reporting point
<b>MS</b>	Minus
<b>MSA</b>	Minimum safe altitude
<b>MSG</b>	Message
<b>MSL</b>	Mean sea level
<b>MT</b>	Mount or Mountain
<b>MTU</b>	Metric units
<b>MTW</b>	Mountain waves
<b>MWO</b>	Meteorological watch office
<b>MX</b>	Mixed type of ice formation ( <i>white and clear</i> )

**N**

<b>N</b>	No distinct tendency ( <i>in RVR during previous 10 minutes</i> )
<b>N</b>	North or
	Northern latitude
<b>NAV</b>	Navigation
<b>NB</b>	Northbound
<b>NBFR</b>	Not before
<b>NC</b>	No change
<b>NDB</b>	Non-directional radio beacon
<b>NE</b>	North-east
<b>NEB</b>	North-eastbound
<b>NEG</b>	No or
	Negative or
	Permission not granted or
	That is not correct
<b>NGT</b>	Night
<b>NIL #</b>	None or
	I have nothing to send you
<b>NM</b>	Nautical miles
<b>NML</b>	Normal
<b>NNE</b>	North north-east
<b>NNW</b>	North north-west
<b>NOF</b>	International NOTAM office
<b>NORDO #</b>	Non-radio equipped
<b>NOSIG #</b>	No significant change ( <i>used in trend-type landing forecasts</i> )
<b>NOTAM #</b>	A notice containing information concerning the establishment, condition or change in any aeronautical facility, service, procedure or hazard, the timely knowledge of which is essential to personnel concerned with flight operations
<b>NOV</b>	November
<b>NR</b>	Number
<b>NRH</b>	No reply heard
<b>NS</b>	Nimbostratus
<b>NSC</b>	Nil significant cloud
<b>NSW</b>	Nil significant weather
<b>NW</b>	North-west
<b>NWB</b>	North-westbound
<b>NXT</b>	Next



**O**

<b>OAC</b>	Oceanic area control centre
<b>OAS</b>	Obstacle assessment surface
<b>OBS</b>	Observe or Observed or Observation
<b>OBSC</b>	Obscure or Obscured or Obscuring
<b>OBST</b>	Obstacle
<b>OCA</b>	Obstacle clearance altitude
<b>OCA</b>	Oceanic control area
<b>OCC</b>	Occulting ( <i>light</i> )
<b>OCH</b>	Obstacle clearance height
<b>OCNL</b>	Occasional or Occasionally
<b>OCS</b>	Obstacle clearance surface
<b>OCT</b>	October
<b>OHD</b>	Overhead
<b>OKTA #</b>	Eighths of sky cover
<b>OM</b>	Outer marker
<b>OMNI #</b>	Omnidirectional
<b>OPA</b>	Opaque, white type of ice formation
<b>OPC</b>	The control indicated is operational control
<b>OPMET #</b>	Operational meteorological ( <i>information</i> )
<b>OPN</b>	Open or Opening or Opened
<b>OPR</b>	Operator or Operate or Operative or Operating or Operational
<b>OPS #</b>	Operations
<b>O/R</b>	On request
<b>ORD</b>	Indication of an order
<b>OSV</b>	Ocean station vehicle
<b>OTLK</b>	Outlook ( <i>used in SIGMET messages for volcanic ash and tropical cyclones</i> )
<b>OTP</b>	On top
<b>OTS</b>	Organised track system
<b>OUBD</b>	Outbound
<b>OVC</b>	Overcast

**P**

<b>P..</b>	Prohibited area ( <i>followed by identification</i> )
<b>PAL #</b>	Pilot activated lighting
<b>PALS</b>	Precision approach lighting system ( <i>specify category</i> )
<b>PANS #</b>	Procedures for air navigation services
<b>PAPI #</b>	Precision approach path indicator
<b>PAR</b>	Precision approach radar
<b>PARL</b>	Parallel
<b>PAX</b>	Passenger(s)
<b>PCD</b>	Proceed or Proceeding
<b>PCN</b>	Pavement classification number
<b>PE</b>	Ice pellets
<b>PER</b>	Performance
<b>PERM</b>	Permanent
<b>PIREP #</b>	Pilot's report
<b>PJE</b>	Parachute jumping exercise
<b>PLA</b>	Practice low approach
<b>PLN</b>	Flight plan
<b>PLVL</b>	Present level
<b>PN</b>	Prior notice required
<b>PNR</b>	Point of no return
<b>PO</b>	Dust devils
<b>POB</b>	Persons on board
<b>POSS</b>	Possible
<b>PPI</b>	Plan position indicator
<b>PPR</b>	Prior permission required
<b>PPSN</b>	Present position
<b>PRI</b>	Primary
<b>PRKG</b>	Parking
<b>PROB #</b>	Probability
<b>PROC</b>	Procedure
<b>PROV</b>	Provisional
<b>PS</b>	Plus
<b>PSG</b>	Passing
<b>PSN</b>	Position
<b>PTN</b>	Procedure turn
<b>PTS</b>	Polar track structure
<b>PWR</b>	Power

**Q**

<b>QBI</b>	Compulsory IFR flight
<b>QDM</b>	Magnetic heading ( <i>zero wind</i> )
<b>QDR</b>	Magnetic heading
<b>QFE</b>	Atmospheric pressure at aerodrome level ( <i>or at runway threshold</i> )
<b>QFU</b>	Magnetic orientation of runway
<b>QNH</b>	An altimeter sub-scale setting to obtain elevation when on the ground
<b>QTE</b>	True bearing
<b>QUAD</b>	Quadrant

**R**

<b>R</b>	Red
<b>R</b>	Right ( <i>runway identification</i> )
<b>R...</b>	Restricted area ( <i>followed by identification</i> )
<b>RA</b>	Rain
<b>RAC</b>	Rules of the air and air traffic services
<b>RAFC</b>	Regional area forecast centre
<b>RAG</b>	Runway arresting gear
<b>RAG</b>	Ragged
<b>RAI</b>	Runway alignment indicator
<b>RB</b>	Rescue boat
<b>RCA</b>	Reach cruising altitude
<b>RCC</b>	Rescue co-ordination centre
<b>RCF</b>	Radiocommunication failure ( <i>message type designator</i> )
<b>RCH</b>	Reach or Reaching
<b>RCL</b>	Runway centreline
<b>RCLL</b>	Runway centre line light(s)
<b>RCLR</b>	Recleared
<b>RDH</b>	Reference datum height ( <i>for ILS</i> )
<b>RDL</b>	Radial
<b>RDO</b>	Radio
<b>RE ...</b>	Recent ( <i>used to qualify weather phenomena, e.g. RERA=recent rain</i> )
<b>REC</b>	Receive or Receiver
<b>REDL</b>	Runway edge light(s)
<b>REF</b>	Reference to...or Refer to....
<b>REG</b>	Registration
<b>RENL</b>	Runway end light(s)
<b>REP</b>	Report or Reporting or Reporting point

<b>REQ</b>	Request or Requested
<b>ERTE</b>	Re-route
<b>RG</b>	Range ( <i>lights</i> )
<b>RIF</b>	Re-clearance in flight
<b>RITE</b>	Right ( <i>direction of turn</i> )
<b>RL</b>	Reporting leaving
<b>RLA</b>	Relay to
<b>RLCE</b>	Request level change en route
<b>RLLS</b>	Runway lead-in lighting system
<b>RLNA</b>	Request level not available
<b>RMK</b>	Remark(s)
<b>RNAV #</b>	Area navigation ( <i>pronounced "ARNAV"</i> )
<b>RNG</b>	Radio range
<b>RNP</b>	Required navigation performance
<b>ROBEX</b>	Routine OPMET Bulletin exchange ( <i>scheme</i> )
<b>ROC</b>	Rate of climb
<b>ROD</b>	Rate of descent
<b>ROFOR</b>	Route forecast
<b>RON</b>	Receiving only
<b>RPL</b>	Repetitive flight plan
<b>RPLC</b>	Replace or Replaced
<b>RPS</b>	Radar position symbol
<b>RQMNTS</b>	Requirements
<b>RQP</b>	Request flight plan ( <i>message type designator</i> )
<b>RQS</b>	Request supplementary flight plan ( <i>message type designator</i> )
<b>RR</b>	Report reaching
<b>RSC</b>	Rescue sub-centre
<b>RSCD</b>	Runway surface condition
<b>RSP</b>	Responder beacon
<b>RSR</b>	En-route surveillance radar
<b>RTE</b>	Route
<b>RTF</b>	Radio telephone
<b>RTG</b>	Radiotelegraph
<b>RTHL</b>	Runway threshold lights
<b>RTN</b>	Return or Returned or Returning
<b>RTODAH</b>	Rejected take-off distance available, helicopter
<b>RTS</b>	Return to service
<b>RTT</b>	Radio teletypewriter ( <i>military</i> )
<b>RTZL</b>	Runway touchdown zone light(s)
<b>RUT</b>	Standard regional route transmitting frequencies
<b>RV</b>	Rescue vessel
<b>RVR</b>	Runway visual range
<b>RWY</b>	Runway

**S**

<b>s</b>	Second(s)
<b>S</b>	South or Southern latitude
<b>SA</b>	Sand
<b>SALS</b>	Simple approach lighting system
<b>SAN</b>	Sanitary
<b>SAP</b>	As soon as possible
<b>SAR</b>	Search and rescue
<b>SARPS</b>	Standards and recommended practices ( <i>ICAO</i> )
<b>SAT</b>	Saturday
<b>SB</b>	Southbound
<b>SC</b>	Stratocumulus
<b>SCT</b>	Scattered
<b>SDBY</b>	Standby
<b>SE</b>	South-east
<b>SEB</b>	South-eastbound
<b>SEC</b>	Seconds
<b>SECT</b>	Sector
<b>SELCAL #</b>	Selective calling system
<b>SEP</b>	September
<b>SER</b>	Service or Servicing or Served
<b>SEV</b>	Severe ( <i>used to qualify icing and turbulence reports</i> )
<b>SFC</b>	Surface
<b>SG</b>	Snow grains
<b>SGL</b>	Signal
<b>SH</b>	Showers ( <i>followed by RA=rain, SN=snow, PE=ice pellets, GR=hail, GS=small hail and/or ice pellets or combinations thereof, e.g. SHRASN=showers of rain and snow</i> )
<b>SHF</b>	Super high frequency ( <i>3000 to 30 000 MHz</i> )
<b>SID #</b>	Standard instrument departure
<b>SIF</b>	Selective identification feature
<b>SIGMET #</b>	Information concerning en-route weather phenomena which may affect the safety of aircraft operations
<b>SIGWX</b>	Significant weather
<b>SIMUL</b>	Simultaneous or Simultaneously
<b>SIWL</b>	Single isolated wheel load
<b>SKC</b>	Sky clear
<b>SKED</b>	Schedule or Scheduled
<b>SLP</b>	Speed limiting point
<b>SLW</b>	Slow
<b>SMC</b>	Surface movement control
<b>SMR</b>	Surface movement radar
<b>SN</b>	Snow

<b>SPARS #</b>	Special aerodrome reports
<b>SPECI #</b>	Aviation selected special weather report ( <i>aeronautical meteorological code</i> )
<b>SPECIAL #</b>	Special meteorological report ( <i>in abbreviated plain language</i> )
<b>SPL</b>	Supplementary flight plan ( <i>message type designator</i> )
<b>SPOT #</b>	Spot wind
<b>SQ</b>	Squall
<b>SQL</b>	Squall line
<b>SR</b>	Sunrise
<b>SRA</b>	Surveillance radar approach
<b>SRE</b>	Surveillance radar element of a precision approach radar system
<b>SRG</b>	Short range
<b>SRR</b>	Search and rescue region
<b>SRY</b>	Secondary
<b>SS</b>	Sandstorm
<b>SS</b>	Sunset
<b>SSB</b>	Single sideband
<b>SSE</b>	South south-east
<b>SSR</b>	Secondary surveillance radar
<b>SST</b>	Supersonic transport
<b>SSW</b>	South south-west
<b>ST</b>	Stratus
<b>STA</b>	Straight-in approach
<b>STAR #</b>	Standard instrument arrival
<b>STD</b>	Standard
<b>STF</b>	Stratiform
<b>STN</b>	Station
<b>STNR</b>	Stationary
<b>STOL</b>	Short take-off and landing
<b>STS</b>	Status
<b>STWL</b>	Stopway lights
<b>SUBJ</b>	Subject to
<b>SUN</b>	Sunday
<b>SUP</b>	Supplement ( <i>AIP Supplement</i> )
<b>SUPPS</b>	Regional supplementary procedures
<b>SVC</b>	Service message
<b>SVCBL</b>	Serviceable
<b>SW</b>	South-west
<b>SWB</b>	South-westbound
<b>SWY</b>	Stopway

**T**

<b>T</b>	Temperature
<b>TA</b>	Transition altitude
<b>TACAN #</b>	UHF tactical air navigation aid
<b>TAF #</b>	Aerodrome forecast
<b>TAIL #</b>	Tailwind
<b>TAR</b>	Terminal area surveillance radar
<b>TAS</b>	True air speed
<b>TAX</b>	Taxiing or Taxi
<b>TC</b>	Tropical cyclone
<b>TCU</b>	Towering cumulus
<b>TDO</b>	Tornado
<b>TDZ</b>	Touchdown zone
<b>TECR</b>	Technical reason
<b>TEL</b>	Telephone
<b>TEMPO</b>	Temporary or Temporarily
<b>TEND</b>	Trend forecast
<b>TFC</b>	Traffic
<b>TGL</b>	Touch-and-go landing
<b>TGS</b>	Taxiing guidance system
<b>THR</b>	Threshold
<b>THRU</b>	Through
<b>THU</b>	Thursday
<b>TIL #</b>	Until
<b>TIP</b>	Until past ... ( <i>place</i> )
<b>TKOF</b>	Take-off
<b>TL ...</b>	Till ( <i>followed by the time by which weather change is forecast to end</i> )
<b>TLOF</b>	Touchdown and lift-off area
<b>TMA</b>	Terminal control area
<b>TNA</b>	Turn altitude
<b>TNH</b>	Turn height
<b>TO</b>	To... ( <i>place</i> )
<b>TOC</b>	Top of climb
<b>TODA</b>	Take-off distance available
<b>TODAH</b>	Take-off distance available, helicopter
<b>TOP #</b>	Cloud top
<b>TORA</b>	Take-off run available
<b>TP</b>	Turning point
<b>TR</b>	Track
<b>TRA</b>	Temporary reserved airspace
<b>TRANS</b>	Transmits or Transmitter
<b>TRL</b>	Transition level
<b>TROP</b>	Tropopause

<b>TS</b>	Thunderstorm ( <i>in aerodrome reports and forecasts, TS used alone means thunder heard but no precipitation at the aerodrome</i> )
<b>TS ...</b>	Thunderstorm ( <i>followed by RA=rain, SN=snow, PE=ice pellets, GR=hail, GS=small hail and/or snow pellets or combinations thereof, e.g. TSRASN=thunderstorm with rain and snow</i> )
<b>TT</b>	Teletypewriter
<b>TUE</b>	Tuesday
<b>TURB</b>	Turbulence
<b>T-VASIS #</b>	"T" visual approach slope indicator system
<b>TVOR</b>	Terminal VOR
<b>TWR</b>	Aerodrome control tower or Aerodrome control
<b>TWY</b>	Taxiway
<b>TWYL</b>	Taxiway-link
<b>TYP</b>	Type of aircraft
<b>TYPH</b>	Typhoon

**U**

<b>U</b>	Upward ( <i>tendency in RVR during previous 10 minutes</i> )
<b>UAB</b>	Until advised by ...
<b>UAC</b>	Upper area control centre
<b>UAR</b>	Upper air route
<b>UDF</b>	Ultra high frequency direction-finding station
<b>UFN</b>	Until further notice
<b>UHDT</b>	Unable higher due traffic
<b>UHF</b>	Ultra high frequency ( <i>300 to 3,000 MHz</i> )
<b>UIC</b>	Upper information centre
<b>UIR</b>	Upper flight information region
<b>ULR</b>	Ultra long range
<b>UNA</b>	Unable
<b>UNAP</b>	Unable to approve
<b>UNL</b>	Unlimited
<b>UNREL</b>	Unreliable
<b>U/S</b>	Unserviceable
<b>UTA</b>	Upper control area
<b>UTC</b>	Co-ordinated universal time



**V**

<b>VA</b>	Volcanic ash
<b>VAC</b>	Visual approach chart
<b>VAL</b>	In valleys
<b>VAN</b>	Runway control van
<b>VAR</b>	Visual-aural radio range
<b>VAR</b>	Magnetic variation
<b>VASIS #</b>	Visual approach slope indicator system
<b>VC</b>	Vicinity of the aerodrome ( <i>followed by FG=fog, FC=funnel cloud, SH=showers, PO=dust/sand whirls, BLDU=blowing dust, BLSA=blowing sand or BLSN=blowing snow, e.g. VCFG=vicinity fog</i> )
<b>VCY</b>	Vicinity
<b>VDF</b>	VHF direction-finding station
<b>VER</b>	Vertical
<b>VFR</b>	Visual flight rules
<b>VHF</b>	Very high frequency ( <i>30 to 300 MHz</i> )
<b>VIP</b>	Very important person
<b>VIS</b>	Visibility
<b>VLF</b>	Very low frequency ( <i>3 to 30 kHz</i> )
<b>VLR</b>	Very long range
<b>VMC</b>	Visual meteorological conditions
<b>VOLMET #</b>	Meteorological information for aircraft in flight
<b>VOR</b>	VHF Omnidirectional radio range
<b>VORSEC #</b>	VOR/DME Minimum Sector Altitude Chart
<b>VORTAC #</b>	VOR and TACAN combination
<b>VOT</b>	VOR airborne equipment test facility
<b>VRB</b>	Variable
<b>VSA</b>	By visual reference to the ground
<b>VSP</b>	Vertical speed
<b>VSS</b>	Visual Segment Surface
<b>VTOL</b>	Vertical take-off and landing

**W**

<b>W</b>	West or Western longitude
<b>W</b>	White
<b>WAC</b>	World Aeronautical Chart — ICAO 1:1 000 000
<b>WAFC</b>	World area forecast centre
<b>WB</b>	Westbound
<b>WBAR</b>	Wing bar lights
<b>WDI</b>	Wind direction indicator
<b>WDSPR</b>	Widespread
<b>WED</b>	Wednesday
<b>WEF</b>	With effect from or effective from
<b>WI</b>	Within
<b>WID</b>	Width
<b>WIE</b>	With immediate effect or Effective immediately
<b>WILCO #</b>	Will comply
<b>WITEM</b>	Forecast upper wind and temperature for aviation
<b>WIP</b>	Work in progress
<b>WKN</b>	Weaken or Weakening
<b>WNW</b>	West north-west
<b>WO</b>	Without
<b>WPT</b>	Way-point
<b>WRNG</b>	Warning
<b>WS</b>	Wind shear
<b>WSW</b>	West south-west
<b>WT</b>	Weight
<b>WTSPT</b>	Waterspout
<b>WX</b>	Weather

**X**

<b>X</b>	Cross
<b>XBAR</b>	Crossbar ( <i>of approach lighting system</i> )
<b>XNG</b>	Crossing
<b>XS</b>	Atmospherics

**Y**

**Y**

Yellow

**YCZ**

Yellow caution zone (*runway lighting*)

**YR**

Your

**Z**

**Z**

Co-ordinated universal time

# **Intentionally Blank**

## **GEN 2.3 CHART SYMBOLS**



















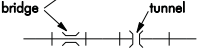

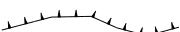



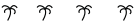






### **1 INTRODUCTION**

#### **1.1 General**

1.1.1 Symbols for enroute charts are shown in the chart legend of the Auckland Oceanic FIR/Nadi FIR enroute chart.



**Figure GEN 2.3-2  
Aerodrome Chart Symbols**

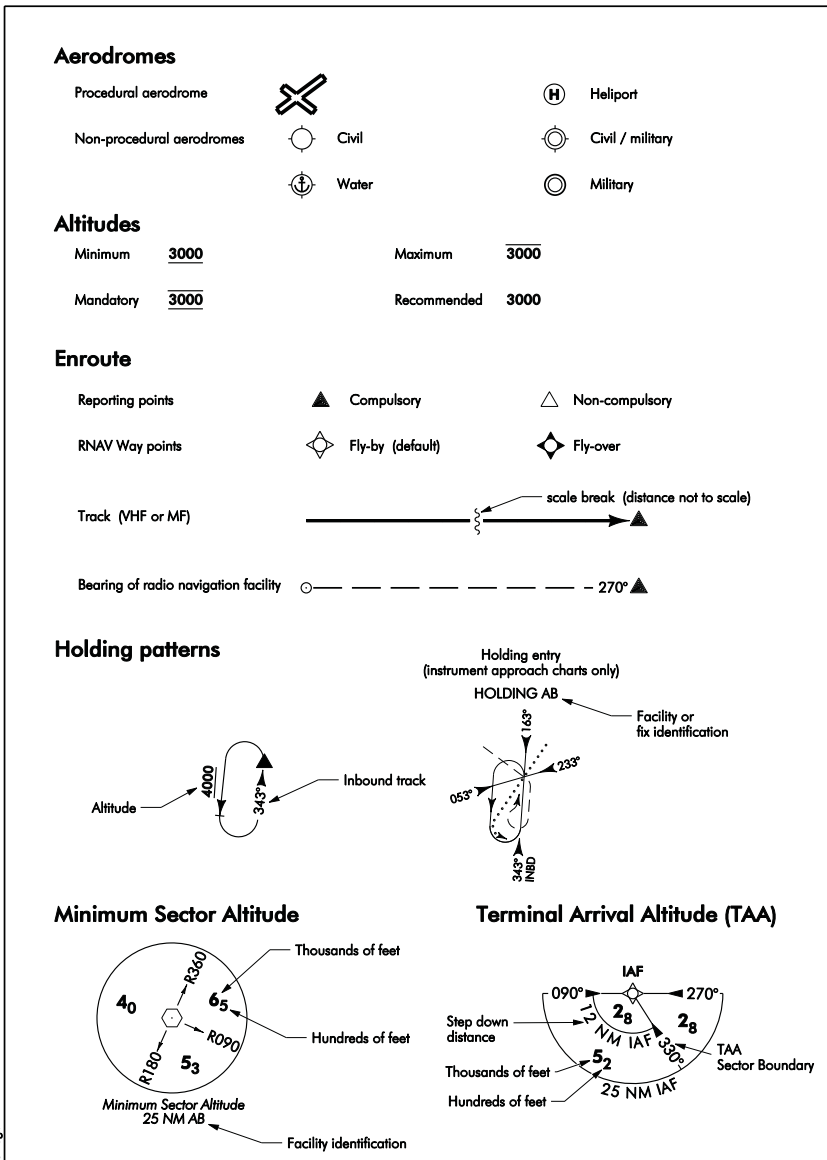
<b>Movement Areas</b>			
aerodrome boundary		permanently unusable area	
caution area (designated)		open drain	
<b>Lighting</b>			
aerodrome beacon		aeronautical light (or hazard beacon)	
circling guidance lights		marine light	
obstruction light		flood light	
<b>Obstacles</b>			
highest elevation on chart		spot elevation	
towers and masts	lighted  100	microwave station or tower	
	unlighted  100	power or telephone line	
<b>Topography</b>			
road		river	
railway		water areas	
cliff or terrace		stopbank	
built-up area		buildings	
		tree	
<b>Miscellaneous</b>			
control tower	 TWR	helicopter park	
flight service station	 FSS	light aircraft park	
telephone		first aid	

C:\Legend2-A

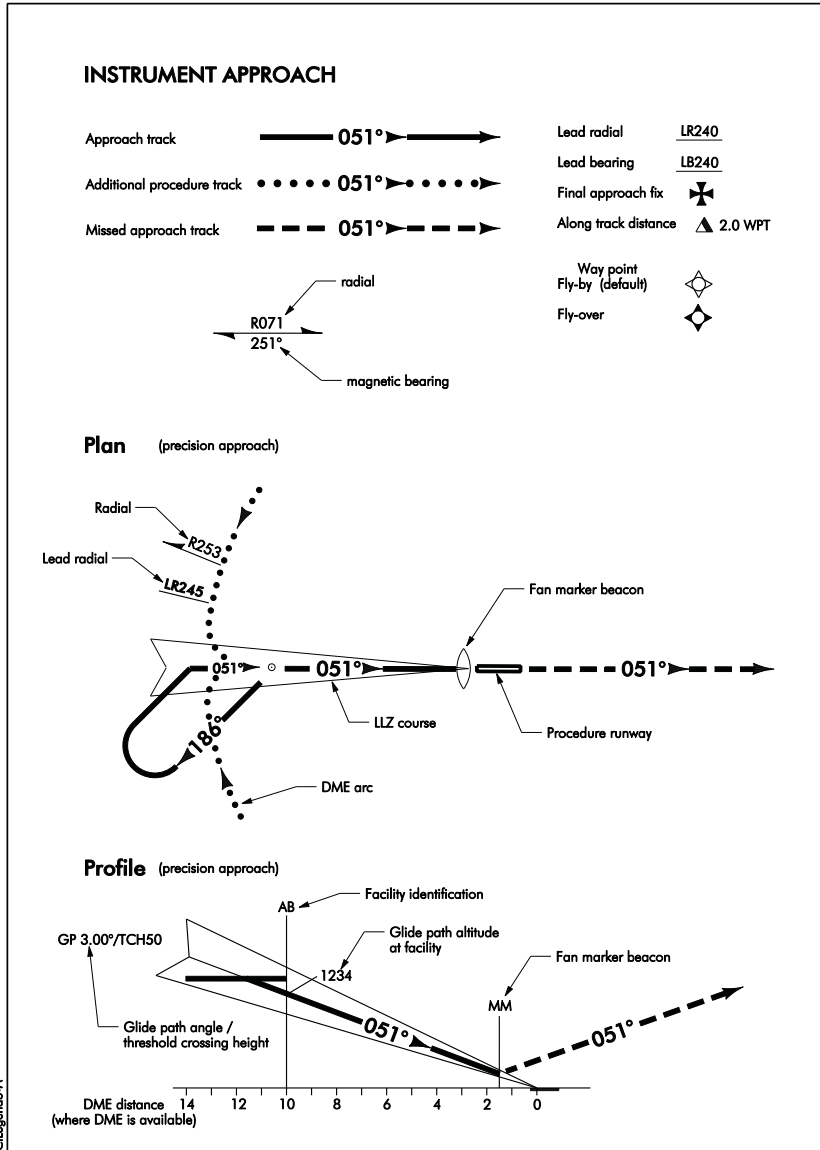




**Figure GEN 2.3-4  
Instrument Chart Symbols**

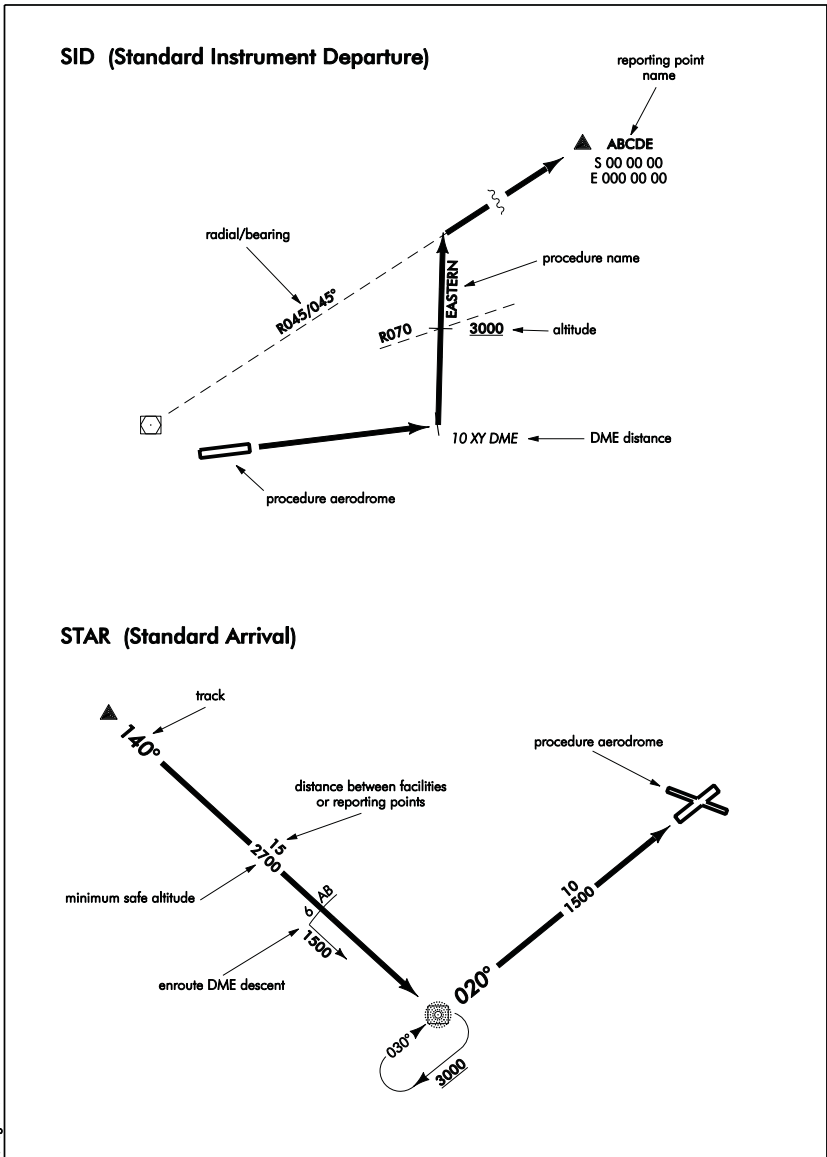


**Figure GEN 2.3-5  
Instrument Chart Symbols**

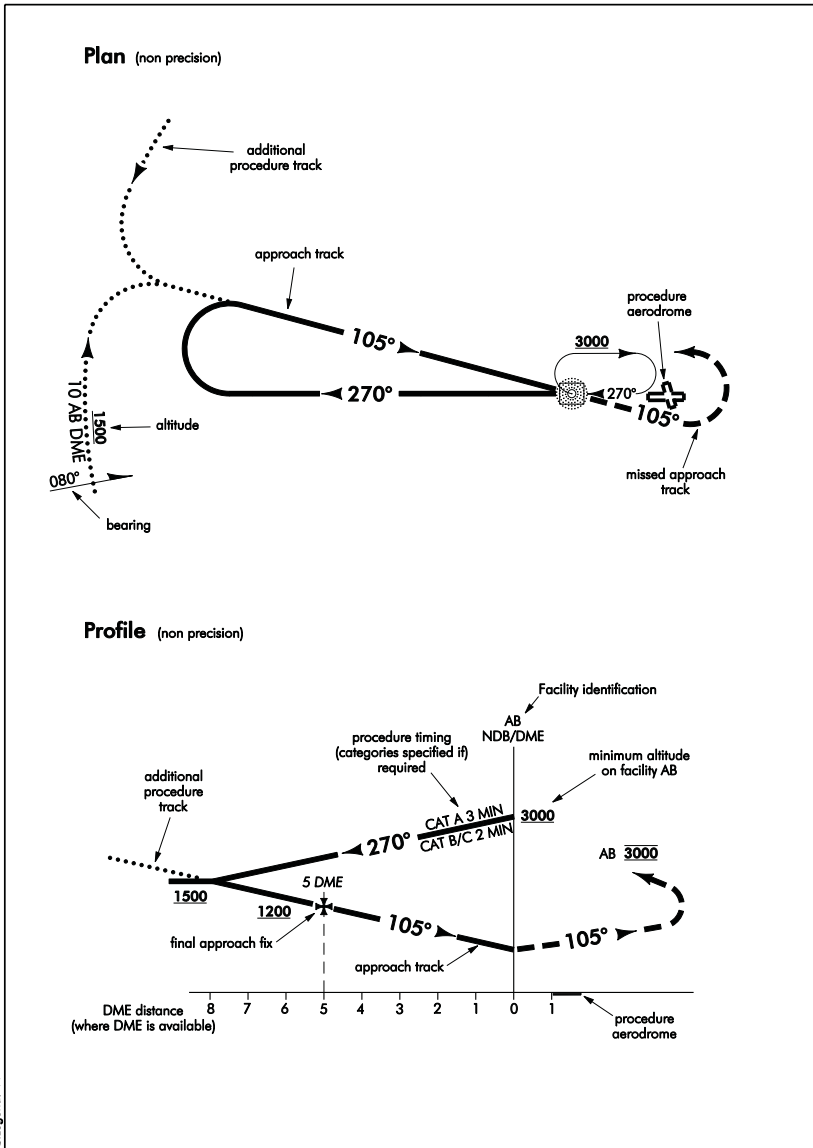


C:\legends\A

Figure GEN 2.3-6  
Instrument Chart Symbols

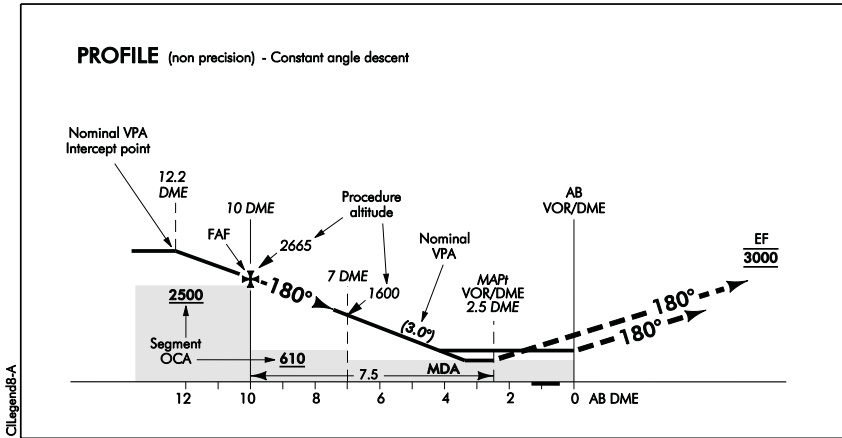


**Figure GEN 2.3-7  
Instrument Chart Symbols**

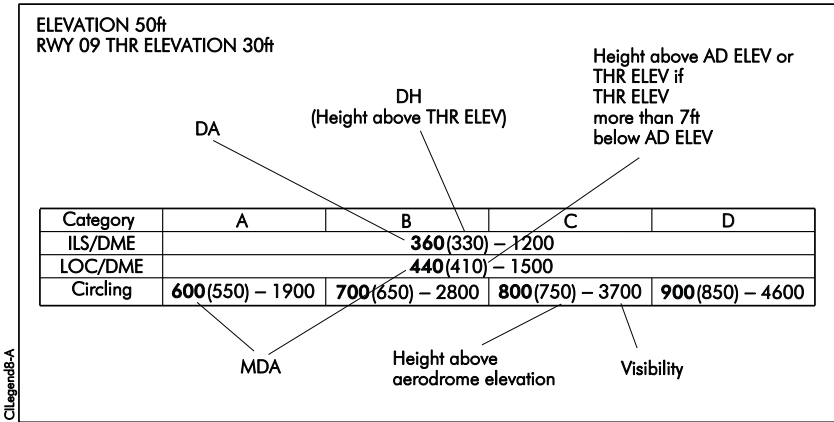


CLegend7-A

**Figure GEN 2.3-8  
Instrument Chart Symbols**



**Figure GEN 2.3-9  
Ground Based Aid Approach**



## GEN 2.4 LOCATION INDICATORS

### 1 INTRODUCTION

#### 1.1 General

1.1.1 The location indicators marked with an asterisk (\*) cannot be used in the address component of AFS messages.

#### 1.2 AFS Addresses

1.2.1 Table GEN 2.4 - 1 list AFS addresses by station name.

**Table GEN 2.4 - 1**  
**AFS Address Encode/Decode**

ENCODE		DECODE	
NAME	LOCATION INDICATOR	NAME	
Aitutaki	NCAI*	NCAI*	Aitutaki
Atiu	NCAT*	NCAT*	Atiu
Mangaia	NCMG*	NCMG*	Mangaia
Manuae	NCMN*	NCMN*	Manuae
Mauke	NCMK*	NCMK*	Mauke
Mitiaro	NCMR*	NCMR*	Mitiaro
Nassau	NCNS*	NCNS*	Nassau
Palmerston	NCPM*	NCPM*	Palmerston
Penrhyn	NCPY*	NCPY*	Penrhyn
Pukapuka	NCPK*	NCPK*	Pukapuka
Rakahanga	NCRK*	NCRK*	Rakahanga
Rarotonga INTL	NCRG	NCRG	Rarotonga INTL
Suvarrow	NCSW*	NCSW*	Suvarrow

# **Intentionally Blank**



## GEN 2.5 LIST OF RADIO NAVIGATION AIDS

### 1 RADIO NAVIGATION AIDS

#### 1.1 Decode

1.1.1 Table GEN 2.5 - 1 lists radio navigation aids alphabetically by station ID.

**Table GEN 2.5 - 1**  
**List of Radio Navigation Aids by ID**

ID	STATION NAME	FACILITY	PURPOSE
AI	Aitutaki	NDB	AE
IAV	Rarotonga	ILS/LOC	A
IAV	Rarotonga	ILS/DME	A
INO	Rarotonga	ILS/LOC	A
INO	Rarotonga	ILS/DME	A
PY	Penrhyn	NDB	AE
RG	Rarotonga	NDB	AE
RG	Rarotonga	VOR	AE
RG	Rarotonga	DME	AE
<b>Key</b>	A = Approach Facility, E = Enroute Facility, AE = Combined Approach and Enroute Facility		

**1.2 Encode**

1.2.1 Table GEN 2.5 - 1 lists radio navigation aids alphabetically by station name.

**Table GEN 2.5 - 2  
List of Radio Navigation Aids by Location**

<b>STATION NAME</b>	<b>FACILITY</b>	<b>ID</b>	<b>PURPOSE</b>
Aitutaki	NDB	AI	AE
Penrhyn	NDB	PY	AE
Rarotonga	NDB	RG	AE
Rarotonga	VOR	RG	AE
Rarotonga	DME	RG	AE
Rarotonga	ILS/DME	INO	A
Rarotonga	ILS/LOC	INO	A
Rarotonga	ILS/DME	IAV	A
Rarotonga	ILS/LOC	IAV	A
<b>Key</b>	A = Approach Facility, E = Enroute Facility, AE = Combined Approach and Enroute Facility		

## GEN 2.6 CONVERSION TABLES

### 1 CONVERSION TABLES

#### 1.1 Unit Conversions

1.1.1 Unit conversions are provided in [Table GEN 2.6 - 1](#).

**Table GEN 2.6 - 1  
Unit Conversions**

TO CONVERT	INTO	MULTIPLY BY	DIVIDE BY
Celsius	Fahrenheit	1.8 and add 32	
Centimetres	Inches	0.3937	2.54*
Fahrenheit	Celsius	Subtract 32 and Multiply by 0.555	Subtract 32 and Divide by 1.8
Feet	Metres	0.3048*	
Imp. Gallons	US Gallons	1.200956	
Imp. Gallons	Litres	4.546092	
Inches	Centimetres	2.54*	
Kilograms	Pounds	2.2046226	
Kilometres	US and International Nautical Miles	0.5399568	
Kilometres	UK Nautical Miles	0.5396118	
Kilopascals	Pounds per square inch	0.14504	
Litres	Imp. Gallons	0.22	
Litres	US Gallons	0.2643	
Metres	Feet	3.2808	0.3048*

TO CONVERT	INTO	MULTIPLY BY	DIVIDE BY
Pounds	Kilograms	0.453592	
Pounds per square inch	Kilopascals	6.894757	
US and International Nautical Miles	Kilometres	1.852*	
UK Nautical Miles	Kilometres	1.853184	
US Gallons	Imp. Gallons	0.83267	
US Gallons	Litres	3.78412	

\* Factors are exact.

## GEN 2.7 SUNSET/SUNRISE TABLES

### 1 SUNSET/SUNRISE TABLES

#### 1.1 General

1.1.1 Table GEN 2.7 - 1 lists the beginning and end of civil twilight in Aitutaki, Penrhyn and Rarotonga.

1.1.2 The times listed in Table GEN 2.7 - 1 are given in LST (Local Standard Time) and UTC (Universal Time Coordinate).

**Table GEN 2.7 - 1**  
**Morning Civil Twilight/Evening Civil Twilight**

LOCATION	MCT	JAN 7	JAN 14	JAN 21	JAN 28	FEB 7	FEB 14	FEB 21	FEB 28	MAR 7	MAR 14	MAR 21	MAR 28
	ECT												
AITUTAKI	LST	0545	0549	0554	0600	0605	0608	0612	0615	0617	0619	0621	0623
	UTC	1545	1549	1554	1600	1605	1608	1612	1615	1617	1619	1621	1623
	LST	1946	1947	1946	1944	1941	1938	1933	1928	1923	1918	1911	1905
	UTC	0546	0547	0546	0544	0541	0538	0533	0528	0523	0518	0511	0505
PENRHYN	LST	0558	0601	0603	0607	0611	0612	0614	0615	0615	0615	0615	0615
	UTC	1558	1601	1603	1607	1611	1612	1614	1615	1615	1615	1615	1615
	LST	1920	1921	1922	1923	1921	1920	1916	1914	1912	1907	1904	1900
	UTC	0520	0521	0522	0523	0521	0520	0516	0514	0512	0507	0504	0500
RAROTONGA	LST	0540	0544	0549	0556	0601	0605	0610	0613	0615	0618	0621	0623
	UTC	1540	1544	1549	1556	1604	1605	1610	1613	1615	1618	1621	1623
	LST	1951	1952	1951	1948	1945	1941	1935	1930	1924	1918	1911	1905
	UTC	0551	0552	0551	0548	0545	0541	0535	0530	0524	0518	0511	0505

LOCATION	MCT	APR 7	APR 14	APR 21	APR 28	MAY 7	MAY 14	MAY 21	MAY 28	JUN 7	JUN 14	JUN 21	JUN 28
	ECT												
AITUTAKI	LST	0626	0626	0628	0630	0633	0635	0637	0640	0643	0645	0647	0648
	UTC	1626	1626	1628	1630	1633	1635	1637	1640	1643	1645	1647	1648
	LST	1857	1852	1848	1843	1838	1835	1834	1833	1832	1833	1835	1836
	UTC	0457	0452	0448	0443	0438	0435	0434	0433	0432	0433	0435	0436
PENRHYN	LST	0614	0613	0613	0614	0614	0615	0616	0617	0619	0621	0623	0624
	UTC	1614	1613	1613	1614	1614	1615	1616	1617	1619	1621	1623	1623
	LST	1854	1851	1848	1845	1843	1841	1841	1841	1842	1842	1845	1846
	UTC	0454	0451	0448	0445	0443	0441	0441	0441	0442	0442	0445	0446
RAROTONGA	LST	0626	0628	0630	0632	0636	0638	0641	0644	0647	0649	0651	0652
	UTC	1626	1628	1630	1632	1636	1638	1641	1644	1647	1649	1651	1652
	LST	1857	1850	1845	1841	1835	1832	1830	1829	1828	1829	1831	1832
	UTC	0457	0450	0445	0441	0435	0432	0430	0429	0428	0429	0431	0432

LOCATION	MCT	JUL 7	JUL 14	JUL 21	JUL 28	AUG 7	AUG 14	AUG 21	AUG 28	SEP 7	SEP 14	SEP 21	SEP 28
	ECT												
AITUTAKI	LST	0649	0649	0647	0645	0642	0637	0633	0628	0621	0614	0608	0601
	UTC	1649	1649	1647	1645	1642	1637	1633	1628	1621	1614	1608	1601
	LST	1839	1841	1844	1846	1848	1850	1851	1853	1854	1855	1857	1859
	UTC	0439	0441	0444	0446	0448	0450	0451	0453	0451	0455	0457	0459
PENRHYN	LST	0625	0626	0626	0626	0624	0621	0618	0615	0610	0606	0602	0557
	UTC	1625	1626	1626	1626	1624	1621	1618	1615	1610	1606	1602	1557
	LST	1848	1849	1850	1851	1852	1852	1852	1852	1850	1850	1849	1849
	UTC	0448	0449	0450	0451	0452	0452	0452	0452	0450	0450	0449	0449
RAROTONGA	LST	0653	0653	0651	0649	0645	0639	0635	0631	0621	0612	0608	0601
	UTC	1653	1653	1651	1649	1645	1639	1635	1631	1621	1614	1608	1601
	LST	1835	1837	1840	1842	1845	1848	1849	1851	1854	1855	1857	1859
	UTC	0435	0437	0440	0442	0445	0448	0449	0451	0454	0454	0457	0459

LOCATION	MCT	OCT 7	OCT 14	OCT 21	OCT 28	NOV 7	NOV 14	NOV 21	NOV 28	DEC 7	DEC 14	DEC 21	DEC 28
	ECT												
AITUTAKI	LST	0554	0548	0543	0538	0534	0531	0529	0528	0529	0537	0534	0538
	UTC	1554	1548	1543	1538	1534	1531	1529	1528	1529	1531	1534	1538
	LST	1900	1902	1904	1908	1912	1916	1921	1926	1932	1936	1940	1943
	UTC	0500	0502	0504	0508	0512	0516	0521	0526	0532	0536	0540	0543
PENRHYN	LST	0551	0549	0546	0542	0539	0539	0539	0540	0542	0544	0548	0551
	UTC	1551	1549	1546	1542	1539	1539	1539	1540	1542	1544	1548	1551
	LST	1848	1849	1849	1850	1852	1854	1858	1900	1905	1909	1913	1916
	UTC	0448	0449	0449	0450	0452	0454	0458	0500	0505	0509	0512	0516
RAROTONGA	LST	0552	0546	0541	0535	0530	0527	0525	0523	0524	0526	0529	0533
	UTC	1552	1546	1541	1535	1530	1527	1525	1523	1524	1526	1529	1533
	LST	1902	1904	1906	1911	1916	1920	1927	1931	1937	1941	1945	1948
	UTC	0502	0504	0506	0511	0516	0520	0527	0531	0537	0541	0545	0448

# GEN 3 SERVICES





## GEN 3.1 AERONAUTICAL INFORMATION SERVICES

### 1 RESPONSIBLE SERVICE

#### 1.1 General

1.1.1 The Aeronautical Information Service ensures the flow of information necessary for the safety, regularity and efficiency of international and domestic air navigation within the area of its responsibility as indicated in GEN 2.1.1. It consists of:

Air Traffic Services  
PO Box 90  
Airport Authority  
Rarotonga International Airport  
COOK ISLANDS

TEL (682) 25 890 ext 213  
FAX (682) 21 890  
AFTN NCRGZPX  
Email ats\_ops@airport.gov.ck  
OPS Hours HS

1.1.2 Preflight aeronautical information and flight planning service is available at the Air Traffic Control Tower building at Rarotonga International airport.

#### 1.2 Aeronautical Information Service Providers

1.2.1 Aeropath, the company contracted by CAANZ, provides aeronautical information services within the Cook Sector area of responsibility of the Auckland Oceanic FIR.

1.2.2 Aeropath is certificated by CAANZ under CAR Part 175 to provide the AIP service. The Aeronautical Information Management unit is located in Wellington and provides the AIP service for the Cook Islands.

Aeropath  
PO Box 294  
Wellington 6140  
NEW ZEALAND

Tel +64 4 471 1899  
Website [www.aipshop.co.nz](http://www.aipshop.co.nz)  
Email aim@aeropath.aero

### 1.3 International NOTAM Office (NOF)

1.3.1 Aeropath is certificated by CAA of NZ under Part 175 to provide the NOTAM Service. The International NOF is located at the Christchurch ATCC and publishes NOTAMs for the Cook Islands area of responsibility in the Auckland Oceanic FIR.

International NOTAM office  
c/- Airways Corporation of New Zealand Ltd  
PO Box 14-131  
Christchurch Airport  
Christchurch  
NEW ZEALAND

TEL (64) 3 358 1688  
FAX (64) 3 358 9192

AFTN NZCHYNYX  
Website [www.ifis.airways.co.nz](http://www.ifis.airways.co.nz)

1.3.2 The service is provided in accordance with the provisions contained in ICAO Annex 15 — *Aeronautical Information Services*.

1.3.3 NOTAM may be requested from the AIS Briefing Office and Christchurch Notam Office, New Zealand.

## 2 AREA OF RESPONSIBILITY

### 2.1 General

2.1.1 The Aeronautical Information Service is responsible for the collection and dissemination of information for the entire territory of the Cook Islands and for the airspace encompassed by the Cook Sector and Rarotonga CTR/CTA of the Auckland Oceanic FIR.

2.1.2 Responsibility for the provision of AIS within the Cook Sector of the Auckland Oceanic FIR is vested in the Airport Authority under the delegation from the Ministry of Transport, Cook Islands.

### **3 AERONAUTICAL PUBLICATIONS**

#### **3.1 General**

3.1.1 The aeronautical information is provided in the form of the Integrated Aeronautical Information Package consisting of the following elements:

- (a) Aeronautical Information Publication (AIP — Cook Islands)
- (b) Amendment service to the AIP (AIP AMDT — Cook Islands)
- (c) AIP Supplement (AIP SUP — Cook Islands)
- (d) NOTAM
- (e) Aeronautical Information Circulars (AIC)
- (f) Checklists and summaries

#### **3.2 Aeronautical Information Publication**

3.2.1 The AIP — Cook Islands consists of this manual and is published in loose leaf form for use in international and domestic operations.

3.2.2 AIRAC AIP amendments are published to incorporate permanent amendments to the AIP — Cook Islands. A Bulletin is published with each AIRAC AIP amendment, listing a summary of significant changes. AIRAC AIP amendments are issued as scheduled in [Table GEN 0.1 - 1](#).

3.2.3 A revised Checklist of Effective Pages and Charts is issued with each AIRAC AIP amendment.

#### **3.3 Supplements to the AIP**

3.3.1 The AIP Supplement — Cook Islands is published for temporary changes of long duration (3 months and longer) and information of short term duration which consists of extensive text and/or graphics. AIP Supplements may be issued on any of the available AIRAC dates.

3.3.2 The AIP Supplement — Cook Islands is issued as a separate document, with each edition entirely replacing the previous edition. A checklist of current AIP Supplements is published on the front page of the AIP Supplement document.

**3.4 NOTAM and Pre-flight Information Bulletins (PIB)**

3.4.1 Rarotonga Air Traffic Services will provide, on request, customised pre-flight information bulletins for regular air transport operations. Pre-flight Information bulletins for itinerant operations may be requested from:

Air Traffic Services  
PO Box 90  
Airport Authority  
Rarotonga International Airport  
COOK ISLANDS

TEL (682) 25 890 ext 213  
FAX (682) 21 890  
AFTN NCRGZPZX  
Email ats\_ops@airport.gov.ck  
OPS Hours HS

**D****3.5 Aeronautical Information Circulars**

3.5.1 AICs are originated whenever it is desirable to promulgate:

- (a) a long term forecast of any major change in legislation, regulations, procedures or facilities;
- (b) information of a purely explanatory or advisory nature likely to affect flight safety;
- (c) information or notification of an explanatory or advisory nature concerning technical, legislative or purely administrative matters.

3.5.2 Each AIC is numbered consecutively on a calendar year basis. A checklist of AIC currently in force is issued as an AIC in January each year and the serial number 1 is reserved for this.

### 3.6 Checklists and Summary of NOTAM

3.6.1 A summary of current NOTAM is produced at the beginning of each month by the Christchurch Intl NOTAM Office.

### 3.7 Sale of Publications

3.7.1 The AIP — Cook Islands, AIP Supplement — Cook Islands are available from Aeropath.

3.7.2 Copies of these documents and enroute charts are available from Aeropath at the address below. Prices are available on request.

Aeropath  
PO Box 294  
Wellington 6140  
NEW ZEALAND

TEL (64) 4 471 1899  
FAX (64) 4 471 5813

D

AFTN NZHQYOYX

Email [aim@aeropath.aero](mailto:aim@aeropath.aero)  
website [www.aipshop.co.nz](http://www.aipshop.co.nz)

## 4 AIRAC SYSTEM

### 4.1 General

4.1.1 Amendments to the AIP — Cook Islands are published in accordance with the ICAO AIRAC schedule. The AIRAC schedule is established to ensure coordination between adjacent states for the implementation of changes, and to ensure information is available to interested organisations (e.g. airline flight operations) in sufficient time to assess and implement changes relevant to their operation.

4.1.2 Amendments may be published on any scheduled date. The schedule has an interval of 28 days starting from and including 10 January 1991. States are not required to publish on every available date, but should ensure that any changes are coordinated with available dates. The scheduled publication dates for AIP — Cook Islands are listed in [Table GEN 0.1 - 1](#).

4.1.3 To allow interested organisations sufficient time to assess and implement changes, amendments are distributed to users at least 28 days before the effective date. In the case of changes that are likely to have significant operational impact, amendments should be distributed to users at least 56 days before the effective date.

## **5 PRE-FLIGHT INFORMATION SERVICE AT AERODROMES**

### **5.1 General**

5.1.1 Pre-flight briefings at Rarotonga INTL airport is by prior arrangement to the Rarotonga Air Traffic Services. Rarotonga is the only international airport within the Cook Islands that provides this service for the other small domestic airport Aitutaki and the unattended aerodromes within the Cook Sector of the Auckland Oceanic FIR.

TEL	(682) 25 890 ext 213
FAX	(682) 21 890
AFTN	NCRGZPZX

**D**

## GEN 3.2 AERONAUTICAL CHARTS

### 1 RESPONSIBLE SERVICE

#### 1.1 General

1.1.1 Ministry of Transport Cook Islands is responsible for the provision of aeronautical charts. Aeronautical charts are published by Aeropath, the AIP service provider in New Zealand.

### 2 MAINTENANCE OF CHARTS

#### 2.1 General

2.1.1 Aeronautical charts are maintained by Aeropath. Amendments to aeronautical charts are published as per NZAIP AIRAC cycle.

#### 2.2 Purchase Arrangements

2.2.1 Refer to [GEN 3.1. paragraph 3.7.](#)

#### 2.3 Aeronautical Chart Series Available

2.3.1 The following charts series are published in the AIP — Cook Islands:

- (a) Aerodrome Chart — ICAO
- (b) Instrument Approach Chart — ICAO
- (c) Enroute Chart — ICAO

#### 2.4 List of Aeronautical Charts Available

2.4.1 The following charts series are available:

- (a) Enroute Chart — Auckland Oceanic FIR/Nadi FIR

#### 2.5 Index to the World Aeronautical Charts (WAC) — ICAO 1:1 000 000

2.5.1 Nil published.

**2.6 Topographical Charts**

2.6.1 Aeronautical Topographical Charts are not published.

**2.7 Corrections to Charts not Contained in the AIP**

2.7.1 Reserved



## GEN 3.3 AIR TRAFFIC SERVICES

### 1 RESPONSIBLE SERVICE

#### 1.1 General

1.1.1 Cook Islands Airport Authority is the responsible authority for the provision of air traffic services within the area indicated under [GEN 3.3. paragraph 2.1.1](#).

1.1.2 The services are provided in accordance with the provisions contained in the following ICAO documents:

- (a) Annex 2 — *Rules of the Air*
- (b) Annex 11 — *Air Traffic Services*
- (c) Doc 4444 — *Procedures for Air Navigation Services — Rules of the Air and Air Traffic Services (PANS – RAC)*
- (d) Doc 8168 — *Procedures for Air Navigation Services — Aircraft Operations (PANS – OPS)*
- (e) Doc 7030 — *Regional Supplementary Procedures*

1.1.3 Differences to these provisions are detailed in [GEN 1.7](#).

### 2 AREA OF RESPONSIBILITY

#### 2.1 General

2.1.1 Responsibility for the provision of Air Traffic Services within the Cook Sector and the Rarotonga CTR/CTA of the Auckland Oceanic FIR is vested in the Rarotonga ATS unit. Outside hours of operation of Rarotonga ATS unit, flight information services and alerting services are provided by Auckland Oceanic. Hours of operation are advised by NOTAM.

### **3 TYPES OF SERVICES**

#### **3.1 General**

3.1.1 The following types of services are provided at Rarotonga during published hours of ATC:

- (a) Flight Information Service (FIS) and Alerting Service (ALRS)
- (b) Approach Control (APP)
- (c) Aerodrome Control (TWR)

3.1.2 The types of services are provided at Rarotonga during published hours of Flight Service (FS):

- (a) Aerodrome Flight Information Service (AFIS) and Alerting Service (ALRs)

3.1.3 ATC services shall be provided for scheduled and non-scheduled international and private flights, foreign and military flights and to flights on a diversion.

3.1.4 FS shall be provided to domestic aircraft during domestic operations. In the event of an international arrival during these times, ATC takes precedence.

#### **3.2 ATC Contingency Service**

3.2.1 An ATC contingency plan exists between Rarotonga ATS and Auckland Oceanic. Activation of contingency procedures will be advised by NOTAM.

## 4 CO-ORDINATION BETWEEN THE OPERATORS AND ATS

### 4.1 General

4.1.1 Co-ordination between the operator and air traffic services is effected in accordance with 2.15 of ICAO Annex 11 and 2.1.1.4 and 2.1.1.5 of Part VIII of the Procedures for Air Navigation Services — *Rules of the Air and Air Traffic Services* (Doc 4444, PANS – RAC).

## 5 ATS UNITS ADDRESS LIST

### 5.1 General

5.1.1 [Table GEN 3.3 - 1](#) lists the contact addresses for all ATS units in the Cook Islands.

**Table GEN 3.3 - 1**  
**ATS Unit Contact Addresses**

UNIT NAME	POSTAL ADDRESS	TELEPHONE	FAX	TELEX	AFS ADDRESS
<b>Rarotonga ATS</b>	Cook Islands Airport Authority PO Box 90 Rarotonga COOK ISLANDS	(682) 25 890 ext 202 or ext 213	(682) 21 890	Nil	NCRGZPZX

## **6 MINIMUM FLIGHT ALTITUDE**

### **6.1 Minimum Safe Altitude**

6.1.1 The route minimum safe altitude (MSA) is found by identifying the controlling obstacle within the total area of the navigational tolerance, based on the type and coverage of the navigation facilities, plus a 5NM buffer. Within this area the MSA is the lowest altitude, rounded up to the next 100ft, which provides an obstacle clearance of at least 1,000ft.

6.1.2 Set heading and minimum crossing altitudes are based on a 1.6% (100ft/NM) gradient while maintaining enroute terrain clearances.

6.1.3 Route MSA are shown on each sector of enroute charts for domestic routes. These provide the basis for establishing the minimum cruising altitude for the direction of flight. The requirements for subsequent sectors should be anticipated by crossing the facility or reporting point at or above a cruising level that is not below the MSA for the next sector. Greater obstacle clearances may be needed in adverse weather conditions or when navigational guidance is inadequate.

### **6.2 Minimum Reception Altitude and Minimum Enroute Altitude**

6.2.1 Where an acceptable navigational signal coverage is a requirement for a sector to be flown, a minimum reception altitude (MRA) or minimum enroute altitude (MEA) will be published.

6.2.2 For a VOR route, the published MRA will ensure adequate signal strength for accurate navigation. Although some low sensitivity VOR receivers may not display a warning at altitudes below the published MRA, the altitude or flight level for IFR flights using VOR as the primary means of navigation must be at or above the published MRA.

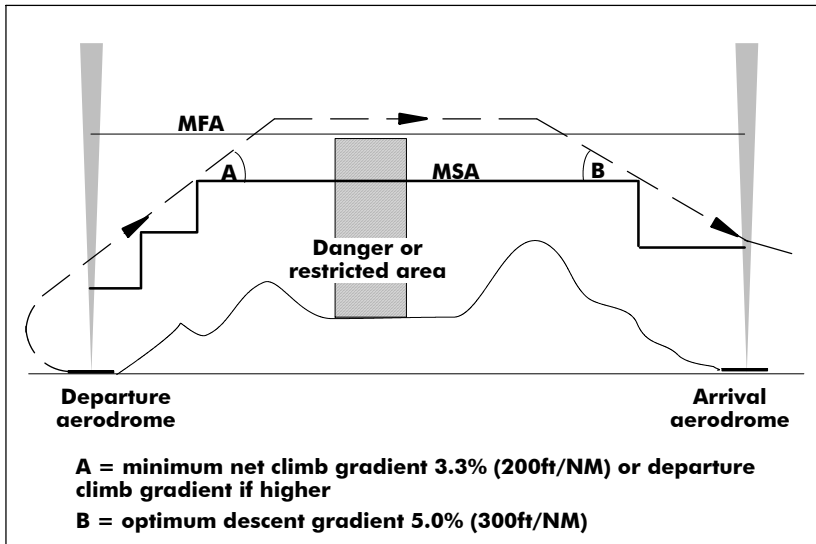
6.2.3 The published MEA for an NDB route will ensure acceptable navigational signal coverage for the sector to be flown. Where an MEA is published, IFR flights using NDB as the primary means of navigation, must be at or above the published MEA.

### 6.3 Minimum Flight Altitude

6.3.1 As shown in [Figure GEN 3.3 - 1](#), the minimum flight altitude (MFA) for an IFR route sector will be the higher of the following:

- Route minimum safe altitude (MSA);
- Minimum reception altitude (MRA) for a VOR sector;
- Minimum enroute altitude (MEA) for an NDB sector;
- Danger or restricted area upper limit plus 1,000ft.

**Figure GEN 3.3 -1  
Minimum Flight Altitude**



6.3.2 The requirements of the IFR table of cruising levels must then be taken into account.

6.3.3 Where the next route sector MFA is higher, that sector must not be entered below the higher level unless there is a promulgated crossing altitude.

6.3.4 Aircraft with approved enroute area navigation equipment are not required to comply with MRA and MEA restrictions.

#### **6.4 Climb to MFA**

6.4.1 To ensure obstacle clearance, aircraft on departure are required to climb to MSA at the promulgated minimum net climb gradient appropriate to the departure procedure being flown. Unless a more restrictive requirement is published, once above MSA, aircraft may continue to climb at a minimum net climb gradient of not less than 3.3% (200ft/NM) to MFA.

#### **6.5 Descent Below MFA**

6.5.1 Descent below MFA prior to arrival may only be commenced in the following circumstances:

- (a) In accordance with published DME steps, or
- (b) Prior to the first DME step when:
  - (i) A positive fix has been established by an unambiguous DME readout for at least 15 seconds, or by the use of an off-track VOR or NDB provided the angle of intersection is 45° or greater, and
  - (ii) A positive tracking indication has been received by navigation equipment for at least 15 seconds, and
  - (iii) During descent, aircraft navigation equipment is actively monitored to ensure continuity of guidance.
  - (iv) Descent is restricted to the higher of MSA or danger or restricted area upper limit plus buffer, and based on an optimum descent gradient of 5% (300ft/NM) to the first DME step.

6.5.2 Within 10NM of the aid or fix from which it is intended to conduct an instrument approach, descent is limited to the higher of minimum holding altitude, procedure commencement altitude or MSA.

#### **Note**

Outside controlled airspace the IFR table of cruising levels applies.

#### **6.6 Emergency Descent Below MFA**

6.6.1 Where an enroute emergency necessitates a descent below MEA or MRA, pilots should be aware that the navigational tolerance used to define the MSA may not be valid if the utilisation of the primary means of navigation can be continued. A decision to continue to divert to another route must consider the accuracy of navigation prior to the emergency.

## GEN 3.4 COMMUNICATION SERVICES

### 1 RESPONSIBLE SERVICE

#### 1.1 General

1.1.1 The responsible service for the provision of telecommunication and navigation facility services in the Cook Islands is the Cook Islands Airport Authority.

1.1.2 Aeronautical telecommunication services for ATS and the Cook Islands air navigation service are administered by the Cook Islands Airport Authority. The following services are provided:

(a) Radio Navigation

Cook Islands Airport Authority  
PO Box 90  
NIKAO  
Rarotonga  
COOK ISLANDS

TEL (682) 25 890  
FAX (682) 21 890

AFTN NCRGYFYX

(b) Communications

Cook Islands Airport Authority  
PO Box 90  
NIKAO  
Rarotonga  
COOK ISLANDS

TEL (682) 25 890  
FAX (682) 21 890

AFTN NCRGYFYX

1.1.3 The service is provided in accordance with the provisions contained in the following ICAO documents:

- (a) Annex 10 — *Aeronautical Telecommunications*
- (b) Doc 8400 — *Procedures for Air Navigation Services — ICAO Abbreviations and Codes (PANS - ABC)*
- (c) Doc 8585 — *Designators for Aircraft Operating Agencies, Aeronautical Authorities and Services*
- (d) Doc 7030 — *Regional Supplementary Procedures*
- (e) Doc 7910 — *Location Indicators*

## **2 AREA OF RESPONSIBILITY**

### **2.1 General**

2.1.1 Communication services are provided for the Cook Sector of the Auckland FIR.

## **3 TYPES OF SERVICE**

### **3.1 Radio Navigation Services**

3.1.1 The following types of radio aids to navigation are available:

- (a) LF/MF non-directional beacon (NDB)
- (b) VHF omnidirectional radio range (VOR)
- (c) Distance measuring equipment (DME)
- (d) Instrument Landing System (ILS)

### **3.2 Mobile/Fixed Service**

#### ***Mobile Service***

3.2.1 Air-ground communications in Cook Islands airspace are conducted by radiotelephony (RTF) in the VHF and HF bands. Frequencies and services are published in [Table ENR 2.1 - 1](#).

3.2.2 VHF is the primary frequency band for all operations with HF being used when outside VHF coverage.



**Fixed service**

3.2.3 The messages to be transmitted over the Aeronautical Fixed Service (AFS) are accepted only if:

- (a) they satisfy the requirements of ICAO Annex 10, Vol. II, Chapter 3, 3.3
- (b) they are prepared in the form specified in ICAO Annex 10
- (c) the text of an individual message does not exceed 200 groups

3.2.4 General aircraft operating agency messages are only accepted for transmission to countries that have agreed to accept Class "B" traffic.

**Telephone facilities**

3.2.5 With the exception of Rarotonga and Aitutaki where telephone facilities are readily available, telephone facilities for use by foreign or private pilots at unattended aerodromes in the Cook Islands are generally available through Air Rarotonga handling agents on these islands.

**3.3 Broadcasting Service**

3.3.1 Nil.

**3.4 Language Used**

3.4.1 English.

**3.5 Where Detailed Information can be Obtained**

3.5.1 Details of the various facilities available for enroute traffic can be found in Part 2 (ENR).

3.5.2 Details of the facilities available at the individual aerodromes can be found in the relevant Sections of Part 3 (AD). In cases where a facility is serving both enroute traffic and aerodromes, details are given in the relevant sections of Part 2 (ENR) and Part 3 (AD).

**3.6 Hours of Service**

3.6.1 The hours of service for aeronautical ground services are published in the AIP Supplement — Cook Islands or by NOTAM.

### **3.7 Extended Service**

3.7.1 Extended service may be provided by an aeronautical ground services unit (ATS or RFFS) as an extension to its promulgated hours of service either by opening watch earlier or by closing watch later.

3.7.2 Extended service is normally provided only in the following cases:

- (a) disrupted regular air transport flights (domestic and international);
- (b) approved special air transport flights;
- (c) disaster relief flights;
- (d) medivac flights;
- (e) visiting overseas military and state flights.
- (f) Diversions

#### **Note**

Provided sufficient notice is given, all reasonable efforts will be made to contact the appropriate agencies in order to accommodate requests to extend services at such short notice.

For diversions from Tahiti, at least 30 minutes will be required for availability for ATC coverage

## **4 REQUIREMENTS AND CONDITIONS**

### **4.1 General**

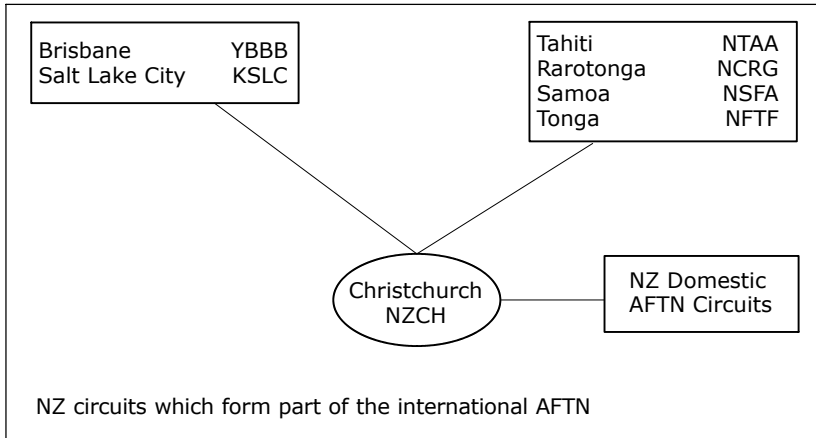
4.1.1 Communication services are available during published hours or by prior arrangement only.

## 5 AFTN CIRCUITS

### 5.1 General

5.1.1 AFTN circuits are shown in [Figure GEN 3.4 - 1](#).

**Figure GEN 3.4-1  
AFTN Circuits**

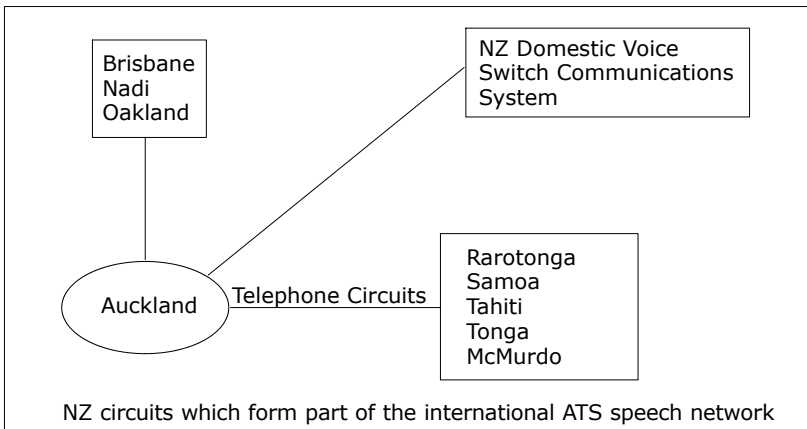


## 6 ATS SPEECH CIRCUITS

### 6.1 General

6.1.1 ATS speech circuits are shown in [Figure GEN 3.4 - 2](#).

**Figure GEN 3.4-2  
ATS Speech Circuits**



## GEN 3.5 METEOROLOGICAL SERVICES

### 1 RESPONSIBLE SERVICE

#### 1.1 General

1.1.1 The Rarotonga meteorological office is located at the northwestern tip of Rarotonga International Airport runway on the seaside.

1.1.2 The meteorological services for civil aviation are provided by the Cook Islands Meteorological Service.

Meteorological Service  
PO Box 127  
Rarotonga  
COOK ISLANDS

TEL (682) 20 603  
FAX (682) 21 603

AFTN NCRGYMYX

Email [mot.weather@cookislands.gov.ck](mailto:mot.weather@cookislands.gov.ck)

1.1.3 The service is provided in accordance with the provisions contained in the following ICAO documents:

- (a) Annex 3 — Meteorological Service for Cook Sector of the Auckland FIR
- (b) Doc 7030 — Regional Supplementary Procedures
- (c) Differences to these provisions are detailed in [GEN 1.7](#).

### 2 AREA OF RESPONSIBILITY

#### 2.1 General

2.1.1 Meteorological services are provided for the Cook Sector of the Auckland FIR.

### **3 METEOROLOGICAL OBSERVATIONS AND REPORTS**

#### **3.1 Description of Observation System**

##### ***Surface Wind***

3.1.1 Surface wind measurements for domestic aerodrome weather reports are made at varying distances from the runway, sometimes greater than one nautical mile.

3.1.2 In the aerodrome weather reports the surface wind direction is given in degrees relative to geographic North (true) and speed in knots.

##### ***Visibility***

3.1.3 When the visibility is 5km or less it shall be expressed in metres and in increments of 100 metres. When it is more than 5km but less than 10km the units will be kilometres, and when it is 10km or more it shall be given as 10km except when the conditions for use of CAVOK apply.

##### ***Present Weather***

3.1.4 Present weather is reported as follows:

(a) Precipitation

- (i) DZ Drizzle
- (ii) RA Rain
- (iii) GR Hail

(b) Obscurations

- (i) FG Fog (Reported when visibility is less than 1000m except when qualified by 'MI' or 'VC')
- (ii) BR Mist (Reported when visibility is at least 1000m but not more than 3000m)

(c) Obscurations (lithometeors)

3.1.5 The following should be used only when the obscuration consists predominantly of lithometeors and the visibility is 3000m or less.

- (i) HZ Haze
- (ii) FU Smoke
- (iii) VA Volcanic Ash

- (d) Other Phenomena
  - (i) SQ Squall
  - (ii) FC Funnel Cloud (Tornado or Waterspout)

***Present Weather***

3.1.6 The characteristics of the present weather phenomena are indicated as follows:

- (a) Characteristics
  - (i) TS Thunderstorm
  - (ii) SH Shower
  - (iii) MI Shallow (less than 2m above ground)
  - (iv) BC Patches (fog patches or aerodrome partially covered by fog)

***Relative Intensity or Proximity of Present Weather***

3.1.7 The relative intensity or, as appropriate, the proximity to the aerodrome of the present weather phenomena is indicated as follows:

- (a) Relative Intensity or Proximity
  - (i) FBL - Light
  - (ii) MOD Moderate
  - (iii) HVY + Heavy
  - (iv) VC Vicinity

**Cloud**

3.1.8 Cloud amount is reported using the abbreviations "FEW" (1 – 2 oktas), "SCT" (3 – 4 oktas), "BKN" (5 – 7 oktas) or "OVC" (8 oktas). If there are no clouds and the abbreviation "CAVOK" is not appropriate, the abbreviation "SKC" may be used. When several layers or masses of cloud are observed, their amount and height are reported as follows:

- (a) the lowest layer or mass, regardless of amount as FEW, SCT, BKN or OVC;
- (b) the next layer or mass, covering more than 2/8 as SCT, BKN, or OVC as appropriate;
- (c) the next higher layer or mass, covering more than 4/8 as BKN or OVC as appropriate;
- (d) CB whenever observed and not reported in the layers above.

**CAVOK**

3.1.9 The term "CAVOK" (KAV-OH-KAY) may replace the information on visibility, present weather and cloud amount, type and height when the following simultaneous conditions exist at the time of observation:

- (a) Visibility — 10km or more
- (b) Cloud — no cloud below 5,000ft and no cumulonimbus
- (c) Weather — no precipitation and no thunderstorm

**Air Temperature and Dew Point Temperature**

3.1.10 Air temperature and dew point temperature if required will be given in whole degrees Celsius.

**Pressure Values**

3.1.11 Pressure values are given in hectopascals, and rounded down to the nearest lower whole hectopascal. For example QNH 995.6 hPa is given as "QNH 995".



**Extra Information**

3.1.12 Visibility and cloud height are estimated by meteorological staff, but when additional information or advice is necessary for landing or take-off purposes, complementary meteorological information may be supplied by the appropriate ATS staff and passed by radio.

**Units of Measurement**

3.1.13 The units of measurement for meteorological purposes are in accordance with ICAO Annex 5.

**Table GEN 3.5 - 1  
Meteorological Observations and Reports**

NAME OF STATION/ LOCATION INDICATOR	TYPE & FREQ OF OBSERVATION/ AUTOMATIC OBSERVING EQUIPMENT	TYPES OF MET REPORTS & SUPPLEMENTARY INFORMATION INCLUDED	OBSERVATION SYSTEM & SITES	HOURS OF OPERATION	CLIMATOLOGICAL INFORMATION
Rarotonga NCRG	Every 3 hours	Synoptic Reports METAR SPECI	Marval	H24	Yes
Aitutaki NCAI	Every 3 hours	Synoptic Reports	AWS	H24	Yes
Mangaia NCMG	Every 3 hours	Synoptic Reports	AWS	H24	Yes
Mauke NCMK	Every 3 hours	Synoptic Reports	AWS	H24	Yes
Manihiki NCMH	Every 3 hours	Synoptic Reports	AWS	H24	Yes
Penrhyn NCPY	Every 3 hours	Synoptic Reports	AWS	H24	Yes
Pukapuka NCPK	Every 3 hours	Synoptic Reports	AWS	H24	Yes

## **4 TYPES OF SERVICES**

### **4.1 General**

4.1.1 The main meteorological office is situated at Rarotonga International Airport.

4.1.2 A daily Area Forecast (ARFOR) is provided by the office for the Cook Islands area.

4.1.3 Route Forecasts (ROFOR) and Terminal Area Forecasts (TAF) are provided by the Meteorological Office if prior request has been received.

4.1.4 Documentation is available for domestic and international flights at the Meteorological Office at Rarotonga International Airport.

## **5 NOTIFICATION REQUIRED FROM OPERATORS**

### **5.1 General**

5.1.1 Requests for forecasts, briefing, flight documentation and any other meteorological information or any changes in existing meteorological reports shall notify, sufficiently in advance (ref ICAO Annex 3, 2.3 ) the meteorological office. The minimum amount of advance notice required shall be 24 hours for domestic operations and intercontinental flights.

5.1.2 TAF and daily international aerodrome forecast are available from the Meteorological Office at Rarotonga International Airport.

5.1.3 It should be understood that the specific value of any of the elements given in a forecast is necessarily approximate. Accordingly, the value of the element in question should be interpreted as representing the most probable mean of a range of values which the element may assume during the period of the forecast concerned. Similarly, when the time of the occurrence or change of an element is given in a forecast the time should be interpreted as representing the most probable mean of a range of times.

## **6 AIRCRAFT REPORTS**

### **6.1 General**

6.1.1 Special observation (AIREP SPECIAL) shall be made by all aircraft operating on ATS routes and addressed to the Meteorological Office at Rarotonga, or New Zealand Meteorological Office via appropriate ATS Unit.

6.1.2 Observations shall be made by all aircraft as soon as it is practicable, of meteorological conditions encountered during climb-out or approach phases of flight, not previously reported to the pilot-in-command, which in their opinion are likely to affect the safety of other aircraft operations.

6.1.3 Pilots should notify Air Traffic Services immediately of any phenomenon which indicates that a volcanic eruption is developing.

## **7 VOLMET SERVICE**

### **7.1 General**

7.1.1 Nil

## **8 SIGMET SERVICE**

### **8.1 General**

8.1.1 Is provided by the Fiji Meteorological Service.

## **9 OTHER AUTOMATED METEOROLOGICAL SERVICES**

### **9.1 General**

9.1.1 Nil

# **Intentionally Blank**

## GEN 3.6 SEARCH AND RESCUE

### 1 RESPONSIBLE SERVICES

#### 1.1 General

1.1.1 The search and rescue service in the Cook Islands provided by New Zealand is co-ordinated by the Rescue Coordination Centre (RCC) in Wellington, which is responsible for the provision of search and rescue service in the New Zealand Search and Rescue Region (SRR).

#### *Rescue Co-ordination Centre*

RCC	LOCATION	TELEPHONE	AREA OF RESPONSIBILITY
WELLINGTON	LOWER HUTT	64-4-577 8030	New Zealand SRR

1.1.2 The organisation of the service is based on the utilisation of civil and military facilities. The military facilities are based in New Zealand and New Caledonia and occasionally in Fiji.

1.1.3 The service is provided in accordance with the provisions contained in ICAO Annex 12 — *Search and Rescue*.

### 2 AREA OF RESPONSIBILITY

#### 2.1 General

2.1.1 The RCC is responsible for SAR operations within the New Zealand SRR.

### 3 TYPES OF SERVICE

#### 3.1 General

3.1.1 Details of all rescue units are given in [Table GEN 3.6 - 1](#).

### 3.2 Search and Rescue Units

3.2.1 Search and Rescue Air Units, aircraft, capabilities and equipment are shown in [Table GEN 3.6 - 1](#).

**Table GEN 3.6 - 1  
Search and Rescue Units**

NAME	LOCATION	FACILITIES	REMARKS
AUCKLAND	AUCKLAND	P3K, C130H ELR* Marine – RV, RB	

\*On deployment from Auckland

## 4 SAR AGREEMENTS

### 4.1 General

4.1.1 Nil.

## 5 CONDITIONS OF AVAILABILITY

### 5.1 General

5.1.1 All services listed in [Table GEN 3.6 - 1](#) are continuously available.

## **6 PROCEDURES AND SIGNALS USED**

### **6.1 Procedures and Signals Used by Aircraft**

6.1.1 Procedures for pilots-in-command observing an accident or intercepting a distress call and/or message are outlined in ICAO Annex 12, Chapter 5.

### **6.2 Communications**

6.2.1 Transmission and reception of distress messages within the New Zealand Search and Rescue Region are handled in accordance with ICAO Annex 10, Volume II, Chapter 5, paragraph 5.3.

6.2.2 For communications during search and rescue operations, the codes and abbreviations published in *ICAO Abbreviations and Codes* (Doc 8400) are used.

6.2.3 The carriage of an emergency location transmitter (ELT) is mandatory within the Cook Islands. For this reason, in accordance with ICAO Standards and Recommended Practices, aircraft are required to continuously guard the international emergency frequency 121.5 MHz. This requirement does not apply when aircraft are carrying out communications on other VHF channels, or when airborne equipment limitations or cockpit duties do not permit simultaneous guarding of two or more channels.

6.2.4 The frequency 121.5 MHz is guarded continuously by Faleolo ATS.

### **6.3 Procedures for an Aircraft Requiring SAR Escort**

6.3.1 If the pilot-in-command of an aircraft, while flying over water or a sparsely inhabited area, has any reason to believe that the operating efficiency of the aircraft is impaired, the appropriate Air Traffic Services unit should be notified so that the RCC is forewarned should the position deteriorate. If, at this stage or later, the pilot-in-command considers it advisable, interception and escort by a search and rescue aircraft may be requested.

6.3.2 Disparity in speeds and normal altitudes between some aircraft and SAR aircraft may not permit continuous escort in the accepted sense. The SAR aircraft may turn back along the intended track of the aircraft requiring escort before the interception, so that the latter is catching up with the former. It is most important that radiotelephony (RTF) contact is established between the two aircraft as early as possible and maintained throughout the operation.

## 6.4 RTF Procedures

### **General**

6.4.1 Distress and urgency traffic shall comprise all RTF messages relating to the distress or urgency condition respectively. Distress and urgency conditions are defined as follows:

### **Distress**

6.4.2 A condition of being threatened by serious and/or imminent danger and of requiring immediate assistance.

### **Urgency**

6.4.3 A condition concerning the safety of an aircraft or other vehicle, or of some person on board or within sight, but which does not require immediate assistance.

6.4.4 The RTF distress signal MAYDAY or the urgency signal PAN PAN, preferably spoken three times, shall be used at the commencement of the first distress or urgency communication respectively. The signals should, if it is considered necessary, be used at the commencement of any subsequent communication.

6.4.5 In cases of distress or urgency communications, in general, the transmissions by RTF should be made slowly and distinctly, each word being clearly pronounced to facilitate transcription.

## 6.5 RTF Distress Communications

### **Action by the Aircraft in Distress**

6.5.1 In addition to being preceded by the distress signal MAYDAY the distress message shall:

- (a) be on the air-ground frequency in use at the time; and
- (b) consist of as many as possible of the following elements spoken distinctly and, if possible, in the following order:
  - (i) name of the station addressed (time and circumstances permitting)
  - (ii) identification of the aircraft
  - (iii) nature of the distress condition
  - (iv) intention of the pilot-in-command
  - (v) present position, heading and height



**Notes**

If insufficient time exists for transmission of the entire message, priority is to be given to present position.

The above provisions may be supplemented by the following measures:

- (a) Transmitting the distress message on the emergency frequency 121.5 MHz or another aeronautical mobile frequency likely to be heard in the area.
- (b) Transmitting the distress message on the maritime mobile services RTF calling frequencies.
- (c) Broadcasting the distress message, if time and circumstances make this course preferable.
- (d) Using any means at the pilot's disposal to attract attention and make known the distress condition.
- (e) Any other station taking any means at its disposal to assist an aircraft in distress.
- (f) Any variation on the elements listed in items (a) to (e) when the transmitting station is not itself in distress, provided that such circumstances are clearly stated in the distress message.

The station addressed will normally be that station communicating with the aircraft or in whose area the aircraft is operating.

## **6.6 Imposition of Silence**

6.6.1 The station in distress, or the station in control of distress traffic, shall be permitted to impose silence either on all stations of the mobile service in the area or on any station which interferes with the distress traffic. It shall address these instructions to "all stations" or to one station only, according to the circumstances. In either case it shall use:

- (a) STOP TRANSMITTING
- (b) the RTF distress signal MAYDAY

### **Note**

The use of the above signals shall be reserved for the station in distress and for the station controlling distress traffic.

## **6.7 Action by all Other Stations**

6.7.1 Distress communications have absolute priority over all other communications and a station aware of them shall not transmit on the frequency concerned unless:

- (a) The distress is cancelled or the distress traffic is terminated;
- (b) All distress traffic has been transferred to other frequencies;
- (c) The station controlling communications gives permission; or
- (d) It has itself to render assistance.

6.7.2 Any station which has knowledge of distress traffic, and which cannot itself assist the station in distress, shall nevertheless continue listening to such traffic until it is evident that assistance is being provided.

## **6.8 Termination of Distress Communication and of Silence**

6.8.1 When an aircraft is no longer in distress it shall transmit a message cancelling the distress condition. The distress communication and silence conditions shall be terminated by transmitting a message, including the words "DISTRESS TRAFFIC ENDED", on the frequency or frequencies being used for the distress traffic. This message shall be originated only by the station controlling communications when it is authorised to do so by the appropriate authority.

## 6.9 RTF Urgency Communication

### *Action by an Aircraft Reporting an Urgency Condition*

6.9.1 In addition to being preceded by the urgency signal PAN PAN the urgency signal shall:

- (a) be on the air-ground frequency in use at the time; and
- (b) consist of as many as required of the following elements spoken distinctly and, if possible, in the following order:
  - (i) name of the station addressed
  - (ii) identification of the aircraft
  - (iii) nature of the urgency condition
  - (iv) intention of the pilot-in-command
  - (v) present position, heading and height
  - (vi) any other useful information

### **Notes**

The above provisions may be supplemented by the following measures:

- (a) Transmitting the urgency message on the emergency frequency 121.5 MHz or another aeronautical mobile frequency, if considered necessary or desirable.
- (b) Transmitting the urgency message on the maritime mobile service RTF calling frequencies.
- (c) Broadcasting the urgency message, if time and circumstances make this course preferable.
- (d) Any variation on the elements listed in items (b) (i) to (vi) when the transmitting station is not itself in an urgency condition, provided that such circumstances are clearly stated in the urgency message.

The station addressed will normally be that station communicating with the aircraft or in whose area the aircraft is operating.

**6.10 Action by all Other Stations**

6.10.1 Urgency communications have priority over all other communications except distress. All stations shall take care not to interfere with transmissions of urgency traffic.

**6.11 Procedures for a Pilot-in-Command Observing a Distress Incident**

6.11.1 When a pilot-in-command observes that either another aircraft or a surface craft is in distress, unless the pilot is unable, or, in the circumstances of the case, considers it unreasonable or unnecessary, they shall:

- (a) Keep the craft in distress in sight until no longer necessary or until no longer able to remain in the vicinity of the distress craft.
- (b) If position is not known with certainty, take such action as will facilitate the determination of it.
- (c) Report to the RCC or aeronautical station as much of the following information as is possible:
  - (i) type of aircraft in distress, its identification and condition
  - (ii) its position, expressed in geographical coordinates or in distance and true bearing from a distinctive landmark
  - (iii) time of observation (in UTC)
  - (iv) number of persons observed
  - (v) whether the persons have been seen to abandon the craft in distress
  - (vi) number of persons observed to be afloat, and
  - (vii) apparent physical condition of survivors
- (d) Act as instructed by the RCC.

6.11.2 If the pilot-in-command of the first aircraft to reach the place of the accident is unable to establish communication with an aeronautical station, that pilot should take charge of the activities of all other aircraft that arrive until handing control over to the aircraft best able to provide communication.

## **6.12 Procedures for a Pilot-in-Command Intercepting a Distress Message**

6.12.1 Whenever a distress message is intercepted on radio by a pilot-in-command of an aircraft, other than a search aircraft, the pilot shall:

- (a) If possible take a bearing on the transmission
- (b) Listen out and if no acknowledgement is heard, acknowledge receipt and relay the message to the appropriate aeronautical station by any means available
- (c) If necessary, exercise control of communications until the aeronautical station is able to take control
- (d) Plot the position of the craft in distress if given
- (e) At the pilot's discretion, while awaiting instructions, proceed to the position given in the distress message

## **6.13 Non-Radio Distress and Urgency Signals**

6.13.1 In a distress situation, if radio is not available, any of the following distress signals may be used as an alternative means of obtaining assistance:

- (a) Rockets or shells throwing red lights, fired one at a time or at short intervals.
- (b) A parachute flare showing a red light.

6.13.2 In an urgency situation, if radio is not available, the following urgency signals may be used as an alternative:

- (a) a succession of green pyrotechnic lights, or
- (b) a succession of green flashes with signal apparatus.

6.13.3 In addition to the above, the following signals used either together or separately, mean that an aircraft wishes to notify difficulties which compel it to land without requiring immediate assistance:

- (a) the repeated switching on and off of the landing lights, or
- (b) the repeated switching on and off of the navigation lights, or
- (c) a succession of white pyrotechnic lights.

6.13.4 If a forced landing has been made, every effort should be made to attract attention using the "Ground – Air Visual Signal Code" shown in [Table GEN 3.6 - 2](#).

**Table GEN 3.6 - 2**  
**Ground/Air Visual Signal Codes**

NO	MESSAGE	CODE SYMBOL
1	Require assistance	V
2	Require medical assistance	X
3	No or negative	N
4	Yes or affirmative	Y
5	Proceeding in this direction	↑

***Instructions for use***

- (a) Make signals not less than 8ft (2.5m).
- (b) Take care to lay out signals exactly as shown.
- (c) Provide as much colour contrast as possible between signals and background.
- (d) Make every effort to attract attention by other means such as radio, flares, smoke, reflected light.

## **6.14 Procedure for Directing a Surface Craft to a Distress Incident**

6.14.1 When it is necessary for a pilot-in-command to direct surface craft to the place where an aircraft or a surface craft is in distress, the pilot should do so by transmitting precise instructions by any means available. If such precise instructions cannot be transmitted, they should be given by carrying out the following procedure:

- (a) Circle the surface craft at least once;
- (b) Cross the projected course of the surface craft close ahead at low altitude;
  - (i) rocking the aircraft, or
  - (ii) opening and closing the throttle, or
  - (iii) changing the propeller pitch.
- (c) Head in the direction in which the surface craft is to be directed.
- (d) Repeat these procedures until the surface craft acknowledges.

### **Note**

Due to the high noise level on board surface craft, sound signals may be less effective than the visual signals and are regarded as an alternative means of attracting attention.

**6.15 Current Maritime Signalling Procedures**

6.15.1 For acknowledging receipt of signals:

- (a) Hoisting of the "Code Pennant" (vertical red and white stripes) close up (meaning understood)
- (b) Flashing of a succession of "T's" by signal lamp in the Morse Code
- (c) Changing of heading

6.15.2 For indicating inability to comply:

- (a) Hoisting of the international flag "N" (blue/white checks, 16 squares)
- (b) Flashing a succession of "N's" in the Morse Code

**6.16 Procedure to Signify that Assistance from a Surface Craft is No Longer Required**

6.16.1 When assistance of a surface craft is no longer required an aircraft should cross the wake of the surface craft close astern at low altitude:

- (a) rocking the aircraft, or
- (b) opening and closing the throttle, or
- (c) changing the propeller pitch

**Note**

Due to the high noise level on board surface craft, sound signals may be less effective than the visual signals and are regarded as alternative means of attracting attention.

**7 VISUAL INSPECTIONS BY ATS UNIT****7.1 General**

7.1.1 In certain situations the pilot in an emergency may request an ATS unit to conduct a visual inspection of the aircraft in-flight, e.g. undercarriage malfunction. Where available, ATS units will seek assistance from the operator's engineering staff or its handling agents for expert advice to the pilot. In the absence of such assistance ATS personnel will report their visual observations to the pilot. Such reports are for information only and do not constitute authoritative advice in any form whatsoever.



## 8 EMERGENCY LOCATOR TRANSMITTERS (ELT)

### 8.1 General

8.1.1 The essence of a successful search and rescue operation is the speed with which it can be accomplished. It must be presumed that in each incident there are survivors who need help and whose chances of survival diminish with every passing minute. Emergency location beacons facilitate rapid location of a distress incident by day and night and their carriage is compulsory in Cook Islands registered aircraft. These electronic, battery operated transmitters emit a distinctive downward swept audio tone on 121.5 MHz, 243 MHz or 406 MHz, depending on whether they are an Emergency Location Transmitter — Aircraft (ELT) or an Emergency Position Indicating Radio Beacon (EPIRB).

### 8.2 Emergency Activation

8.2.1 To prevent valuable air search time being wasted it is imperative that:

- (a) Any emergency beacon that is not automatically activated is switched on as soon as possible after any emergency and **left on until rescue**. THE SWITCHING ON AND OFF OF ANY BEACON MAY WELL VOID A RADIO SEARCH PROCEDURE.
- (b) In the event of all survivors leaving the crash scene the emergency beacon must be carried with them. The prime objective of the search is for the survivors, not the wreckage.

### 8.3 Emergency Location Transmitter Reporting Procedures

8.3.1 On receiving an ELT signal, a pilot shall report the following information to the nearest ATS unit:

- (a) aircraft position and time the signal was first heard
- (b) aircraft position and time the signal was last heard
- (c) aircraft position at maximum signal strength
- (d) aircraft level, strength and frequency of emergency signal (121.5 MHz/243 MHz)

## 8.4 ELT Testing

8.4.1 Operational testing of beacons should, if possible, be carried out only in shielded areas under controlled conditions. False signals on the distress frequencies can interfere with actual distress transmissions as well as decrease the degree of urgency that should be attached to such signals. Aircraft operational testing is authorised on 121.5 MHz or 243 MHz as follows:

- (a) Tests should be no longer than three audio sweeps.
- (b) Tests shall be conducted **ONLY** within the time period made up of the first five minutes after every hour. Emergency tests outside of this time shall be coordinated with the nearest ATS unit. Airborne ELT tests are **NOT** permitted.

## 8.5 Inadvertent Activation

8.5.1 Inadvertent activation of emergency locator beacons has occurred on numerous occasions in the Cook Islands. It can occur as a result of aerobatics, hard landings or accidental activation during aircraft servicing. To prevent transmissions due to inadvertent activation pilots-in-command shall:

- (a) prior to engine shut down at the end of each flight, tune the aircraft receiver to 121.5 MHz (or 243 MHz if applicable) and listen for ELT signals; and
- (b) if an ELT is heard, check the aircraft's beacon to determine whether it is the one in operation. If it is found that it has been activated, switch off immediately and report the occurrence to the nearest ATS unit.

### **Note**

Maintenance may be required before an automatic activation is returned to the armed position.

Reminders to ensure that the ELTA is switched off at the end of flights should be placed on the checklist or placards. Use of other effective reminders is encouraged.

To prevent inadvertent activation, batteries must be removed before a beacon is dispatched for maintenance.

Any case where inadvertent activation of an emergency location beacon is detected must be reported immediately to the nearest ATS unit in order that any SAR action, commenced as a result of the beacon transmissions, may be terminated.

## **9 AERODROME EMERGENCIES**

### **9.1 Aerodrome Emergency Plan**

9.1.1 The object of an Aerodrome Emergency Plan is to prepare an aerodrome to cope with an emergency occurring on or within the vicinity of the aerodrome. The plan sets out the procedures for coordinating the response of different aerodrome services and those agencies in the surrounding community that could be of assistance in an emergency.

9.1.2 Examples of the type of emergencies are:

- (a) aircraft malfunctions
- (b) sabotage, including bomb threats
- (c) unlawfully seized aircraft
- (d) dangerous goods occurrences
- (e) building fires and natural disasters

9.1.3 An Aerodrome Emergency Plan exists at Rarotonga International Airport.

## **9.2 Procedures to Activate Aerodrome Emergency Services**

9.2.1 The ATS unit on the aerodrome is responsible for alerting the emergency services, following a request from a pilot or when an aircraft is considered to be in any of the following emergency phases:

### ***Local Standby Phase***

9.2.2 When an aircraft approaching the aerodrome is known, or is suspected, to have developed some defect, but the trouble is not such as would normally prevent effecting a safe landing.

9.2.3 Declaration of the LOCAL STANDBY PHASE will bring the aerodrome-based emergency services to a state of readiness but, in general, although off-aerodrome components may be notified, they will remain at their posts.

### ***Full Emergency Phase***

9.2.4 When an aircraft approaching the airport is, or is suspected to be, in such trouble that there is danger of an accident.

9.2.5 Declaration of the FULL EMERGENCY PHASE will bring all facilities, both on the aerodrome and in the city or community, such as medical and ambulance services, Police and Fire Services, to a rendezvous point on the aerodrome. It will also alert the hospital to prepare for possible reception of injured and for road traffic control to be instituted along the route between the city and aerodrome to clear the way for emergency vehicles.

### ***Aircraft Accident Phase***

9.2.6 AIRCRAFT ACCIDENT ON AIRPORT or AIRCRAFT ACCIDENT OFF AIRPORT when an aircraft accident has occurred on or in the vicinity of the airport.

9.2.7 Declaration of the AIRCRAFT ACCIDENT PHASE will bring all facilities into immediate action.

9.2.8 When an emergency occurs in-flight and adequate communications exist, the pilot-in-command is responsible for advising the ATS unit accordingly and for nominating the desired state of readiness of the aerodrome emergency services.

9.2.9 If adequate communications with aircraft do not exist, the ATS specialist will assess the situation and bring the aerodrome emergency services to the state of readiness considered appropriate.

# **GEN 4 CHARGES FOR AERODROMES/ HELIPORTS AND AIR NAVIGATION SERVICES**



## GEN 4.1 AERODROME CHARGES

### 1 AERODROME CHARGES

#### 1.1 General

1.1.1 Landing charges are generally calculated on the aircraft's MCTOW in accordance with its Certificate of Airworthiness.

1.1.2 The Cook Islands Airport Authority prescribes the charges for the landing and parking of aircraft. These charges are detailed in [TABLE 4.1 -1](#).

1.1.3 Details including any estimated charges for all services are available from Finance section of the Cook Islands Airport Authority.

TEL +682 25890 ext 232  
 FAX +682 21890  
 Email [florence@airport.gov.ck](mailto:florence@airport.gov.ck)

**Table GEN 4.1 - 1  
 Landing Charges**

CHARGES	EFFECTIVE DATES			
	1 JUL 16	1 JUL 17	1 JUL 18	1 JUL 19
<b>Landing charges</b>				
Under 40,000kg \$/tonne MCTOW	\$13.33	\$13.59	\$13.86	\$14.14
Over 40,000kg \$/tonne MCTOW	\$20.89	\$21.31	\$21.73	\$22.17
<b>Air Traffic Service charge</b>				
Domestic — \$/tonne	\$1.22	\$1.83	\$2.44	\$2.44
International — \$/tonne	\$2.44	\$4.87	\$4.87	\$4.87
International Passenger Terminal charges per arriving and departing passenger	\$4.28	\$5.68	\$7.08	\$7.08
Aircraft Parking charges	1–4 hours no charge; each hour thereafter \$10 per hour			
Local general aviation flights (Air Rarotonga)	\$2,800 per year			
Airfield lighting charges	\$35.18 per landing or take-off			
ATC Extension coverage outside NOTAM hours of watch	100.00 per hour			

## **2 EXEMPTIONS AND REDUCTIONS**

### **2.1 Exemptions**

2.1.1 The following are exempt from the passenger service charge:

- (a) Diplomatic aircraft;
- (b) Test or training flights;
- (c) Aircraft engaged in flights of a humanitarian nature, including search and rescue flights;
- (d) Emergency landings.

### **2.2 Reductions**

2.2.1 Nil.

### **2.3 Surcharges**

2.3.1 Nil.

### **2.4 Cargo**

2.4.1 Nil.

## **3 METHODS OF PAYMENT**

### **3.1 General**

3.1.1 Cash payments should be made before departure for non-scheduled aircraft at the main office of the Cook Islands Airport Authority.



---

## **GEN 4.2 AIR NAVIGATION CHARGES**

### **1 CHARGES**

#### **1.1 General**

1.1.1 Nil.

### **2 EXEMPTIONS/REDUCTIONS**

#### **2.1 General**

2.1.1 Nil.

### **3 METHODS OF PAYMENT**

#### **3.1 General**

3.1.1 Nil.

# **Intentionally Blank**

**ENR 0.6 TABLE OF CONTENTS — ENR**

	<u>Page No.</u>
<b>ENR 0.6 TABLE OF CONTENTS — ENR .....</b>	<b>ENR 0.6 - 1</b>
<b>ENR 1 GENERAL RULES AND PROCEDURES .....</b>	<b>ENR 1 - 1</b>
<b>ENR 1.1 GENERAL RULES AND PROCEDURES .....</b>	<b>ENR 1.1 - 1</b>
1 General Rules .....	ENR 1.1 - 1
1.1 Introduction .....	ENR 1.1 - 1
2 ATC Separation .....	ENR 1.1 - 1
2.1 Provision of ATC Separation .....	ENR 1.1 - 1
2.2 Vertical Separation .....	ENR 1.1 - 3
2.3 Horizontal Separation .....	ENR 1.1 - 3
2.4 Longitudinal Separation .....	ENR 1.1 - 4
2.5 Lateral Separation. ....	ENR 1.1 - 4
2.6 Geographical Separation .....	ENR 1.1 - 5
2.7 Use of DME for Separation Purposes .....	ENR 1.1 - 5
3 Reduction in Separation Minima .....	ENR 1.1 - 5
3.1 Flights Maintaining Own Separation in VMC in Class D Airspace .....	ENR 1.1 - 5
3.2 Visual Separation .....	ENR 1.1 - 6
3.3 Composite Visual Separation .....	ENR 1.1 - 7
4 Priorities .....	ENR 1.1 - 8
4.1 General .....	ENR 1.1 - 8
5 Minimum Flight Altitudes .....	ENR 1.1 - 10
5.1 VFR .....	ENR 1.1 - 10
5.2 IFR .....	ENR 1.1 - 10
<b>ENR 1.2 VISUAL FLIGHT RULES .....</b>	<b>ENR 1.2 - 1</b>
1 General .....	ENR 1.2 - 1
1.1 Pilot Responsibilities .....	ENR 1.2 - 1
1.2 Limitations .....	ENR 1.2 - 1
1.3 Air Traffic Control Service .....	ENR 1.2 - 1
1.4 Change of Flight Rules .....	ENR 1.2 - 1
1.5 Parachute Operations .....	ENR 1.2 - 1
2 Position and Altitude Reporting Requirements .....	ENR 1.2 - 2
2.1 VFR Flights Entering Class D Airspace, With ATC in Attendance .....	ENR 1.2 - 2
2.2 VFR Flights Entering an Aerodrome Traffic Circuit .....	ENR 1.2 - 2
2.3 Frequency Changes .....	ENR 1.2 - 2

**Page No.**

3	Clearance From Cloud and Visibility Requirements ...	ENR 1.2 - 3
3.1	General .....	ENR 1.2 - 3
	<i>Table ENR 1.2-1</i>	
	<i>VFR Meteorological Minima .....</i>	<i>ENR 1.2 - 3</i>
4	Position and Altitude Reporting Requirements .....	ENR 1.2 - 5
4.1	General .....	ENR 1.2 - 5
4.2	Enroute VFR Flights .....	ENR 1.2 - 5
5	Aerodrome MET Minima for Operations in CTR .....	ENR 1.2 - 6
5.1	General .....	ENR 1.2 - 6
5.2	MET Minima for Operation as VFR Flight by Night .....	ENR 1.2 - 6
6	Special VFR Flights (SVFR) .....	ENR 1.2 - 7
6.1	Aerodrome Meteorological Minima .....	ENR 1.2 - 7
	<i>Table ENR 1.2-2</i>	
	<i>VFR Aerodrome Meteorological Minima .....</i>	<i>ENR 1.2 - 7</i>
6.2	General .....	ENR 1.2 - 7
<b>ENR 1.3</b>	<b>INSTRUMENT FLIGHT RULES .....</b>	<b>ENR 1.3 - 1</b>
1	Rules applicable to all IFR flights .....	ENR 1.3 - 1
1.1	Classification of IFR Flights .....	ENR 1.3 - 1
1.2	Responsibility of Pilot-in-Command .....	ENR 1.3 - 1
1.3	Routing to Avoid Hazardous MET Conditions ....	ENR 1.3 - 2
1.4	Aircraft Equipment .....	ENR 1.3 - 2
1.5	Change from IFR Flight to VFR Flight .....	ENR 1.3 - 2
2	Rules Applicable to IFR Flights Within Controlled Airspace .....	ENR 1.3 - 3
2.1	General .....	ENR 1.3 - 3
3	Rules Applicable to IFR Flights Outside Controlled Airspace .....	ENR 1.3 - 3
3.1	Cruising Levels .....	ENR 1.3 - 3
4	Communications, Position Reports and Traffic Information Outside Controlled Airspace .....	ENR 1.3 - 4
4.1	General .....	ENR 1.3 - 4
4.2	Position Reports .....	ENR 1.3 - 4
4.3	Position Reporting at AFIS Aerodromes .....	ENR 1.3 - 5
4.4	Position and Altitude Reporting — IFR Flights Entering an Aerodrome Traffic Circuit at Unattended Aerodromes .....	ENR 1.3 - 5
4.5	Separation of IFR Flights Outside Controlled Airspace .....	ENR 1.3 - 5
4.6	Position and Altitude Reporting Enroute .....	ENR 1.3 - 6

**Page No.**

<b>ENR 1.4</b>	<b>ATS AIRSPACE CLASSIFICATION .....</b>	<b>ENR 1.4 - 1</b>
1	Classification of Airspaces .....	ENR 1.4 - 1
1.1	General .....	ENR 1.4 - 1
1.2	Class C — CTA .....	ENR 1.4 - 1
1.3	Class D — CTR .....	ENR 1.4 - 1
1.4	Class G — Uncontrolled Airspace .....	ENR 1.4 - 1
	<i>Table ENR 1.4-1</i>	
	<i>Airspace Classification Table .....</i>	<i>ENR 1.4 - 3</i>
<b>ENR 1.5</b>	<b>HOLDING, APPROACH AND DEPARTURE PROCEDURES .....</b>	<b>ENR 1.5 - 1</b>
1	Holding .....	ENR 1.5 - 1
1.1	General .....	ENR 1.5 - 1
	<i>Table ENR 1.5-1</i>	
	<i>Maximum IAS for Holding Patterns .....</i>	<i>ENR 1.5 - 2</i>
2	Standard Holding Pattern .....	ENR 1.5 - 3
2.1	General .....	ENR 1.5 - 3
	<i>Figure ENR 1.5-1</i>	
	<i>Standard Holding Pattern .....</i>	<i>ENR 1.5 - 3</i>
2.2	Entry Procedures .....	ENR 1.5 - 4
	<i>Figure ENR 1.5-2</i>	
	<i>Holding Pattern Entry Sectors .....</i>	<i>ENR 1.5 - 4</i>
2.3	Holding Procedures and Time — Still Air Conditions .....	ENR 1.5 - 6
2.4	Holding Procedures and Timing — Wind Effect ..	ENR 1.5 - 6
2.5	Holding Procedures and Timing — Departing the Pattern .....	ENR 1.5 - 6
2.6	Obstacle Clearance — Holding Area .....	ENR 1.5 - 7
2.7	Obstacle Clearance — Buffer Area .....	ENR 1.5 - 7
2.8	Obstacle Clearance — Minimum Holding Altitude .....	ENR 1.5 - 7
2.9	Precautionary Holding .....	ENR 1.5 - 8
3	Arriving flights .....	ENR 1.5 - 9
3.1	General .....	ENR 1.5 - 9
3.2	Aircraft Speed Restrictions .....	ENR 1.5 - 9
4	Approach Procedures .....	ENR 1.5 - 10
4.1	The Instrument Approach Procedure .....	ENR 1.5 - 10
4.2	Instrument Approach Fixes .....	ENR 1.5 - 10
4.3	Instrument Approach Segments .....	ENR 1.5 - 10
	<i>Figure ENR 1.5-3</i>	
	<i>Tear-drop Approach Segments .....</i>	<i>ENR 1.5 - 11</i>
4.4	Procedure Speeds .....	ENR 1.5 - 12
	<i>Table ENR 1.5-2</i>	
	<i>Speeds for Procedure Calculations .....</i>	<i>ENR 1.5 - 12</i>
4.5	Minima .....	ENR 1.5 - 13

**Page No.**

4.6	Application of Minima .....	ENR 1.5 - 14
4.7	Aircraft Approach Categories .....	ENR 1.5 - 15
<i>Table ENR 1.5-3</i>		
	<i>Aircraft Category</i> .....	<i>ENR 1.5 - 15</i>
4.8	Landing minima format .....	ENR 1.5 - 16
4.9	Instrument Approach Procedure Timing .....	ENR 1.5 - 16
<i>Table ENR 1.5-4</i>		
	<i>Instrument Approach Procedure — Timing Adjustment</i> .	<i>ENR 1.5 - 16</i>
4.10	Position Reporting During Instrument Approach at a Controlled Aerodrome .....	ENR 1.5 - 17
4.11	Visual Approach — Controlled Airspace .....	ENR 1.5 - 17
4.12	Visual Approach — Uncontrolled Airspace .....	ENR 1.5 - 18
4.13	Visual Reference — Descent Below Minimum Altitude or Minimum Descent Altitude .....	ENR 1.5 - 19
4.14	Visual Segment Surface (VSS) .....	ENR 1.5 - 19
4.15	Unattended Aerodromes — QNH Source .....	ENR 1.5 - 19
4.16	IFR Arrival Procedures — Unattended Aerodromes .....	ENR 1.5 - 20
4.17	RNAV/Baro-VNAV Approach Procedures .....	ENR 1.5 - 21
5	Departing Flights .....	ENR 1.5 - 22
5.1	General .....	ENR 1.5 - 22
5.2	Standard Instrument Departure (SID) .....	ENR 1.5 - 23
5.3	IFR Alternate Aerodrome Minima .....	ENR 1.5 - 23
<b>ENR 1.6</b>	<b>RADAR SERVICES AND PROCEDURES .....</b>	<b>ENR 1.6 - 1</b>
1	Services .....	ENR 1.6 - 1
1.1	General .....	ENR 1.6 - 1
<b>ENR 1.7</b>	<b>ALTIMETER SETTING PROCEDURES .....</b>	<b>ENR 1.7 - 1</b>
1	Introduction .....	ENR 1.7 - 1
1.1	General .....	ENR 1.7 - 1
2	Basic Altimeter Setting Procedures .....	ENR 1.7 - 1
2.1	General .....	ENR 1.7 - 1
<i>Table ENR 1.7-1</i>		
	<i>Flight Level and Altimeter Indications</i> .....	<i>ENR 1.7 - 2</i>
2.2	Take-off and Climb .....	ENR 1.7 - 3
2.3	Vertical Separation — Enroute .....	ENR 1.7 - 3
2.4	Approach and Landing .....	ENR 1.7 - 3
2.5	QFE Altimeter Settings .....	ENR 1.7 - 3
2.6	Missed Approach .....	ENR 1.7 - 3
3	Description of Area QNH Zones .....	ENR 1.7 - 4
3.1	General .....	ENR 1.7 - 4
<i>Table ENR 1.7-2</i>		
	<i>Area QNH Zones</i> .....	<i>ENR 1.7 - 4</i>

**Page No.**

4	Procedures Applicable to Operators (Including Pilots) .....	ENR 1.7 - 4
4.1	Flight Planning .....	ENR 1.7 - 4
5	Table of Cruising Levels .....	ENR 1.7 - 5
5.1	General .....	ENR 1.7 - 5
	<i>Table ENR 1.7-3</i>	
	<i>Table of Cruising Levels</i> .....	ENR 1.7 - 5
<b>ENR 1.8</b>	<b>REGIONAL SUPPLEMENTARY PROCEDURES</b> ....	<b>ENR 1.8 - 1</b>
1	Introduction .....	ENR 1.8 - 1
1.1	General .....	ENR 1.8 - 1
<b>ENR 1.9</b>	<b>AIR TRAFFIC FLOW MANAGEMENT (ATFM)</b> ....	<b>ENR 1.9 - 1</b>
1	Introduction .....	ENR 1.9 - 1
1.1	General .....	ENR 1.9 - 1
<b>ENR 1.10</b>	<b>FLIGHT PLANNING (RESTRICTION, LIMITATION OR ADVISORY INFORMATION)</b> .....	<b>ENR 1.10 - 1</b>
1	Procedures for the Submission of a Flight Plan ....	ENR 1.10 - 1
1.1	General .....	ENR 1.10 - 1
1.2	Time of Submission .....	ENR 1.10 - 1
1.3	Place of Submission .....	ENR 1.10 - 1
1.4	Contents and Form of a Flight Plan .....	ENR 1.10 - 1
1.5	Adherence to ATS Route Structure .....	ENR 1.10 - 1
1.6	Completing the ICAO Flight Plan Form .....	ENR 1.10 - 2
2	Repetitive Flight Plan System .....	ENR 1.10 - 15
2.1	General .....	ENR 1.10 - 15
3	Changes to the Submitted Flight Plan .....	ENR 1.10 - 15
3.1	General .....	ENR 1.10 - 15
4	Arrival Report (Terminating a Flight Plan) .....	ENR 1.10 - 17
4.1	General .....	ENR 1.10 - 17
<b>ENR 1.11</b>	<b>ADDRESSING OF FLIGHT PLAN MESSAGES</b> ....	<b>ENR 1.11 - 1</b>
1	General .....	ENR 1.11 - 1
1.1	Flight Movement Messages .....	ENR 1.11 - 1
	<i>Table ENR 1.11-1</i>	
	<i>Flight Movement Messages</i> .....	ENR 1.11 - 1
<b>ENR 1.12</b>	<b>INTERCEPTION OF CIVIL AIRCRAFT</b> .....	<b>ENR 1.12 - 1</b>
1	Visual Signals For Use by Intercepting and Intercepted Aircraft .....	ENR 1.12 - 1
1.1	General .....	ENR 1.12 - 1
2	Signals Initiated by Intercepting Aircraft and Responses by Intercepted Aircraft .....	ENR 1.12 - 2
2.1	General .....	ENR 1.12 - 2
	<i>Table ENR 1.12-1</i>	
	<i>Signals Initiated by Intercepting Aircraft and Responses by Intercepted Aircraft</i> .....	ENR 1.12 - 2

**Page No.**

<b>ENR 1.13 UNLAWFUL INTERFERENCE .....</b>	<b>ENR 1.13 - 1</b>
1 General .....	ENR 1.13 - 1
1.1 Introduction .....	ENR 1.13 - 1
2 Procedures .....	ENR 1.13 - 1
2.1 Introduction .....	ENR 1.13 - 1
<b>ENR 1.14 AIR TRAFFIC INCIDENTS .....</b>	<b>ENR 1.14 - 1</b>
1 Air Safety Incidents .....	ENR 1.14 - 1
1.1 General .....	ENR 1.14 - 1
2 Aviation Safety Report .....	ENR 1.14 - 1
2.1 General .....	ENR 1.14 - 1
3 Facility Malfunction Reporting .....	ENR 1.14 - 2
3.1 General .....	ENR 1.14 - 2
<b>ENR 1.15 EMERGENCY PROCEDURES .....</b>	<b>ENR 1.15 - 1</b>
1 Distress .....	ENR 1.15 - 1
1.1 Definition .....	ENR 1.15 - 1
1.2 Transmission of MAYDAY Message .....	ENR 1.15 - 1
1.3 Content of MAYDAY Message .....	ENR 1.15 - 1
2 Urgency .....	ENR 1.15 - 2
2.1 Definition .....	ENR 1.15 - 2
2.2 Transmission of PAN PAN Message .....	ENR 1.15 - 2
2.3 Content of PAN PAN Message .....	ENR 1.15 - 2
3 Communications Failure .....	ENR 1.15 - 3
3.1 ATS Communications Failure .....	ENR 1.15 - 3
3.2 IFR Communications Failure — General .....	ENR 1.15 - 3
3.3 IFR Communications Failure — VMC and Certain of Maintaining VMC .....	ENR 1.15 - 3
3.4 IFR Communications Failure — IMC or Uncertain of Maintaining VMC .....	ENR 1.15 - 4
4 VFR Communications Failure .....	ENR 1.15 - 6
4.1 ATS Communications Failure .....	ENR 1.15 - 6
4.2 VFR Communications Failure .....	ENR 1.15 - 6
5 Speechless Technique Using Unmodulated Transmission .....	ENR 1.15 - 7
5.1 General .....	ENR 1.15 - 7
6 Aerodrome Emergencies .....	ENR 1.15 - 8
6.1 Aerodrome Emergency Plan .....	ENR 1.15 - 8
6.2 Procedures to Activate Aerodrome Emergency Services .....	ENR 1.15 - 8



**Page No.**

7	Traffic Information Broadcasts By Aircraft (TIBA) .....	ENR 1.15 - 9
7.1	General .....	ENR 1.15 - 9
7.2	Degradation of the ATS System .....	ENR 1.15 - 9
7.3	Introduction and Applicability of TIBA .....	ENR 1.15 - 9
7.4	VHF RTF Frequency to be Used for TIBA .....	ENR 1.15 - 10
7.5	TIBA Listening Watch .....	ENR 1.15 - 10
7.6	Timing of TIBA .....	ENR 1.15 - 10
7.7	Content of TIBA .....	ENR 1.15 - 10
7.8	Acknowledgement of TIBA .....	ENR 1.15 - 10
7.9	Changes of Cruising Level Under TIBA .....	ENR 1.15 - 11
7.10	Collision Avoidance Under TIBA .....	ENR 1.15 - 11
7.11	Normal Position Reporting Procedures Under TIBA .....	ENR 1.15 - 11

*Table ENR 1.15-1*

*Information Required in TIBA .....* ENR 1.15-12

## **ENR 2 AIR TRAFFIC SERVICES AIRSPACE ..... ENR 2 - 1**

### **ENR 2.1 CTR, TMA, CTA ..... ENR 2.1 - 1**

1	Area of Responsibility .....	ENR 2.1 - 1
1.1	General .....	ENR 2.1 - 1

*Table ENR 2.1-1*

*Air Traffic Services and Airspace .....* ENR 2.1 - 2

2	Air Traffic Services .....	ENR 2.1 - 4
2.1	General .....	ENR 2.1 - 4
3	Service Provided .....	ENR 2.1 - 4
3.1	General .....	ENR 2.1 - 4
3.2	Air Traffic Control (ATC) .....	ENR 2.1 - 5
3.3	Flight Information Service .....	ENR 2.1 - 5
3.4	Aerodrome Flight Information Service .....	ENR 2.1 - 6

### **ENR 2.2 OTHER REGULATED AIRSPACE ..... ENR 2.2 - 1**

1	Other Airspace .....	ENR 2.2 - 1
1.1	General .....	ENR 2.2 - 1

## **ENR 3 ATS ROUTES ..... ENR 3 - 1**

### **ENR 3.1 LOWER ATS ROUTES ..... ENR 3.1 - 1**

1	Introduction .....	ENR 3.1 - 1
1.1	General .....	ENR 3.1 - 1
1.2	Reporting Points .....	ENR 3.1 - 1
1.3	Adherence to Track .....	ENR 3.1 - 1

	<u>Page No.</u>
<b>ENR 3.2 UPPER ATS ROUTES .....</b>	<b>ENR 3.2 - 1</b>
1 Introduction .....	ENR 3.2 - 1
1.1 General .....	ENR 3.2 - 1
1.2 Reporting Points .....	ENR 3.2 - 1
1.3 Adherence to Track .....	ENR 3.2 - 1
<b>ENR 3.3 AREA NAVIGATION ROUTES .....</b>	<b>ENR 3.3 - 1</b>
1 Introduction .....	ENR 3.3 - 1
1.1 General .....	ENR 3.3 - 1
<b>ENR 3.4 HELICOPTER ROUTES .....</b>	<b>ENR 3.4 - 1</b>
1 Introduction .....	ENR 3.4 - 1
1.1 General .....	ENR 3.4 - 1
<b>ENR 3.5 OTHER ROUTES .....</b>	<b>ENR 3.5 - 1</b>
1 Introduction .....	ENR 3.5 - 1
1.1 General .....	ENR 3.5 - 1
<b>ENR 3.6 ENROUTE HOLDING .....</b>	<b>ENR 3.6 - 1</b>
1 Introduction .....	ENR 3.6 - 1
1.1 General .....	ENR 3.6 - 1
<b>ENR 4 RADIO NAVIGATION AIDS/SYSTEMS .....</b>	<b>ENR 4 - 1</b>
<b>ENR 4.1 RADIO NAVIGATION AIDS — ENROUTE .....</b>	<b>ENR 4.1 - 1</b>
1 Radio Navigation Aids .....	ENR 4.1 - 1
1.1 General .....	ENR 4.1 - 1
<i>Table ENR 4.1-1</i>	
<i>Radio Navigation Aids — Enroute .....</i>	<i>ENR 4.1 - 1</i>
<b>ENR 4.2 SPECIAL NAVIGATION SYSTEMS .....</b>	<b>ENR 4.2 - 1</b>
1 Introduction .....	ENR 4.2 - 1
1.1 General .....	ENR 4.2 - 1
<b>ENR 4.3 NAME-CODE DESIGNATORS FOR SIGNIFICANT POINTS .....</b>	<b>ENR 4.3 - 1</b>
1 Introduction .....	ENR 4.3 - 1
1.1 General .....	ENR 4.3 - 1
<b>ENR 4.4 AERONAUTICAL GROUND LIGHTS — ENROUTE .....</b>	<b>ENR 4.4 - 1</b>
1 Introduction .....	ENR 4.4 - 1
1.1 General .....	ENR 4.4 - 1
<i>Table ENR 4.4-1</i>	
<i>Aeronautical Ground Lights — Enroute .....</i>	<i>ENR 4.4 - 1</i>

**Page No.**

<b>ENR 5</b>	<b>NAVIGATION WARNINGS .....</b>	<b>ENR 5 - 1</b>
<b>ENR 5.1</b>	<b>PROHIBITED, RESTRICTED AND DANGER AREAS .....</b>	<b>ENR 5.1 - 1</b>
1	Definitions .....	ENR 5.1 - 1
1.1	General .....	ENR 5.1 - 1
1.2	Prohibited Area .....	ENR 5.1 - 1
1.3	Restricted Area .....	ENR 5.1 - 1
1.4	Danger Area .....	ENR 5.1 - 2
1.5	Zone Identification .....	ENR 5.1 - 2
1.6	Designated Prohibited, Restricted and Danger Areas .....	ENR 5.1 - 2
<b>ENR 5.2</b>	<b>MILITARY EXERCISE AND TRAINING AREAS ...</b>	<b>ENR 5.2 - 1</b>
1	Introduction .....	ENR 5.2 - 1
1.1	General .....	ENR 5.2 - 1
<b>ENR 5.3</b>	<b>OTHER ACTIVITIES OF A DANGEROUS NATURE .....</b>	<b>ENR 5.3 - 1</b>
1	Low Flying Zones .....	ENR 5.3 - 1
	Table ENR 5.3-1 .....	ENR 5.3 - 1
<b>ENR 5.4</b>	<b>AIR NAVIGATION OBSTACLES — ENROUTE ....</b>	<b>ENR 5.4 - 1</b>
1	Introduction .....	ENR 5.4 - 1
1.1	General .....	ENR 5.4 - 1
<b>ENR 5.5</b>	<b>AERIAL SPORTING AND RECREATIONAL ACTIVITIES .....</b>	<b>ENR 5.5 - 1</b>
1	Introduction .....	ENR 5.5 - 1
1.1	General .....	ENR 5.5 - 1
<b>ENR 5.6</b>	<b>BIRD MIGRATION AND AREAS WITH SENSITIVE FAUNA .....</b>	<b>ENR 5.6 - 1</b>
1	Introduction .....	ENR 5.6 - 1
1.1	General .....	ENR 5.6 - 1
<b>ENR 6</b>	<b>ENROUTE CHARTS .....</b>	<b>ENR 6 - 1</b>
<b>ENR 6.1</b>	<b>ENROUTE CHARTS .....</b>	<b>ENR 6.1 - 1</b>
1	Introduction .....	ENR 6.1 - 1
1.1	General .....	ENR 6.1 - 1
	Domestic Enroute Chart South .....	ENR 6.1 - 3
	Domestic Enroute Chart North .....	ENR 6.1 - 4

# **Intentionally Blank**

# **ENR 1 GENERAL RULES AND PROCEDURES**



## ENR 1.1 GENERAL RULES AND PROCEDURES

### 1 GENERAL RULES

#### 1.1 Introduction

1.1.1 The air traffic rules and procedures applicable to air traffic in Cook Islands territory conform to Annexes 2 and 11 to the Convention on International Civil Aviation and to those portions of the *Procedures for Air Navigation Services — Rules of the Air and Air Traffic Services* applicable to aircraft and of the *Regional Supplementary Procedures* applicable to the PAC region, except for the differences noted in [GEN 1.7](#).

### 2 ATC SEPARATION

#### 2.1 Provision of ATC Separation

2.1.1 Separation **IS** provided;

- (a) between IFR flights in class D airspace (Except that separation is not provided by day in class D airspace when flights have been cleared to climb or descend subject to maintaining own separation in VMC);
- (b) between IFR and SVFR flights;
- (c) between IFR and VFR flights by night in class D airspace;
- (d) between SVFR flights when the flight visibility is reported to be less than 5km; and
- (e) between flights in the aerodrome traffic circuit at controlled aerodromes.

2.1.2 Separation **IS NOT** provided;

- (a) between IFR flights in class G airspace;
- (b) between IFR and VFR flights in class G airspace;
- (c) between IFR and VFR flights by day in class D airspace. (Traffic information concerning VFR flights will, however, be passed to IFR flights;
- (d) between SVFR flights in class C airspace when the flight visibility is reported to be 5km or greater; and
- (e) between VFR flights except when in the aerodrome traffic circuit at controlled aerodromes.

**Note**

Flights operating outside controlled airspace are considered separated from flights within controlled airspace, except that flights entering or leaving controlled airspace shall be provided with separation from flights operating within controlled airspace while they are within an area of conflict.

The separation standards detailed in the following paragraphs are the minimum and may be increased, at the request of the pilot or by ATC, if considered necessary in the interests of safety.

In Class C airspace and in other circumstances as applicable, traffic information is passed when it is known that the relevant flights are or will be in such proximity as to be significant to each other. The provision of traffic information is not intended to relieve the pilot of the responsibility of continued vigilance to see and avoid other aircraft, but is intended to help visual surveillance by drawing attention to possible traffic.

Following the passing of traffic information, pilots may request traffic avoidance advice. The provision of traffic avoidance advice is intended to assist pilots but does not absolve them of the responsibility to avoid collision with other aircraft.



## 2.2 Vertical Separation

2.2.1 Vertical separation is achieved by requiring aircraft to fly at different levels separated by the following minima:

2.2.2 Below FL245

- (a) 1,000ft, except between any two aircraft operating at 4500ft or below within controlled airspace, if both aircraft are either Medium (M) or Low (L) wake turbulence category and the lower aircraft is VFR or SVFR.

2.2.3 At or above FL290

- (a) 2,000ft\*
- (b) When climbing or descending, unless ATC has specified a climb/descent rate and/or time or place of commencement, pilots must initiate climb or descent promptly on acknowledgement of the clearance or advise ATC so that separation from other traffic will not be compromised. The change of level must be made at an optimum rate consistent with the normal operating performance and configuration characteristics of the aircraft to 1,000ft above/below the assigned level, then reduced as appropriate until assigned level is reached. At other times in climb or descent, pilots must advise ATC if they wish to level off at an interim level or substantially change the rate of climb or descent.

### **Note**

\* Reduced vertical separation minima (RVSM) applies between FL290 and FL410 in the Auckland Oceanic FIR. For further information on vertical separation within the Auckland Oceanic FIR, refer to the AIP — New Zealand.

## 2.3 Horizontal Separation

2.3.1 Horizontal separation may consist of:

- (a) longitudinal separation
- (b) lateral separation

## **2.4 Longitudinal Separation**

2.4.1 Longitudinal separation of aircraft is applied so that the spacing between the estimated positions of the aircraft concerned is never less than the prescribed minimum. This minimum will be expressed as a distance or time.

2.4.2 Longitudinal separation is achieved by requiring aircraft to depart at a specified time; to lose time to arrive over a specified location at a specified time; or to hold at a specified location until a specified time.

## **2.5 Lateral Separation**

2.5.1 Aircraft are considered to be laterally separated provided their positions along track are outside an area known as the area of conflict. The area of conflict is established by applying the navigation tolerance for the navigation aid being used for track guidance plus a buffer area, to the two tracks. The point at which the buffer areas cease to overlap is termed the lateral separation point and is normally expressed as a distance from a DME station.

2.5.2 If DME is not available, entry to, or exit from an area of conflict may be determined by the passage of an aircraft over:

- (a) a point beyond the lateral separation point determined by a radio navigation aid; or
- (b) a point beyond the lateral separation point determined by visual reference. (Applicable only to an aircraft leaving an area of conflict by day in MET conditions suitable for flight by visual reference at the cleared level.)

2.5.3 When two aircraft will enter an area of conflict, action will be taken by ATC in sufficient time to ensure that vertical or longitudinal separation exists before the second aircraft passes the lateral separation point on its route. Should doubt exist that an aircraft can reach its assigned altitude before lateral separation is lost, the pilot-in-command must confirm his/her ability to meet the terms of his/her clearance.

## **2.6 Geographical Separation**

2.6.1 Nil.

## **2.7 Use of DME for Separation Purposes**

2.7.1 ATC use of DME to establish or maintain horizontal separation is normally subject to the following:

- (a) direct controller/pilot communication speech maintained;
- (b) aircraft using same DME station; and
- (c) DME station used for separation is on flight track.

## **3 REDUCTION IN SEPARATION MINIMA**

### **3.1 Flights Maintaining Own Separation in VMC in Class D Airspace**

3.1.1 When requested by the pilot, a controlled flight being operated in visual meteorological conditions (VMC) during the hours of daylight may be cleared to fly subject to maintaining own separation and remaining in VMC.

3.1.2 When a controlled flight is so cleared, the following will apply:

- (a) the clearance will be for a specified portion of the flight during climb or descent;
- (b) if there is a possibility that flight under VMC may become impracticable, an IFR flight will be provided with alternative instructions to be complied with in the event that flight in VMC cannot be maintained for the term of the clearance;
- (c) on observing that conditions are deteriorating and considering that operation in VMC will become impossible, the pilot of an IFR flight must inform ATC before entering IMC and proceed in accordance with the alternate instructions given;
- (d) essential traffic information will be passed to all affected flights;
- (e) pilots of all flights which will be essential traffic must agree with the application of the procedure;
- (f) the flights concerned must be on the same ATC frequency.

3.1.3 A clearance will be withheld where it is considered that other flights may be adversely affected or an orderly flow of traffic prejudiced.

3.1.4 The provision of vertical or horizontal separation by ATC is not applicable in respect of any specified portion of a flight cleared subject to maintaining own separation and remaining in VMC. It is the responsibility of the flight so cleared to ensure, that for the duration of the clearance, it is not operated in such proximity to other flights as to create a collision hazard.

### **3.2 Visual Separation**

3.2.1 Standard vertical or horizontal separation may be reduced in the vicinity of aerodromes if:

- (a) adequate separation can be provided by the aerodrome controller when each aircraft is continuously visible to this controller; or
- (b) each aircraft is continuously visible to the pilot of the other aircraft concerned and the pilots thereof report that they can maintain their own separation; or
- (c) in the case of one aircraft following another, the pilot of the succeeding aircraft reports that the other aircraft is in sight and separation can be maintained.

3.2.2 The acceptance of a clearance to “maintain own visual separation from” or to “follow” another aircraft is an acknowledgement that the pilot will keep the other aircraft continuously in sight and maintain adequate separation from that aircraft. When instructed to “maintain own visual separation from” or “to follow” another aircraft, the pilot is required to promptly advise ATC if there is a possibility of visual contact not being maintained, if visual contact is lost or if responsibility for the separation cannot be accepted for any reason.

### 3.3 Composite Visual Separation

3.3.1 Composite visual separation is the application of visual separation by an aerodrome controller in circumstances where only one aircraft is visible to the controller but both the position and the track of a conflicting aircraft are known and the application of geographical separation is not practicable.

3.3.2 Aerodrome control may use composite visual separation to separate an aircraft which is within the aerodrome traffic circuit, from another which is joining or leaving the aerodrome traffic circuit or transiting a control zone, clear of the aerodrome traffic circuit, but not in sight provided:

- (a) the route and intentions of the aircraft which is not in sight are known and its position can be confirmed by radar or other means;
- (b) instructions, when required, are issued to the aircraft in sight which will ensure that adequate separation is maintained.

3.3.3 The term adequate separation in this instance means the spacing required to maintain the safe operation of aircraft or to achieve runway separation without the need for sudden and violent manoeuvres.

## 4 PRIORITIES

### 4.1 General

4.1.1 Provided that safety is not jeopardised, traffic priorities shall be applied in the following order:

- (a) An aircraft known or believed to be in an emergency situation, including unlawful interference.
- (b) A multi-engined aircraft which has had an engine failure, whether or not an emergency has been declared.
- (c) An aircraft with radio communication failure.
- (d) An aircraft on an urgent mercy or ambulance flight, or any aircraft carrying sick or injured persons requiring urgent medical attention.
- (e) An aircraft involved in Search and Rescue or a National Disaster emergency shall be given priority as necessary.
- (f) An aircraft transporting visiting Heads of State, Heads of Government, or other dignitaries visiting Cook Islands, or, when requested by the pilot, aircraft engaged in the transport of the President or Prime Minister.
- (g) A landing aircraft shall generally have priority over a departing aircraft.
- (h) Aircraft landing or taking off shall have priority over aircraft taxiing.
- (i) An aircraft which is first able to use the manoeuvring area or desired airspace in the normal course of its operation shall be given priority, except:
  - (i) where a more orderly traffic flow or a significant economic benefit for a number of other aircraft would result by deferring this priority;
  - (ii) where a significantly greater economic penalty to another aircraft would result, e.g. by permitting a light aircraft to operate ahead of a large jet aircraft;
  - (iii) as a general principle, aircraft in the climb phase should be given preference for routing against arriving aircraft of similar type which are operating at lower power settings with a lesser fuel penalty relating to additional track mileage;

- (iv) flights requiring to operate in other than the normal pattern for operational rather than training reasons should be given the same priority as other flights, unless this introduces a complex traffic situation when approval to operate will be deferred;
- (v) aircraft operating in the traffic pattern in general use shall be given priority over training aircraft desiring to operate in conflicting patterns;
- (vi) where a training instrument approach has been approved, normal priority shall be given to the aircraft from the time it commences final approach;
- (vii) where prior arrangement has been made for flight inspection checks and a priority has been predetermined.

**Notes**

Application of priorities includes priority for landing or take-off, use of airspace and required cruising levels.

Information concerning subparagraphs (d), (e), and (f) should where possible, be included in Section 8 of the International Flight Plan form.

## **5 MINIMUM FLIGHT ALTITUDES**

### **5.1 VFR**

5.1.1 Except when necessary for take-off or landing, or except by permission from the appropriate authority, a VFR flight shall not be flown:

- (a) over the congested areas of cities, towns or settlements or over an open air assembly of persons at a height less than 1000ft above the highest obstacle within a radius of 2000ft from the aircraft;
- (b) above active or normally active volcanoes at a height less than 2,000ft;
- (c) elsewhere other than as specified above, at a height less than 500ft above the ground or water.

### **5.2 IFR**

5.2.1 Except when necessary for take-off or landing, or except when specifically authorised by the appropriate authority, an IFR flight shall be flown:

- (a) over high terrain, in mountainous or volcanic areas, at an altitude which is at least 2,000ft above the highest obstacle within 5NM of the estimated position of the aircraft;
- (b) elsewhere at an altitude which is at least 1,000ft above the highest obstacle located within 5NM of the estimated position of the aircraft.

#### **Note**

The estimated position of aircraft will take account of the navigational accuracy which can be achieved on the relevant route segment, taking into consideration the navigational information available to the pilot.



## ENR 1.2 VISUAL FLIGHT RULES

### 1 GENERAL

#### 1.1 Pilot Responsibilities

1.1.1 It is the responsibility of the pilot to take all possible measures to ensure the avoidance of collision with other aircraft, even when conducting the flight in accordance with an ATC clearance.

#### 1.2 Limitations

1.2.1 Unless authorised by the appropriate ATS authority, VFR flights shall not be operated:

- (a) above FL240
- (b) at transonic and supersonic speeds

#### 1.3 Air Traffic Control Service

1.3.1 VFR flights shall comply with the requirements of section 3.6 of ICAO Annex 2:

- (a) when operated within Class D airspace,
- (b) when forming part of the aerodrome traffic circuit at controlled aerodromes, or
- (c) when operated as Special VFR flights.

#### 1.4 Change of Flight Rules

1.4.1 An aircraft operated in accordance with the visual flight rules which wishes to change to compliance with the instrument flight rules shall:

- (a) if a flight plan was submitted, communicate the necessary changes to be effected to its current flight plan, or
- (b) when so required by section 3.3 of ICAO Annex 2, submit a flight plan to the appropriate air traffic services unit and obtain a clearance prior to proceeding IFR when in controlled airspace.

#### 1.5 Parachute Operations

1.5.1 Parachute operations within Cook Islands must be co-ordinated with the ATS office located in the Control Tower.

## **2 POSITION AND ALTITUDE REPORTING REQUIREMENTS**

### **2.1 VFR Flights Entering Class D Airspace, With ATC in Attendance**

2.1.1 Prior to entry, all VFR flights must establish RTF communication with the appropriate ATC unit, reporting position, intended route, height and destination. The flight must not enter until an ATC clearance is obtained and then must be conducted in accordance with such clearance.

### **2.2 VFR Flights Entering an Aerodrome Traffic Circuit**

2.2.1 Aircraft shall:

- (a) observe other aerodrome traffic for the purposes of avoiding a collision;
- (b) unless otherwise authorised by ATC, conform with the aerodrome traffic circuit formed by other aircraft;
- (c) perform a left-hand aerodrome traffic circuit when approaching for a landing and take-off unless;
  - (i) otherwise authorised by ATC; or
  - (ii) a right-hand aerodrome traffic circuit has been prescribed for aerodrome operations under Part 93.

### **2.3 Frequency Changes**

2.3.1 When establishing contact and no position report is required, pilots must pass level details, giving the altitude or FL (state climbing or descending if not in level flight).

### 3 CLEARANCE FROM CLOUD AND VISIBILITY REQUIREMENTS

#### 3.1 General

3.1.1 Except when operating as a Special VFR flight, VFR flights shall be conducted so that the aircraft is flown in conditions of visibility and distance from clouds equal to or greater than those specified in [Table ENR 1.2 - 1](#).

**Table ENR 1.2 - 1  
VFR Meteorological Minima**

	AIRSPACE CLASS		
	D	G	
		Above 3,000ft AMSL or 1,000ft above terrain, whichever is higher	at or below
FLIGHT VISIBILITY	8km at or above 10,000ft AMSL 5km below 10,000ft AMSL	2km	
DISTANCE FROM CLOUD			Clear of clouds and in sight of ground or water
A) HORIZONTAL	2km	2km	
B) VERTICAL	1,000ft	1,000ft	

3.1.2 Except that helicopters may operate with a flight visibility below 1,500m, clear of clouds and in sight of the ground or water, if manoeuvred at a speed that will give adequate opportunity to observe other traffic or any obstructions in time to avoid collision.

3.1.3 Except where otherwise indicated in air traffic control clearances or specified by the appropriate ATS authority, VFR flights in level cruising flight when operated above 3,000ft from the ground or water, or a higher datum as specified by the appropriate ATS authority, shall be conducted at an altitude or flight level appropriate to the track as specified in the tables of cruising levels.

3.1.4 Except when a clearance is obtained from an air traffic control unit to operate as a Special VFR flight, VFR flights shall not take off or land at an aerodrome within a control zone, or enter the aerodrome traffic zone or traffic circuit:

- (a) when the ceiling is less than 1,500ft, or
- (b) when the ground visibility is less than 5km.

3.1.5 VFR flights between ECT and MCT shall be conducted so that the aircraft is flown in conditions of ground visibility and distance from cloud equal to or greater than 16km and 3,000ft respectively; except that an ATC unit may authorise night training operations by radio equipped aircraft within the aerodrome traffic circuit to approved minima which shall not be less than ground visibility 5km and ceiling 1,500ft.

## **4 POSITION AND ALTITUDE REPORTING REQUIREMENTS**

### **4.1 General**

4.1.1 Position reports are used by ATS to permit the passing of flight or traffic information when necessary, to assist in the sequencing of traffic at controlled aerodromes and for SAR alerting purposes.

### **4.2 Enroute VFR Flights**

4.2.1 VFR flights must maintain a listening watch on the appropriate frequency and must report position at intervals not exceeding 30 minutes. In the event of an aircraft being unable to establish contact within the stipulated period a position report is to be passed as soon as practicable.

4.2.2 Enroute position reports from aircraft operating VFR are to contain the following elements (as appropriate):

- (a) Identification
  - (i) radiotelephony callsign.
- (b) Position
  - (i) in relation to a significant geographical feature.
- (c) Time
  - (i) in minutes past the hour.
- (d) Level
  - (i) altitude or FL (state climbing or descending if not level flight).
- (e) ETA
  - (i) at destination or next landing point as appropriate.
- (f) Route
  - (i) to next significant position.
- (g) Request clearance
  - (i) to enter or transit class D airspace, if applicable.

## **5 AERODROME MET MINIMA FOR OPERATIONS IN CTR**

### **5.1 General**

5.1.1 Except when an ATC clearance is obtained to operate as a Special VFR flight, VFR flights must not take-off from or land at an aerodrome within a CTR/C:

- (a) when the ceiling is less than 1,500ft; or
- (b) when the ground visibility is less than 5km.

### **5.2 MET Minima for Operation as VFR Flight by Night**

5.2.1 Cloud ceiling 3,000ft and ground visibility 16km, except that an ATC unit may authorise night training operations by radio equipped aircraft within the aerodrome traffic circuit down to an approved minima which shall not be less than cloud ceiling 1,500ft and ground visibility 5km.

## 6 SPECIAL VFR FLIGHTS (SVFR)

### 6.1 Aerodrome Meteorological Minima

6.1.1 Meteorological minima for SVFR flights are shown in Table ENR 1.2 - 2.

**Table ENR 1.2 - 2  
VFR Aerodrome Meteorological Minima**

DAY	
Ceiling	at least 600ft
Visibility	1,500m
Distance from cloud	Clear of cloud and in sight of ground or water

### 6.2 General

6.2.1 When traffic permits, an ATC unit may authorise an aircraft to operate in a CTR Class D as a SVFR flight provided that the flight is conducted clear of cloud, beneath a ceiling of 600ft, with a flight visibility of not less than 1,500m by day only and in accordance with the ATC clearance.

6.2.2 The pilot-in-command of an aircraft authorised to operate as a SVFR flight shall comply with instructions issued by the ATC unit.

6.2.3 Authorisation to operate as a SVFR flight does not absolve the pilot from compliance with the Civil Aviation Rules regarding minimum safe heights.

# **Intentionally Blank**



## **ENR 1.3 INSTRUMENT FLIGHT RULES**

### **1 RULES APPLICABLE TO ALL IFR FLIGHTS**

#### **1.1 Classification of IFR Flights**

1.1.1 Flights to be classified as IFR flights are as follows:

- (a) flights in instrument MET conditions;
- (b) flights by night;
- (c) flights to points more than 100NM from land;
- (d) flights for which an IFR flight plan has been submitted; and
- (e) such other flights as may be prescribed by the Director of Civil Aviation.

#### **1.2 Responsibility of Pilot-in-Command**

1.2.1 The Ministry of Transport — Cook Islands, holds the pilot-in-command directly responsible for the avoidance of collision with other aircraft when flying in visual MET conditions while under IFR even though the flight is being conducted in accordance with ATC clearance.

### **1.3 Routing to Avoid Hazardous MET Conditions**

1.3.1 When ATC is aware that hazardous MET conditions exist along the route or flight path of the aircraft, the pilot will be warned of such conditions and, where possible in controlled airspace, ATC will offer the pilot alternative routing to avoid such conditions.

1.3.2 When alternative routing is not available, or the pilot elects to proceed through the conditions, increased separation may be provided by ATC.

1.3.3 In class D airspace the pilot of an aircraft wishing to detour around adverse weather must obtain clearance from ATC. This is necessary to ensure that horizontal separation is not infringed.

### **1.4 Aircraft Equipment**

1.4.1 Aircraft shall be equipped with suitable instruments and with navigation equipment appropriate to the route to be flown.

### **1.5 Change from IFR Flight to VFR Flight**

1.5.1 An aircraft electing to change the conduct of its flight from compliance with the instrument flight rules to compliance with the visual flight rules shall, if a flight plan was submitted, notify the appropriate air traffic services unit specifically that the IFR flight is cancelled by using the phrase "CANCELLING IFR FLIGHT", and communicate the changes to be made to its current flight plan.

1.5.2 When an aircraft operating under the instrument flight rules is flown in or encounters visual meteorological conditions, it shall not cancel its IFR flight unless it is anticipated, that the flight will be continued for a reasonable period of time in uninterrupted visual meteorological conditions.

1.5.3 Within the Cook Islands Sector of the Auckland Oceanic FIR, flights must be conducted in accordance with the instrument flight rules (even if not operating in instrument meteorological conditions), when operating more than 100NM seawards from the shoreline in controlled airspace.

## 2 RULES APPLICABLE TO IFR FLIGHTS WITHIN CONTROLLED AIRSPACE

### 2.1 General

2.1.1 IFR flights shall comply with the provisions of 3.6 of ICAO Annex 2 to the Convention on International Civil Aviation when operated in controlled airspace.

2.1.2 An IFR flight operating in level cruising flight in controlled airspace shall be flown at a cruising level, or, if authorised to employ cruise climb techniques, between two levels or above a level, selected from:

- (a) the tables of cruising levels in [Table ENR 1.7 - 3](#) or
- (b) a modified table of cruising levels, when so prescribed in accordance with Appendix 3 of ICAO Annex 2 for flight above FL410,

except that the correlation of levels to track prescribed therein shall not apply whenever otherwise indicated in air traffic control clearances or specified by the appropriate ATS authority in the Aeronautical Information Publication (AIP).

## 3 RULES APPLICABLE TO IFR FLIGHTS OUTSIDE CONTROLLED AIRSPACE

### 3.1 Cruising Levels

3.1.1 An IFR flight operating in level cruising flight outside of controlled airspace shall be flown at a cruising level appropriate to its track as specified in:

- (a) the tables of cruising levels in [Table ENR 1.7 - 3](#), except when otherwise specified by the appropriate ATS authority for flight at or below 3,000ft above mean sea level; or
- (b) a modified table of cruising levels, when so prescribed in accordance with Appendix 3 of ICAO Annex 2 for flight above FL410.

#### **Note**

This provision does not preclude the use of cruise climb techniques by aircraft in supersonic flight.

## **4 COMMUNICATIONS, POSITION REPORTS AND TRAFFIC INFORMATION OUTSIDE CONTROLLED AIRSPACE**

### **4.1 General**

4.1.1 An IFR flight operating outside controlled airspace but within or into areas, or along routes, designated by the appropriate ATS authority shall maintain a listening watch on the appropriate radio frequency and establish two-way communications, as necessary, with the air traffic services unit providing flight information service.

### **4.2 Position Reports**

4.2.1 The pilot of an IFR flight operating outside controlled airspace is required to:

- (a) maintain a listening watch on the appropriate radio frequency; and
- (b) establish two-way communication as necessary with the ATS unit providing flight information; and
- (c) report:
  - (i) taxiing at unattended aerodromes.
  - (ii) departure time as soon as practicable after departure from an unattended aerodrome.
  - (iii) position enroute at intervals not exceeding 30 minutes.
  - (iv) when changing level.
  - (v) prior to entering controlled airspace.
  - (vi) prior to commencing an instrument approach at an unattended aerodrome
  - (vii) joining the aerodrome traffic circuit at an unattended aerodrome
  - (viii) after landing at unattended aerodromes.

### **4.3 Position Reporting at AFIS Aerodromes**

4.3.1 There are no aerodromes with AFIS in the Cook Islands.

### **4.4 Position and Altitude Reporting — IFR Flights Entering an Aerodrome Traffic Circuit at Unattended Aerodromes**

4.4.1 IFR flights are not permitted to enter an uncontrolled aerodrome traffic circuit in the Cook Islands.

### **4.5 Separation of IFR Flights Outside Controlled Airspace**

4.5.1 When a flight is being conducted under IFR outside controlled airspace, the pilot-in-command is responsible for maintaining separation from other traffic.

4.5.2 To assist pilots in providing their own separation from other traffic, the appropriate ATS unit will, in addition to passing collision hazard information as part of a FIS, on request from the pilot pass information on the movement of other IFR flights in the area:

- (a) prior to departure
- (b) prior to level change
- (c) prior to vacating controlled airspace
- (d) enroute as required
- (e) prior to commencing an instrument approach.

4.5.3 The phrase “NO REPORTED IFR TRAFFIC” will be used when no IFR flights are known to be in the area.

4.5.4 Pilots departing from unattended aerodromes may obtain traffic information from Rarotonga ATS.

4.5.5 Information on the movement of other IFR flights will include information on IFR flights operating in the vicinity of the track of the aircraft concerned at the same level or at level through which the aircraft will pass.

#### 4.6 Position and Altitude Reporting Enroute

##### ***Domestic IFR flights.***

4.6.1 Pilots must report position:

- (a) when over each designated compulsory reporting point, or if the route is not defined by reporting points, at intervals not exceeding 30 minutes;
- (b) prior to entry into controlled airspace;
- (c) at other times when so requested by ATS.

4.6.2 In addition, pilots must report reaching and leaving assigned levels (selected levels if outside controlled airspace).

4.6.3 Position reports must contain the following information in the order listed:

- (a) Identification
  - (i) report radio callsign shown in the flight plan.
- (b) Position
  - (i) use the identification of the navigation aid or name of reporting point over which the report is being made; or
  - (ii) report DME distance from the ATC nominated navigation aid; or
  - (iii) prefix the name of the reporting point by the word "abeam" when not immediately overheard the reporting point; or
  - (iv) report bearing and distance from a significant geographical feature or navigation aid; or
  - (v) if the position cannot be defined as above, report position in latitude and longitude.
- (c) Time
  - (i) Reporting time in minutes past the hour. The time reported must be the actual time of the aircraft at the position and not the time of transmission.

- 
- (d) Flight Level or Altitude
    - (i) Report FL or altitude to the nearest 100ft. In addition, if climbing or descending report "CLIMBING TO" or "DESCENDING TO" as appropriate and the level the aircraft is climbing or descending to.
  - (e) Next Position and Time Over
    - (i) State the position at which the next report will be made and estimated time over the position in minutes past the hour.
  - (f) ETA
    - (i) When the route is outside controlled airspace and not defined by designated reporting points, include ETA at the aerodrome of first intended landing, expressed in hours and minutes.

# **Intentionally Blank**



## ENR 1.4 ATS AIRSPACE CLASSIFICATION

### 1 CLASSIFICATION OF AIRSPACES

#### 1.1 General

1.1.1 ATS airspaces in Cook Islands Sector of the Auckland Oceanic FIR are classified and designated in accordance with the following:

#### 1.2 Class C — CTA

1.2.1 IFR and VFR flights are permitted and all flights are subject to air traffic control service. IFR flights are separated from other IFR flights and from VFR flights. Separation is provided between SVFR flights when the flight visibility is reported to be less than 5km. VFR flights are separated from IFR flights and receive traffic information in respect of other VFR flights.

#### 1.3 Class D — CTR

1.3.1 IFR and VFR flights are permitted and all flights are subject to air traffic control service. IFR flights are separated from other IFR flights, IFR from SVFR flights, and between SVFR flights when the reported visibility is less than 5km. Traffic information is provided to IFR flights about VFR flights and to VFR flights about IFR flights and other VFR flights. Traffic avoidance advice is provided to IFR and VFR flights on request.

#### 1.4 Class G — Uncontrolled Airspace

1.4.1 IFR and VFR flights are permitted and receive flight information service if requested.

1.4.2 The requirements for the flights within each class of airspace are as shown in [Table ENR 1.4 - 1](#).

# **Intentionally Blank**

**Table ENR 1.4 - 1  
Airspace Classification Table**

		<b>CONTROLLED AIRSPACE</b>	<b>UNCONTROLLED AIRSPACE</b>
<b>AIRSPACE CLASSIFICATION</b>		<b>D</b>	<b>G</b>
<b>I F R</b>	SERVICES	Air Traffic Control Service including traffic information about VFR flights (and traffic avoidance advice on request)	Flight information service
	SPEED LIMITATIONS	Max 250kt below 10,000ft AMSL	Max 250kt below 10,000ft AMSL
	RADIO	Yes	Yes
	CLEARANCE	ATC Yes	Not required
SEPARATION		IFR from IFR, SVFR, VFR IFR from VFR at night  VFR from IFR at night  SVFR from SVFR when flight visibility is less than 5km	Not provided
<b>V F R</b>	SERVICES	Air Traffic Control Service including traffic information between VFR/IFR and VFR/VFR flights (and traffic avoidance advice on request)	Flight information service
	VMC MINIMA		
	SPEED LIMITATIONS	Max 250kt IAS below 10,000ft AMSL	Max 250kt IAS below 10,000ft AMSL
	RADIO	Yes	Yes
CLEARANCE	ATC Yes	Not required	

**Intentionally Blank**

## **ENR 1.5 HOLDING, APPROACH AND DEPARTURE PROCEDURES**

### **1 HOLDING**

#### **1.1 General**

1.1.1 The holding, approach and departure procedures in use are based on those contained in the latest edition of ICAO Doc 8168 — *Procedures for Air Navigation Services — Aircraft Operations* (PANS-OPS).

1.1.2 The holding and approach procedures in use have been based on the values and factors contained in Parts III and IV of Vol. I of the PANS-OPS. Holding speeds are shown in [Table ENR 1.5 - 1](#).

**Table ENR 1.5 - 1  
Maximum IAS for Holding Patterns**

FLIGHT LEVEL (FL)	CATEGORY A AND B AIRCRAFT	JET AIRCRAFT	
		NORMAL CONDITIONS	TURBULENCE CONDITIONS
Up to FL140 inclusive	170kt	230kt	280kt or 0.80M, whichever is less
Above FL140 to FL200 inclusive	240kt		
Above FL200 to FL340 inclusive	265kt		
Above FL340		0.83M	

1.1.3 The speed of 280 kt (0.80 M) reserved for turbulent conditions should be used for holding only after prior clearance with ATC. The ATC clearance may include a requirement for an increase in the minimum holding altitude.

1.1.4 Aircraft unable to comply with the above speed restrictions are to advise ATC and request clearance for holding at an acceptable speed. This may result in an ATC requirement for an increase in the minimum holding altitude.

1.1.5 All turns are to be made at a bank angle of 25 degrees, or a rate of 3 degrees per second, whichever requires the lesser bank.

## 2 STANDARD HOLDING PATTERN

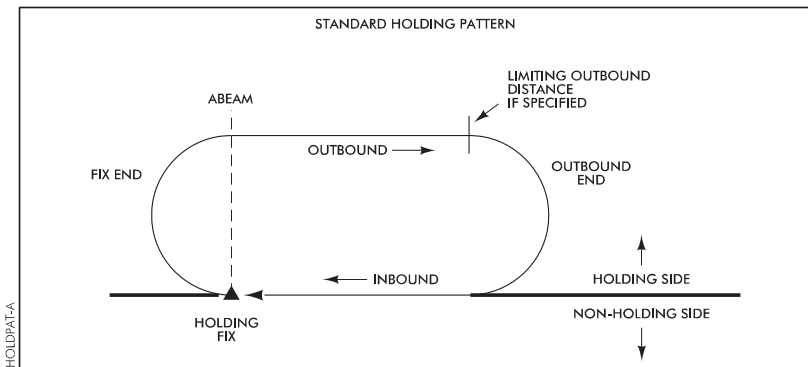
### 2.1 General

2.1.1 Outbound timing begins at the end of turn or abeam the fix, whichever occurs later.

2.1.2 All procedures depict tracks and pilots should attempt to maintain the track by making allowance for known wind by applying corrections both to heading and timing during entry and while flying in the holding pattern.

2.1.3 If the outbound leg length is based on a DME distance the outbound leg terminates as soon as the limiting DME distance is attained. The standard holding pattern is shown in [Figure ENR 1.5 - 1](#).

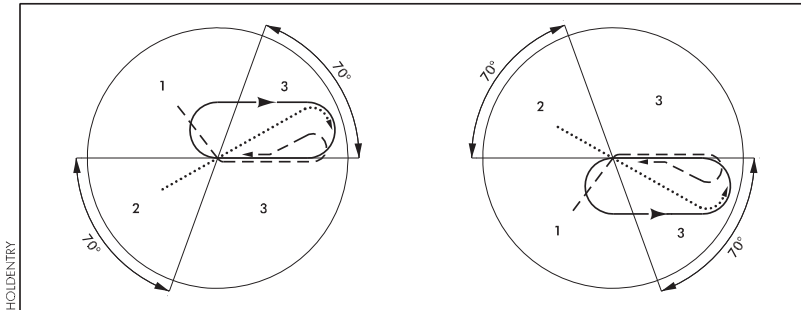
**Figure ENR 1.5 - 1  
Standard Holding Pattern**



## 2.2 Entry Procedures

2.2.1 The entry into the holding pattern must be according to heading in relation to the three entry sectors shown in Figure ENR 1.5 - 2, recognising a zone of flexibility of 5° on either side of sector boundaries. In the case of holding on a VOR/DME fix the entry track is limited to either the VOR radial or DME arc.

**Figure ENR 1.5 - 2  
Holding Pattern Entry Sectors**



### **Sector 1 Procedure (Parallel Entry)**

2.2.2 Having reached the fix, the aircraft is turned onto an outbound heading for the appropriate period of time or until reaching the DME limiting outbound distance, if published; then:

- (a) the aircraft is turned onto the holding side to intercept the inbound track or to return to the fix; and then
- (b) on second arrival over the holding fix, the aircraft is turned to follow the holding pattern.



**Sector 2 Procedure (Offset Entry)**

2.2.3 Having reached the fix, the aircraft is turned onto a heading to make good a track making an angle of 30° from the reciprocal of the inbound track on the holding side; then:

- (a) the aircraft will fly outbound:
  - (i) for the appropriate period of time, or
  - (ii) until the appropriate limiting DME distance is attained, where distance is specified; then
- (b) the aircraft is turned to intercept the inbound holding track; then
- (c) on second arrival over the holding fix, the aircraft is turned to follow the holding pattern.

**Sector 3 Procedure (Direct Entry)**

2.2.4 Having reached the fix the aircraft is turned to follow the holding pattern.

**DME Arc Entry**

2.2.5 Having reached the fix the aircraft is required to enter the holding pattern in accordance with either the Sector 1 or Sector 3 entry procedure.

**Time/Distance Outbound (Sector 1 and 2 Procedures)**

2.2.6 The still time for flying the outbound entry heading should not exceed one minute if at FL140 or below, or one and a half minutes if above FL140. Where DME is available, the length of the outbound leg may be specified and flown in terms of distance instead of time.

**2.3 Holding Procedures and Time — Still Air Conditions**

2.3.1 Having entered the holding pattern, on the second and subsequent arrivals over the fix the aircraft is turned to fly the outbound track.

- (a) Continue outbound:
  - (i) For one minute if at FL140 or below or for one and a half minutes if above FL140, or
  - (ii) until the appropriate limiting DME distance is attained, where distance is specified; then
- (b) turn so as to realign the aircraft on the inbound track.

**2.4 Holding Procedures and Timing — Wind Effect**

2.4.1 Due allowance must be made by the pilot in heading and timing to compensate for the effects of wind to ensure the inbound track is regained before passing the holding fix inbound. In making these corrections full use should be made of the indications available from the aid and estimated or known wind. The limiting DME distance always terminates the outbound leg.

**2.5 Holding Procedures and Timing — Departing the Pattern**

2.5.1 When clearance is received specifying the time of departure from the holding point, the pilot should adjust the pattern within the limits of the established holding procedure in order to leave the holding point at the time specified.

**2.6 Obstacle Clearance — Holding Area**

2.6.1 The holding area includes the basic holding area and the entry area:

- (a) The basic holding area at any particular altitude is the airspace required at the altitude to encompass a standard holding pattern based on the allowances for the aircraft speed, wind effect, timing errors, holding fix characteristics, etc.
- (b) The entry area includes the airspace required to accommodate the specified entry procedures.

**2.7 Obstacle Clearance — Buffer Area**

2.7.1 The buffer area is the area extending 5NM beyond the boundary of the holding area within which the height and nature of obstacles are taken into consideration when determining the minimum holding altitude usable in the holding pattern associated with the holding area.

**2.8 Obstacle Clearance — Minimum Holding Altitude**

2.8.1 The minimum permissible holding altitude will be based initially on a clearance of at least 1,000ft above obstacles in the holding area. The minimum value is increased over areas designated as mountainous terrain.

## **2.9 Precautionary Holding**

### ***Phraseology and Procedures***

2.9.1 To facilitate the provision of procedurally conflict-free flight paths, precautionary holding instructions may be issued to enroute and arriving flights.

2.9.2 The following phraseology and procedures will be used for domestic operations (standard holding instructions will be issued to international flights).

### ***Phraseology***

2.9.3 Examples:

- (a) "Descend to FL130 precautionary hold Sea Horse"
- (b) "Maintain 7,000ft precautionary hold 25 DME"

### ***Procedure***

2.9.4 The precautionary hold:

- (a) May be cancelled prior to the aircraft reaching the designated holding point: "Cancel hold 25 DME"
- (b) If not cancelled, will mean the aircraft must join the designated pattern with an expected onward clearance time/expected approach time of ATA over the REP plus five minutes.

2.9.5 Onward clearance will be given within the five minutes or a new clearance will be issued.

### ***Note***

Although the hold may often be cancelled prior to reaching the aid, cancellation must not be anticipated and normal preparatory action to join the holding pattern must be taken.

### **3 ARRIVING FLIGHTS**

#### **3.1 General**

3.1.1 Traffic above FL245 entering the Cook Islands Sector of the Auckland Oceanic FIR arriving at Rarotonga can expect descent clearance when traffic permits to FL250 from Auckland Oceanic on HF/VHF. Contact instructions will be passed on HF prior to FL250.

3.1.2 Traffic below FL245 entering the Cook Islands Sector of the Auckland Oceanic FIR from adjacent airspace, will be advised by ATS on HF contact instructions prior to the boundary. Rarotonga will provide air traffic services below FL245 outside controlled airspace within the Cook Islands Sector of the Auckland Oceanic FIR during hours of watch. Auckland Oceanic will be responsible for the provision of air traffic services at any time when Rarotonga Tower is off watch.

3.1.3 To facilitate the provision of procedurally conflict-free flight paths, precautionary holding instructions may be issued to enroute and arriving flights.

3.1.4 The precautionary hold instruction may be cancelled prior to the aircraft reaching the designated holding point; however, cancellation must not be anticipated and normal preparatory action to join the holding pattern must be taken. If not cancelled, the aircraft must join the designated holding pattern with an expected onward clearance time of ATA over the REP plus 5 minutes.

3.1.5 Onward clearance will be given within 5 minutes of ATA over the REP or a new onward clearance time will be issued.

3.1.6 ATC will advise the pilot of an IFR flight the ATC preferred type of approach.

3.1.7 Pilots should advise ATC as soon as possible if the nominated approach is not acceptable and advise their intentions.

#### **3.2 Aircraft Speed Restrictions**

3.2.1 In order to facilitate the control of aircraft, general speed restrictions are applied in the vicinity of aerodromes and during procedural manoeuvres. Such restrictions are applied to conserve airspace, improve separation and facilitate procedural arrivals and departures.

3.2.2 Aircraft speed shall not exceed 250kt IAS below 10,000ft AMSL.

## **4 APPROACH PROCEDURES**

### **4.1 The Instrument Approach Procedure**

4.1.1 This term is used to describe a series of predetermined manoeuvres for the orderly transfer of an aircraft under instrument flight conditions from the arrival segment of the approach to a landing, or to a point from which a landing can be made.

### **4.2 Instrument Approach Fixes**

4.2.1 Where positive fixes are available on an instrument approach procedure, either by DME, NDB, VOR or Marker, they may be designated to identify the segment to be commenced. These are:

- (a) initial approach fix (IAF)
- (b) intermediate approach fix (IF)
- (c) final approach fix (FAF) or final approach point
- (d) missed approach point (MAPt)

### **4.3 Instrument Approach Segments**

4.3.1 An instrument approach procedure may be divided into five separate segments as detailed below. Depending on the type of procedure, all of the first three segments need not necessarily be established.

#### ***Arrival Segment***

4.3.2 That segment of an instrument approach procedure that connects the enroute phase to an initial approach fix. An arrival segment may consist of published arrival routes.

#### ***Initial Approach Segment***

4.3.3 That segment of an instrument approach procedure between the initial approach fix and the intermediate approach fix or where applicable the final approach fix or point. (The final approach point is the intersection of the normal glide path and the minimum altitude specified for the previous segment). The initial approach segment includes any DME arc or reversal procedure.

### ***Intermediate Approach Segment***

4.3.4 That segment of an instrument approach procedure between either:

- (a) the intermediate approach fix and the final approach fix or point; or
- (b) the end of a reversal or dead reckoning track procedure and the final approach fix or point as appropriate.

### ***Final Approach Segment***

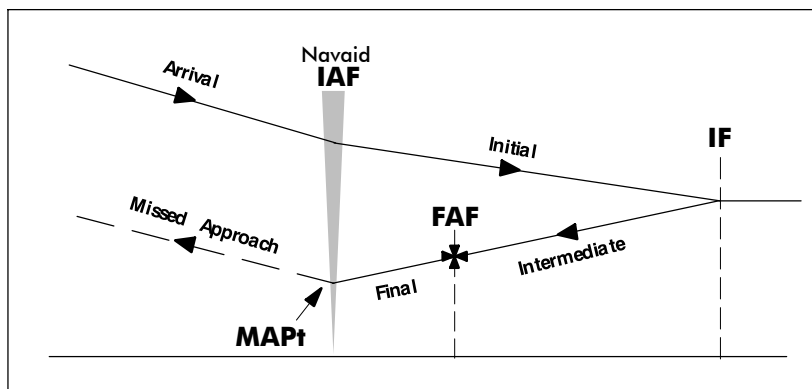
4.3.5 That segment of an instrument approach procedure in which alignment and descent for landing are accomplished. It begins at the final approach fix or point and ends at the missed approach point.

### ***Missed Approach Segment***

4.3.6 That segment of an instrument approach between the missed approach point and a specified altitude or point. (The missed approach point is that point at or before which the prescribed missed approach procedure must be initiated in order to ensure that the minimum obstacle clearance is not infringed.)

4.3.7 **Figure ENR 1.5 - 3** shows the typical segments and fixes that may be specified on a tear-drop instrument approach procedure.

**Figure ENR 1.5 - 3  
Tear-drop Approach Segments**



#### 4.4 Procedure Speeds

4.4.1 As shown in [Table ENR 1.5 - 2](#), a specified range of landing speeds for each category of aircraft has been assumed for use in calculating airspace and obstacle clearance requirements for each procedure. An aircraft may use a higher category provided that:

- (a) the minima and restrictions for the higher category are authorised and complied with; and
- (b) ATC has been advised

4.4.2 For further information on aircraft approach categories see [paragraph 4.7](#).

**Table ENR 1.5 - 2  
Speeds for Procedure Calculations**

CAT	V <sub>at</sub>	RANGE OF SPEEDS FOR INITIAL APPROACH	RANGE OF SPEEDS FOR FINAL APPROACH	MAXIMUM SPEED FOR CIRCLING APPROACH	MAXIMUM SPEED FOR MISSED APPROACH #
<b>A</b>	Less than 91kt	90 – 150kt (110kt*)	70 – 100kt	100kt	110kt
<b>B</b>	91kt or more but less than 121kt	120 – 180kt (140kt*)	85 – 130kt	135kt	150kt
<b>C</b>	121kt or more but less than 141kt	160 – 240kt	115 – 160kt	180kt	240kt
<b>D</b>	141kt or more but less than 166kt	185 – 250kt	130 – 185kt	205kt	265kt

#### Notes

V<sub>at</sub> — speed at threshold based on 1.3 x V<sub>s</sub> in the landing configuration at maximum certified landing weight

\* — Maximum speed for reversal procedures

# — unless other wise specified on instrument approach chart



## 4.5 Minima

### ***Non-Precision Approach***

4.5.1 Straight-in and circling minimum descent altitude (MDA) is a specified altitude below which descent may not be made without visual reference. When visual reference has been established on a circling approach, descent below MDA is at the discretion of the pilot provided that:

- (a) visual reference can be maintained throughout the circling approach; and
- (b) the landing threshold or approach lights or other marking identifiable with the approach end of the runway are visible; and
- (c) the required obstacle clearance can be maintained to a position from where the remaining flight path distance to the intended touch-down point will allow a constant rate of descent.

4.5.2 MDA ensures compliance with the required obstacle clearance criteria and where applicable it includes a margin based on operational considerations of ground and airborne equipment characteristics, aircraft performance, meteorological conditions, aerodrome characteristics, location of guidance aids relative to the runway and mountainous terrain. Operators may wish to increase the MDA to account for pilot qualifications and experience.

### ***Note***

For a straight-in approach, the angle formed by the final approach track on the runway centreline may be as much as 30 degrees.

***Precision Approach***

4.5.3 Decision altitude (DA) is a specified altitude in the precision approach at which a missed approach must be initiated if the required visual reference to continue the approach has not been established.

4.5.4 The required visual reference means that section of the visual aids, or of the approach area, which should have been in view for sufficient time for the pilot to have made an assessment of the aircraft position and rate of change of position in relation to the desired flight path.

4.5.5 Decision altitude ensures compliance with the appropriate obstacle clearance criteria and where applicable, includes a margin based on operational considerations of ground and airborne equipment characteristics, aircraft performance, meteorological conditions, aerodrome characteristics and altimetry. Operators may wish to increase the DA to account for pilot qualifications and experience.

**4.6 Application of Minima*****Minimum Descent Altitude (MDA)***

4.6.1 If at MDA any element of the aerodrome meteorological minima is below that prescribed, the pilot is to maintain MDA until not later than the designated missed approach point is reached and then initiate the missed approach procedure.

***Decision Altitude (DA)***

4.6.2 If at DA the required visual reference to continue the approach has not been established, the pilot must initiate the missed approach procedure immediately.

#### 4.7 Aircraft Approach Categories

4.7.1 IFR straight-in and circling to land minima are depicted on Instrument Approach Charts in accordance with "Aircraft Approach Categories".

4.7.2 There are four aircraft approach categories published in Cook Islands under ICAO PANS OPS II Criteria which cater for ranges of speeds in terms of  $1.3V_s$ , where  $V_s$  is stall speed in the landing configuration at maximum certificated landing weight. A list of common aircraft types in accordance with their category is shown in [Table ENR 1.5 - 3](#).

**Table ENR 1.5 - 3**  
**Aircraft Category**

CATEGORY 1.3VS (KNOTS IAS)		AIRCRAFT TYPES
<b>A</b>	Less than 91kt	Cessna 402, Piper Seneca, Britten Norman Islander, DHC6, PA31, Navajo
<b>B</b>	91kt or more but less than 121kt	Fokker F27, BA HS748, Cessna 421, ATR 72, Metro III, Saab 340, Bandeirante, DH8A
<b>C</b>	121kt or more but less than 141kt	B737 Series, B727 Series, BAe 146, B767-200, Airbus 318, 319, 320, 321
<b>D</b>	141kt or more but less than 166kt	B747-200 Series, MD11, B767-300
ATC must be notified whenever an aircraft is to be operated at different category to that contained in the above table.		

**4.8 Landing minima format**

CATEGORY	A	B	C	D
ILS		360 (330) – 1200		
LOC		440 (410) – 1500		
CIRCLING	600 (550) – 1900	700 (650) – 2800	800 (750) – 3700	900 (850) – 4600

DA (Decision Altitude) points to the 360 value in the ILS row.  
 Height above THR ELEV (Threshold Elevation) points to the 330 value in the ILS row.  
 Height above AD ELEV, or THR ELEV if THR ELEV more than 7ft below AD ELEV points to the 1200 value in the ILS row.  
 MDA (Minimum Descent Altitude) points to the 600 value in the CIRCLING row.  
 Height above aerodrome elevation points to the 650 value in the CIRCLING row.  
 Visibility points to the 800 value in the CIRCLING row.

**4.9 Instrument Approach Procedure Timing**

*Tear drop procedures*

4.9.1 To ensure that the obstacle clearance margins are not infringed, no increase in the instrument approach procedure outbound time or outbound DME distance is authorised; except that, where aircraft are operated on the outbound leg of the tear drop instrument approach procedure at indicated air speeds significantly lower than the maximum authorised for the procedure, the outbound timing may be adjusted in accordance with [Table ENR 1.5 - 4](#).

**Table ENR 1.5 - 4  
Instrument Approach Procedure — Timing Adjustment**

PROCEDURE TIMING SHOWN ON CHART	MODIFIED PROCEDURE TIMING RELATED TO AIRCRAFT APPROACH SPEED (IAS)	
	91 – 110kt	70 – 90kt
2 minutes	2.5 minutes	3 minutes
3 minutes	4 minutes	4.5 minutes

4.9.2 Outbound time or DME distance may be shortened, provided that the wind velocity at the relevant altitudes has been confirmed by an immediately preceding instrument approach to the effect that minimum altitude may be reached at an acceptable descent rate during final approach.

#### **4.10 Position Reporting During Instrument Approach at a Controlled Aerodrome**

4.10.1 Unless otherwise instructed by ATC, aircraft cleared to make an instrument approach must report:

- (a) When overhead the navigation aid prior to commencing reversal turn.
- (b) When overhead the navigation aid outbound commencing initial approach.
- (c) When established on DME arc.
- (d) When commencing procedure or base turn leading to intermediate/final approach.
- (e) When established on Intermediate/final approach
- (f) When the ground or water becomes continually visible and flight by instruments is no longer required (i.e. "Visual").
- (g) When commencing missed approach.

#### **4.11 Visual Approach — Controlled Airspace**

4.11.1 IFR flights in controlled airspace may be cleared for visual approaches provided the pilot:

- (a) specifically states "REQUEST VISUAL APPROACH", and
- (b) can maintain visual reference to the terrain, and
- (c) the reported ceiling is not below the approved initial approach level for the aircraft so cleared; or
- (d) the pilot reports, at the initial approach level or at any time during the instrument approach procedure, that the meteorological conditions will permit a visual approach and that there is a reasonable assurance that the landing can be accomplished.

4.11.2 An aircraft operating under IFR and making a visual approach remains an IFR flight and is subject to ATC clearances for the purpose of providing separation.

4.11.3 When cleared by ATC for a visual approach further descent is unrestricted except when a specific restriction or requirement is included with the clearance for a visual approach or is included in a subsequent clearance. Any ATC altitude restriction remains in force until specifically cancelled. As well, ATC may require a pilot to position by reference to geographic features.

4.11.4 ATC may nominate a visual approach by day only, when the visibility is at least 16km and the ceiling is at least 1,000ft above the applicable instrument approach procedure commencement altitude.

4.11.5 If visual reference to terrain is established before completion of an instrument approach procedure, the entire procedure must nevertheless be executed unless the pilot requests and is cleared for a visual approach.

4.11.6 For a visual approach at night, it is essential that the pilot has the runway lights in sight. Sighting only of the aerodrome beacon, REIL's, circling guidance lights or approach lights is insufficient.

#### **4.12 Visual Approach — Uncontrolled Airspace**

4.12.1 Pilots in uncontrolled airspace may carry out a visual approach provided the pilot has the aerodrome in sight, can maintain visual reference and:

- (a) the ceiling is not below the initial approach level; or
- (b) the pilot has reasonable assurance at the initial approach level or at any time during the instrument approach procedure that the meteorological conditions will permit a visual approach and landing to be accomplished.

#### **4.13 Visual Reference — Descent Below Minimum Altitude or Minimum Descent Altitude**

4.13.1 Pilots carrying out an instrument approach may continue descent below minimum altitude, minimum descent altitude or decision altitude, provided:

- (a) by day, continuous visual reference with the ground along the flight path has been established and can be maintained; and
- (b) by night, the circling guidance lighting and/or approach lighting and aerodrome lighting is in sight and can be maintained.
- (c) the visibility is equal to or greater than that prescribed for the procedure; and
- (d) the aircraft is in a position from which a descent to a landing on the intended runway can be made using normal manoeuvres and descent rates to the touchdown zone.

#### **4.14 Visual Segment Surface (VSS)**

4.14.1 A surface applicable to instrument approach procedures with straight-in minima only. Its purpose is to protect the visual component of an instrument flight from the point where the obstacle clearance height is reached until landing.

4.14.2 VSS originates at a point 60m from the landing threshold, at threshold height, has a slope 1.12° below the promulgated approach angle, and ends where the surface reaches the MDA or DA.

4.14.3 Obstacles less than 15m above the threshold are ignored; higher obstacles penetrating the VSS are to be removed or require an aeronautical study, which may result in an increased approach angle, displaced threshold, or other acceptable mitigating action.

#### **4.15 Unattended Aerodromes — QNH Source**

4.15.1 The MDA for an instrument approach at an aerodrome is calculated on the assumption that an accurate QNH is available at that aerodrome. To reflect this, most instrument approach charts are annotated with the QNH instruction:

“Use (LOCAL) QNH”

### ***Use of Remote QNH***

4.15.2 If an accurate QNH is not available from an unattended aerodrome, the QNH from another aerodrome may be used, but a correction must be made to the promulgated MDA as follows:

- (a) Add 5ft to the MDA for every 1 NM in excess of 5 NM from the source of the QNH.

### ***When Use of Remote QNH is Not Authorised***

4.15.3 At some aerodromes, because of the non-homogeneous nature of weather conditions in mountainous terrain, a remote QNH setting must not be used for determining MDA or DA. At these locations, if the local QNH is not available, the approach **cannot** be used. At such aerodromes the QNH instructions will state:

“Use (LOCAL) QNH only”

4.15.4 Remote QNH is not to be used when flying RNAV (RNP) approaches. If the local QNH is not available, the approach cannot be used. On such approaches the QNH instructions will state:

“Use (LOCAL) QNH only”

4.15.5 Remote QNH is not to be used when flying RNAV approaches with barometric vertical path guidance (Baro-VNAV), that is to LNAV/VNAV minima. The LNAV/VNAV minima entry will be annotated:

“Use of remote QNH NA”.

## **4.16 IFR Arrival Procedures — Unattended Aerodromes**

4.16.1 Pilots carrying out an instrument approach at an aerodrome that is unattended are required to follow the RTF procedures for unattended aerodromes.

4.16.2 It is important that the minimum altitude is not infringed and flight to the aerodrome is not continued unless the pilot is satisfied that integration with circuit traffic operating in flight visibilities down to 1500m can be achieved. Where traffic confliction is likely, descent in IMC should be restricted to 1200ft above aerodrome elevation.

4.16.3 When a non-DME instrument approach is being carried out at an uncontrolled aerodrome, MDA should be attained as soon as possible after the end of base turn, as VFR aircraft may be operating close to the cloud base in the vicinity of the aerodrome and approach aid.

4.16.4 Pilots of aircraft operating on an IFR flight plan and executing an instrument approach are reminded that in terminating the instrument approach for landing they are initiating visual flight in uncontrolled airspace and the rules applicable to such operations apply.



#### **4.17 RNAV/Baro-VNAV Approach Procedures**

4.17.1 LNAV/VNAV minima will be shown only in cases where the procedure has been evaluated using PANS-OPS Baro-VNAV criteria.

4.17.2 Use of LNAV/VNAV minima is authorised only if the aircraft is equipped with an approved navigation system which presents to the pilot computed vertical guidance referenced to the promulgated vertical path angle (VPA).

4.17.3 Use of LNAV/VNAV minima is not authorised using remote QNH.

4.17.4 Published LNAV/VNAV minima will always include a note in the minima box regarding the applicable minimum temperature to which the use of the minima is authorised. If aerodrome temperature drops below the published minimum, LNAV shall apply.

4.17.5 RNAV (RNP) approaches are procedures with vertical guidance and require VNAV guidance systems. RNAV (RNP) approaches require special authorisation and are only available to approved operators.

4.17.6 Use of RNAV (RNP) minima is not authorised using remote QNH.

4.17.7 Published RNAV (RNP) minima will always include a note regarding the applicable minimum and maximum temperatures to which the approach can be used. If the aerodrome temperature is outside the published range, the approach cannot be used.

## 5 DEPARTING FLIGHTS

### 5.1 General

5.1.1 Aircraft departing from Rarotonga for levels above FL245 can expect their ATC clearance via Rarotonga Tower prior to start. HF contact instructions will be passed on by Rarotonga Tower after departure. During hours of watch Rarotonga will provide air traffic services below FL245 outside controlled airspace within the Cook Islands Sector of the Auckland Oceanic FIR.

5.1.2 Detailed instructions with regard to routes, turns, etc. may be issued prior to or after take-off.

5.1.3 Published departure procedures provide routing to avoid most high terrain which may be relatively close to the aerodrome. Where this is not possible minimum set heading altitudes or visual segments will be prescribed. In emergency circumstances, however, terrain clearance cannot be guaranteed under all conditions of operation, due to aircraft performance.

5.1.4 The pilot-in-command must consider the one engine inoperative climb performance of the aircraft in relation to the height of terrain over which the climb is planned. Where adequate terrain clearance in IMC under the ambient conditions cannot be ensured it must be determined before departure that, in the event of engine failure prior to reaching MSA, or the level acceleration altitude, adequate action can be taken to protect the aircraft. It is expected that this action will normally involve a turn to climb out over the sea until either MSA is reached or approval is granted for a re-join for approach and landing.

5.1.5 Departure procedures may consist of:

- (a) A standard instrument departure procedure (SID)
- (b) Departure climbing above DME steps
- (c) By day only, having due regard to prevailing MET conditions, a visual departure maintaining own terrain clearance to route MSA or set heading point and altitude
- (d) A specified track

5.1.6 Aircraft are to intercept the specified departure track by the shortest practical means after take-off, unless otherwise promulgated in the appropriate departure procedure.

5.1.7 Where no departure procedures are promulgated for a route, the pilot-in-command is to ensure that the climb performance of the aircraft is adequate for providing terrain clearance prior to reaching minimum safe altitude.

## 5.2 Standard Instrument Departure (SID)

5.2.1 Standard Instrument Departures (SID) are used to standardise departure instructions, reduce the possibility of RTF congestion, reduce the chance of error in aircraft routing and provide a positive routing for aircraft suffering communications failure.

5.2.2 The SID provides in both diagrammatic and narrative form the direction of turn, headings, track and in some cases altitude requirements. Where tracking to or from a navigation aid is not possible, desired tracks are shown and due allowance for wind is to be made. Aircraft are to continue climbing throughout the SID unless otherwise instructed.

5.2.3 SID's are identified by departure runway, and direction of destination.

5.2.4 All departure procedures including SID's, designed to ICAO PANS-OPS II criteria, portray the minimum net climb gradient to achieve the designed obstacle clearance margins for the desired tracks to be flown.

5.2.5 Operators or pilots should establish procedures to ensure compliance with the SID. The application of a performance margin on the published climb requirements is at the operator's/pilot's discretion taking into account the achievable climb performance of the aircraft and the means of monitoring the gradient achieved.

5.2.6 When it is not possible to nominate a specified SID, ATC will issue any required departure instructions in plain language.

## 5.3 IFR Alternate Aerodrome Minima

5.3.1 New Zealand CAR 91.405 prescribes IFR alternate aerodrome requirements.

5.3.2 In accordance with CAR 91.405 an aerodrome must not be listed as an alternate aerodrome unless the weather forecast at the time of submitting the flight plan indicates that, at the estimated time of arrival, the ceiling and visibility at that aerodrome will be at or above the following weather minima:

- (a) For a precision approach procedure, ceiling of 600 ft or 200 ft above DA/DH, whichever is the higher, and visibility of 3000 m or 1000 m more than the prescribed minimum, whichever is the greater.
- (b) For a non-precision approach procedure, ceiling of 800 ft or 200 ft above MDA, whichever is the higher, and visibility of 4000 m or 1500 m more than the prescribed minimum, whichever is the greater.
- (c) If no instrument approach procedure is published for the alternate aerodrome, the ceiling and visibility minima prescribed under CAR Part 91 subpart D for an air operation under VFR, for descent below the minimum altitude for IFR flight prescribed under CAR 91.423.

# **Intentionally Blank**

## **ENR 1.6 RADAR SERVICES AND PROCEDURES**

### **1 SERVICES**

#### **1.1 General**

1.1.1 Nil.

# **Intentionally Blank**

## ENR 1.7 ALTIMETER SETTING PROCEDURES

### 1 INTRODUCTION

#### 1.1 General

1.1.1 The altimeter setting procedures in use in Cook Islands generally conform to those contained in ICAO Doc 8168, Vol. I, Part 6 and are given in full below.

1.1.2 QNH reports and temperature information for use in determining adequate terrain clearance are provided by the ATS unit (aerodrome control tower or flight service station) serving the aerodrome during its hours of watch. QNH values are given in hectopascals, rounded down to the nearest whole hectopascal.

1.1.3 For altimeter setting procedures within the Auckland Oceanic FIR, refer to AIP — New Zealand.

### 2 BASIC ALTIMETER SETTING PROCEDURES

#### 2.1 General

2.1.1 The transition altitude in the Cook Sector is 13,000ft, and the transition level is FL150.

2.1.2 Vertical positioning of aircraft when at or below the transition altitude is expressed in terms of altitude, whereas such positioning at or above the transition level is expressed in terms of flight levels. While passing through the transition layer, vertical positioning is expressed in terms of altitude when descending and in terms of flight levels when ascending. Within the Cook Sector of the Auckland Oceanic FIR, the transition layer between 13,000ft and FL150, can only be used for ascending and descending, or for cruising provided the aircraft has ATS approval.

2.1.3 The transition layer between the transition altitude of 13,000ft and the transition level of FL150 provides adequate separation between aircraft using a zone QNH setting and aircraft operating on the standard pressure value (1013 hPa) when the QNH is above 980 hPa. However, when a zone QNH is 980 hPa or lower, the lowest usable flight level above the QNH zone shall be FL160.

2.1.4 Flight level zero is located at the atmospheric pressure level of 1013.2 hPa. Consecutive flight levels are separated by a pressure interval corresponding to 500ft in the standard atmosphere.

2.1.5 Examples of the relationship between flight levels and altimeter indications are given in [Table ENR 1.7 - 1](#).

**Table ENR 1.7 - 1  
Flight Level and Altimeter Indications**

<b>FLIGHT LEVEL (NUMBER)</b>	<b>ALTIMETER INDICATION (FT)</b>
10	1,000
15	1,500
20	2,000
50	5,000
100	10,000
150	15,000
200	20,000

2.1.6 A QNH altimeter setting is made available to aircraft in departure information prior to start-up.

2.1.7 Aircraft required to maintain vertical position by reference to a QNH altimeter setting must use the appropriate area QNH for flight at or below the transition altitude except that the appropriate aerodrome QNH must be used for:

- (a) take-off, landing and flight within an aerodrome traffic circuit;
- (b) the intermediate and final approach of an instrument approach procedure;
- (c) flight in a CTR.

2.1.8 Vertical positioning of aircraft during climb is expressed in terms of altitudes until reaching the transition altitude above which vertical positioning is expressed in terms of flight levels.

2.1.9 Within the Cook Sector of the Auckland Oceanic FIR, aircraft operating at or below the transition altitude must maintain vertical position by reference to the appropriate zone QNH, except that aircraft taking off or operating within a CTR must use the appropriate aerodrome QNH.



## **2.2 Take-off and Climb**

2.2.1 Aircraft departing from an aerodrome where no QNH value is available are required to set the aerodrome elevation on the altimeter prior to departure and obtain the appropriate altimeter setting as soon as possible, and in any case, before entering instrument meteorological conditions.

## **2.3 Vertical Separation — Enroute**

2.3.1 Vertical separation during enroute flight shall be expressed in terms of flight levels, or in terms of altitudes for aircraft at or below the transition altitude in a defined Area QNH Zone.

2.3.2 IFR flights, and VFR flights above 3,000ft, when in level cruising flight shall be flown at such altitudes or flight levels, corresponding to the magnetic tracks shown in [Table ENR 1.7 - 3](#), so as to provide the required terrain clearance.

### **Note**

Some of the lower levels in [Table ENR 1.7 - 3](#) may not be usable due to terrain clearance requirements.

## **2.4 Approach and Landing**

2.4.1 A QNH altimeter setting is made available to inbound flights in arrival information by the unit providing approach control service. A QNH altimeter setting is also made available in any clearance to enter the traffic circuit.

## **2.5 QFE Altimeter Settings**

2.5.1 QFE altimeter settings are not available.

## **2.6 Missed Approach**

2.6.1 The relevant portions of 2.1, 2.2 and 2.4 shall be applied in the event of a missed approach.

### 3 DESCRIPTION OF AREA QNH ZONES

#### 3.1 General

3.1.1 There is one Area QNH Zone in the Cook Sector as shown in [Table ENR 1.7 - 2](#).

**Table ENR 1.7 - 2  
Area QNH Zones**

NAME	DESCRIPTION
<b>RAROTONGA</b>	All that airspace within the lateral limits of the Rarotonga CTA. <b>Upper limit:</b> 13,000ft AMSL <b>Lower limit:</b> Surface

### 4 PROCEDURES APPLICABLE TO OPERATORS (INCLUDING PILOTS)

#### 4.1 Flight Planning

4.1.1 The levels at which a flight is to be conducted shall be specified in a flight plan:

- (a) in terms of flight levels if the flight is to be conducted at or above the transition level, or at any level over the high seas;
- (b) in terms of altitudes if the flight is to be conducted within the Rarotonga Area QNH Zone; or
- (c) as "VFR" if the flight is to be conducted in accordance with the visual flight rules.

## 5 TABLE OF CRUISING LEVELS

### 5.1 General

5.1.1 Unless authorised by ATC during flight within controlled airspace, cruising levels within the Cook Sector must be in accordance with [Table ENR 1.7 - 3](#).

**Table ENR 1.7 - 3**  
**Table of Cruising Levels**

	000° – 179°		180° – 359°	
	IFR	VFR	IFR	VFR
<b>ALTITUDE</b>	1,000		2,000	
	3,000	3,500	4,000	4,500
	5,000	5,500	6,000	6,500
	7,000	7,500	8,000	8,500
	9,000	9,500	10,000	10,500
	11,000	11,500	12,000	12,500
	13,000			
<b>FLIGHT LEVEL NUMBER</b>	150	155	160	165
	170	175	180	185
	etc	etc	etc	etc
		up to 235		up to 240
	270	NA	280	NA
	290		300	
	up to 410		up to 400	
	then 450, 490 etc		then 430, 470 etc	

#### Notes

The levels between 13,000ft and FL150 are not available for level flight.

FL150 must not be used as a cruising level when the area QNH is 980hPa or less.

For operations above FL245, refer to the AIP — New Zealand.

# **Intentionally Blank**

## **ENR 1.8 REGIONAL SUPPLEMENTARY PROCEDURES**

### **1 INTRODUCTION**

#### **1.1 General**

1.1.1 Nil.

# **Intentionally Blank**

## **ENR 1.9 AIR TRAFFIC FLOW MANAGEMENT (ATFM)**

### **1 INTRODUCTION**

#### **1.1 General**

1.1.1 Nil.

# **Intentionally Blank**



## **ENR 1.10 FLIGHT PLANNING (RESTRICTION, LIMITATION OR ADVISORY INFORMATION)**

### **1 PROCEDURES FOR THE SUBMISSION OF A FLIGHT PLAN**

#### **1.1 General**

1.1.1 A flight plan shall be submitted in accordance with ICAO Annex 2, 3.3.1, prior to operating:

- (a) any IFR flight
- (b) any VFR flight (including special VFR and controlled VFR flights) in the Cook Islands Sector
- (c) any flight within an aerodrome traffic circuit when an ATC service is being provided.

#### **1.2 Time of Submission**

1.2.1 Except for repetitive flight plans, a flight plan shall be submitted at least 30 minutes prior to departure, taking into account the requirements of ATS units in the airspace along the route to be flown for timely information.

#### **1.3 Place of Submission**

1.3.1 All flight plans shall be submitted to the Rarotonga ATS Unit.

1.3.2 During hours of watch and subject to workload, a flight plan may be submitted by RTF.

#### **1.4 Contents and Form of a Flight Plan**

1.4.1 ICAO Flight Plan forms are available at Rarotonga ATS Unit. The instructions for completing those forms shall be followed. For the completion of the ICAO Flight Plan Form see [section 1.6](#).

1.4.2 Flight plans concerning international IFR flights along ATS routes need to include FIR-boundary estimates.

1.4.3 When a flight plan is submitted by telephone or facsimile, the sequence of items in the flight plan shall be strictly followed.

#### **1.5 Adherence to ATS Route Structure**

1.5.1 All flight plans shall be submitted for published ATS routes. Where this is not possible for the entire flight or any portion thereof, the relevant parts of the instructions for completing a flight plan shall be followed.

## **1.6 Completing the ICAO Flight Plan Form**

1.6.1 Adhere to the prescribed formats and manner of specifying data as follows:

- (a) commence inserting data in the first place provided
- (b) where excess space is available leave unused spaces blank
- (c) insert all clock times in 4 figures UTC
- (d) insert all estimated elapsed times in 4 figures (hours and minutes)
- (e) areas preceding Item 3 are for ATS use

### ***Instructions for Insertion of Data***

1.6.2 Complete Items 7 to 19 as indicated in the following sections.

#### **Note**

Item numbers on the form are not consecutive, as they correspond to Field Type numbers in ATS messages.

### ***ITEM 7: AIRCRAFT IDENTIFICATION (MAXIMUM 7 CHARACTERS)***

1.6.3 **INSERT** one of the following aircraft identifications, not exceeding 7 characters:

- (a) the registration marking of the aircraft (e.g. 5W ABC5, N1234D), when in radiotelephony the call sign to be used by the aircraft will consist of this identification alone (e.g. 5W ABC5), or preceded by the ICAO telephony designator for the aircraft operating agency (e.g. AIRFLIGHT 5W ABC5);

#### **OR**

- (b) the ICAO designator for the aircraft operating agency followed by the flight identification (AFT12, SAM710) when in radiotelephony the call sign to be used by the aircraft will consist of the ICAO telephony designator for the operating agency followed by the flight identification (AIRFLIGHT12, SAMOA 710).

**ITEM 8: FLIGHT RULES AND TYPE OF FLIGHT (ONE OR TWO CHARACTERS)****FLIGHT RULES**

1.6.4 **INSERT** one of the following letters to denote the category of flight rules with which the pilot intends to comply:

<b>I</b>	if IFR	
<b>V</b>	if VFR	
<b>Y</b>	if IFR first	and specify in Item 15 the point or points where a change of flight rules is planned.
<b>Z</b>	if VFR first	

**TYPE OF FLIGHT**

1.6.5 **INSERT** one of the following letters to denote the type of flight:

<b>S</b>	if scheduled Air Service
<b>N</b>	if non-scheduled Air Transport Operation
<b>G</b>	if General Aviation
<b>M</b>	if Military
<b>X</b>	if Other than any of the defined categories above.

**ITEM 9: NUMBER AND TYPE OF AIRCRAFT AND WAKE TURBULENCE CATEGORY****NUMBER OF AIRCRAFT (1 OR 2 CHARACTER)**

1.6.6 **INSERT** the number of aircraft, if more than one.

**TYPE OF AIRCRAFT (2 TO 4 CHARACTERS)**

(a) **INSERT** the appropriate designator as specified in ICAO Doc 8643, Aircraft Type Designators,

**OR**

(b) if no such designator has been assigned, or in case of formation flights comprising more than one type, **INSERT ZZZZ**, and **SPECIFY** in Item 18, the (numbers and) type(s) of aircraft preceded by **TYP/**.

**WAKE TURBULENCE CATEGORY (1 CHARACTER)**

1.6.7 **INSERT** an oblique stroke followed by one of the following letters to indicate the wake turbulence category of the aircraft:

<b>H</b>	<b>HEAVY</b> to indicate an aircraft type with a maximum certificated take-off mass of 136,000 kg or more
<b>M</b>	<b>MEDIUM</b> to indicate an aircraft type with a maximum certificated take-off mass of less than 136,000 kg but more than 7,000 kg
<b>L</b>	<b>LIGHT</b> to indicate an aircraft type with a maximum certificated take-off mass of 7,000 kg or less.

**ITEM 10: EQUIPMENT****RADIO EQUIPMENT, NAVIGATION AND APPROACH AID EQUIPMENT**

1.6.8 **INSERT** one letter as follow:

<b>N</b>	if no <b>COM/NAV</b> /approach aid equipment for the route to be flown is carried, or the equipment is unserviceable, or
<b>S</b>	if standard <b>COM/NAV/</b> approach aid equipment for the route to be flown is carried and serviceable

1.6.9 **AND/OR INSERT** one or more of the following letters to indicate the **COM/NAV/** approach aid equipment available and serviceable:

<b>A</b>	LORAN A	<b>M</b>	Omega
<b>B</b>	(Not allocated)	<b>O</b>	VOR
<b>C</b>	LORAN C	<b>P</b>	Doppler
<b>D</b>	DME	<b>Q</b>	(Not allocated)
<b>E</b>	Decca	<b>R</b>	RNP type certification or RNAV route equipment
<b>F</b>	ADF	<b>T</b>	TACAN
<b>G</b>	GMSS (see note)	<b>U</b>	UHF RTF
<b>H</b>	HF RTF	<b>V</b>	VHF RTF
<b>I</b>	Inertial Navigation	<b>W</b>	when prescribed by ATS
<b>J</b>	Data link	<b>X</b>	
<b>K</b>	(Not allocated)	<b>Y</b>	
<b>L</b>	ILS	<b>Z</b>	Other equipment carried

### Notes

For flight planning purposes, standard COM/NAV equipment(s) is considered to be VHF RTF, ADF, Transponder Mode A or C, VOR, DME and ILS.

If the **Z** is used, specify in Item 18 the other equipment carried, preceded by **COM/** and/or **NAV/**, as appropriate.

If the letter **J** is used, specify in Item 18 the equipment carried, preceded by **DAT/** followed by one or more letters as appropriate. Refer to Item 18.

Information on navigation capability is provided to ATC for clearance and routing purposes.

Inclusion of the letter **R** indicates that an aircraft meets the RNP type prescribed for the route segment(s), route(s) or area concerned.

Inclusion of the letter **G** indicates that an aircraft meets the conditions and requirements for the use of GNSS (GPS or GLONASS) equipment.

**SSR EQUIPMENT**

1.6.10 **INSERT** one of the following to describe the serviceable SSR equipment carried:

<b>N</b>	Nil
<b>A</b>	Transponder — Mode A (4 digits — 4 096 codes)
<b>C</b>	Transponder — Mode A (4 digits — 4 096 codes) and Mode C
<b>X</b>	Transponder — Mode S without both aircraft identification and pressure-altitude transmission
<b>P</b>	Transponder — Mode S, including pressure-altitude transmission, but no aircraft identification transmission
<b>I</b>	Transponder — Mode S, including aircraft identification transmission, but no pressure-altitude transmission
<b>S</b>	Transponder — Mode S, including both pressure-altitude and aircraft identification transmission.

**ITEM 13: DEPARTURE AERODROME AND TIME (8 CHARACTERS)**

(a) **INSERT** the ICAO four-letter location indicator of the departure aerodrome,

**OR,**

(b) if no location indication has been assigned, **INSERT ZZZZ** and **SPECIFY**, in Item 18, the name of the aerodrome preceded by **DEP/**.

**OR,**

(c) if the flight plan is received from an aircraft in flight, **INSERT AFIL**, and **SPECIFY**, in Item 18, the ICAO four-letter location indicator of the location of the ATS unit from which supplementary flight plan data can be obtained, preceded by **DEP/**.

**THEN WITHOUT A SPACE,**

(d) **INSERT** for a flight plan submitted before departure, the estimated off-block time,

**OR,**

(e) for a flight plan received from an aircraft in flight, the actual or estimated time over the first point of the route to which the flight plan applies.

**ITEM 15: ROUTE**

1.6.11 **INSERT** the first cruising speed as in (a)(i) and the flight cruising level as in (d)(i), without a space between them.

**THEN,**

(a) following the arrow, **INSERT** the route description as in (i).

(i) **CRUISING SPEED (MAXIMUM 5 CHARACTERS)**

(b) **INSERT** the True Air Speed for the first or the whole cruising portion of the flight, in terms of:

(c) Knots, expressed as **N** followed by 4 figures (e.g. N0485),

**OR** (for oceanic flights)

(d) Mach number to the nearest hundredth of unit Mach, expressed as **M** followed by 3 figures (e.g. M082).

(i) **CRUISING LEVEL (MAXIMUM 5 CHARACTERS)**

(e) **INSERT** the planned cruising level for the first or the whole portion of the route to be flown, in terms of:

(f) Flight level, expressed as **F** followed by 3 figures (e.g. F085; F330),

**OR**

(g) Altitude in hundreds of feet, expressed as **A** followed by 3 figures (e.g. A045; A100),

**OR**

(h) For uncontrolled VFR flights, the letters VFR.

(i) **ROUTE (INCLUDING CHANGES OF SPEED, LEVEL AND/OR FLIGHT RULES)**

*FLIGHTS ALONG DESIGNATED ATS ROUTES*

- (a) **INSERT**, if the departure aerodrome is located on, or connected to the ATS route, the designator of the first ATS route,
- OR**,
- (b) if the departure aerodrome is not on, or connected to the ATS route, the letters **DCT** followed by the point of joining the first ATS route, followed by the designator of the ATS route.
- OR**
- (c) all reporting points on the ATS route if there is no ATS route designator.
- (d) **THEN INSERT** each point at which either a change of speed or level, a change of ATS route, and/or a change of flight rules is planned.

**Note**

When a transition is planned between a lower and upper ATS route and the routes are oriented in the same direction, the point of transition need not be inserted.

- (e) **FOLLOWED IN EACH CASE** by the designator of the next ATS route segment, even if the same as the previous one,
- OR**
- (f) by **DCT**, if the flight to the next point will be outside a designated route, unless both points are defined by geographical co-ordinates.

*FLIGHT OUTSIDE DESIGNATED ATS ROUTES*

- (g) **INSERT** points normally not more than 30 minutes flying time or 370km (200NM) apart, including each point at which a change of speed or level, a change of track, or a change of flight rules is planned.
- OR**
- (h) **DEFINE** the track of flights operating predominantly in an east-west direction between 70°N and 70°S by reference to significant points formed by the intersections of half or whole degrees of latitude with meridians spaced at intervals of 10 degrees of longitude. For flights operating in areas outside those latitudes the tracks must be defined by significant points formed by the intersection of parallels of latitude with meridians normally spaced at 20 degrees of longitude. The distance between significant points must, as far as possible, not exceed one hour's flight time. Additional significant points will be established as deemed necessary.



- (i) For flights operating predominantly in a north-south direction, define tracks by reference to significant points formed by the intersection of whole degrees of longitude with specified parallels of latitude which are spaced at 5 degrees.
- (j) **INSERT DCT** between successive points unless both points are defined by geographical co-ordinates or by bearing and distance.
- (k) **USE ONLY** the conventions in (i) to (i) below and **SEPARATE** each sub-item by a space.
  - (i) **ATS ROUTE (2 TO 7 CHARACTERS)**
  - (l) The coded designator assigned to the route segment including, where appropriate, the coded designator assigned to the standard departure or arrival route (e.g. BCNI, BI, R14, UB10, KODAP2A).
    - (i) **SIGNIFICANT POINT (2 TO 11 CHARACTERS)**
  - (m) The coded designator (2 to 5 characters) assigned to the point (e.g. WG, MAY, HADDY), or, if no coded designator has been assigned, one of the following ways:

*Degrees only (7 characters)*

1.6.12 2 figures describing altitude in degrees, followed by "N" (North) or "S" (South), followed by 3 figures describing longitude in degrees, followed by "E" (East) or "W" (West). Make up the correct number of figures, where necessary, by insertion of zeros, e.g. 46S078W.

*Degrees and minutes (11 characters)*

1.6.13 4 figures describing latitude in degrees and tens and units of minutes followed by "N" (North) or "S" (South), followed by 5 figures describing longitude in degrees and tens and units of minutes, followed by "E" (East) or "W" (West). Make up the correct number of figures, where necessary, by insertion of zeros, e.g. 4620S07805W.

*Bearing and distance from a navigation aid*

1.6.14 The identification of the navigation aid (normally a VOR), in the form of 2 or 3 characters, **THEN** the bearing from the aid in the form of 3 figures giving degrees magnetic, **THEN** the distance from the aid in the form of 3 figures expressing nautical miles. Make up the correct number of figures, where necessary, by insertion of zeros — e.g. a point 180° magnetic at a distance of 40NM from VOR VLI should be expressed as VLI180040.

- (i) **CHANGE OF SPEED OR LEVEL (MAXIMUM 21 CHARACTERS)**

1.6.15 The point at which a change of speed (5% TAS or 0.01 Mach or more) or a change of level is planned, expressed exactly as in (i) above, followed by an oblique stroke and both the cruising speed and the cruising level, expressed exactly as in (i) and (i) above, without a space between them, even when only one of these quantities will be changed.

<b>EXAMPLES</b>
LN/N0284A045
MAY/N0305F180
HADDY/N0420F330
4602S07805W/N0500F350
46S078W/M082F330
DUB180040/N0350M0840

(ii) **CHANGE OF FLIGHT RULES (MAXIMUM 3 CHARACTERS)**

1.6.16 The point at which the change of flight rules is planned, expressed exactly as in (i) or (i) above as appropriate, followed by a space and one of the following:

- (a) VFR if from IFR to VFR
- (b) IFR if from VFR to IFR

<b>EXAMPLES</b>
LN VFR
LN/N0284A050 IFR

(i) **CRUISE CLIMB (MAXIMUM 28 CHARACTERS)**

1.6.17 The letter **C** followed by an oblique stroke; **THEN** the point at which cruise climb is planned to start, expressed exactly as in (i) above, or the level above which cruise climb is planned followed the letters **PLUS**, without a space between them.

<b>EXAMPLES</b>
C/48N050W/M082F290F350
C/48N050W/M082F290PLUS
C/52N050W/M220F580F620

**ITEM 16: DESTINATION AERODROME AND TOTAL ESTIMATED ELAPSED TIME, ALTERNATE AERODROME(S)****DESTINATION AERODROME AND TOTAL ESTIMATED ELAPSED TIME (8 CHARACTERS)**

(a) **INSERT** the ICAO four-letter location indicator of the destination aerodrome followed, without a space, by the total estimated elapsed time,

**OR**, if no location indicator has been assigned,

(b) **INSERT ZZZZ** followed, without a space, by the total estimated elapsed time, and **SPECIFY** in Item 18 the name of the aerodrome, preceded by **DEST/**.

**Note**

1.6.18 For a flight plan received from an aircraft in flight, the total estimated elapsed time is the estimated time from the point of the route to which the flight plan applies.

**ALTERNATE AERODROME(S) (4 CHARACTERS)**

(a) **INSERT** the ICAO four-letter location indicator(s) of not more than two alternate aerodromes, separated by a space,

(b) **OR**, if no location indicator has been assigned to the alternate aerodrome,

(c) **INSERT ZZZZ** and **SPECIFY** in Item 18 the name of the aerodrome, preceded by **ALTN/**.

**Note**

1.6.19 Provision must be made for an alternative aerodrome(s) for IFR flight when the MET forecasts relating to the intermediate and terminal aerodromes specified in the flight plan indicate that, at the expected time of arrival at these aerodromes, the MET conditions will be:

(a) **CLOUD** ceiling less than 1,000ft above the minima specified for landing.

(b) **VISIBILITY** less than 5km.

1.6.20 If the MET conditions at an intermediate or destination aerodrome are such that nomination of an alternate is required, then the MET forecast for the alternate at the ETA must not be below the published alternate minima.

**ITEM 18: OTHER INFORMATION**

(a) **INSERT 0** (zero) if no other information,

**OR**

(b) any other necessary information in the preferred sequence shown below, in the form of the appropriate indicator followed by an oblique stroke and the information to be recorded:

<b>EET/</b>	Significant points or FIR boundary designators and accumulated estimated elapsed times to such points or FIR boundaries. e.g. <b>EET/GULANO204</b>
<b>REG/</b>	The registration markings of the aircraft, if different from the aircraft identification in Item 7.
<b>SEL/</b>	<b>SELCAL</b> code for oceanic flights.
<b>OPR/</b>	Name of the operator, if not obvious from the aircraft identification in Item 7.
<b>STS/</b>	Reason for special handling by ATS, e.g. <b>STS/HOSP</b> (hospital aircraft), <b>STS/ONE ENG INOP</b> (one engine inoperative) For domestic use, <b>STS/PHOT</b> (photography), and <b>STS/T</b> (IFR training), and <b>STS/T4A</b> (IFR training — four approaches) may also be used.
<b>TYP/</b>	Type(s) of aircraft, preceded if necessary by number(s) of aircraft, if <b>ZZZZ</b> is inserted in Item 9.
<b>COM/</b>	any deviation from minimum COM requirements.
<b>NAV/</b>	<b>"AUSEP"</b> if ausep equipped and flight planning into Nadi or Sydney OCA.
<b>DEP/</b>	Name of departure aerodrome, if <b>ZZZZ</b> is inserted in Item 13. ICAO four-letter location indicator of the location of the ATS unit from which supplementary flight plan data can be obtained, if AFIL is inserted in Item 13.
<b>DEST/</b>	Name of destination aerodrome, if <b>ZZZZ</b> is inserted in Item 16.
<b>ALTN/</b>	Name of alternate aerodrome(s), if <b>ZZZZ</b> is inserted in Item 16.
<b>RMK/</b>	Any other plain language remarks.

**ITEM 19: SUPPLEMENTARY INFORMATION***ENDURANCE*

<b>AFTER E/</b>	<b>INSERT</b> a 4-figure group giving the fuel endurance in hours and minutes.
-----------------	--

*PERSONS ON BOARD*

<b>AFTER P/</b>	<b>INSERT</b> the total number of persons (passengers and crew) on board if known.
-----------------	--

**EMERGENCY AND SURVIVAL EQUIPMENT**

<b>R/</b>	<p><b>(RADIO)</b>  <b>CROSS OUT U</b> if UHF on frequency 243.0 MHz is not available.  <b>CROSS OUT V</b> if VHF on frequency 121.5 MHz is not available.  <b>CROSS OUT E</b> If emergency location beacon — aircraft (ELBA) is not available.</p>
<b>S/</b>	<p><b>(SURVIVAL EQUIPMENT)</b>  <b>CROSS OUT</b> all indicators if survival equipment is not carried.  <b>CROSS OUT P</b> if polar survival equipment is not carried.  <b>CROSS OUT D</b> if desert survival equipment is not carried.  <b>CROSS OUT M</b> if maritime survival equipment is not carried.  <b>CROSS OUT J</b> if jungle survival equipment is not carried.</p>
<b>J/</b>	<p><b>(JACKETS)</b>  <b>CROSS OUT</b> all indicators if life jackets are not carried.  <b>CROSS OUT L</b> if life jackets are not equipped with lights.  <b>CROSS OUT F</b> if life jackets are not equipped with fluorescein.  <b>CROSS OUT U</b> or <b>V</b> or both as in <b>R/</b> above to indicate radio capability of jackets, if any.</p>
<b>D/</b>	<p><b>(DINGHIES) (NUMBER)</b>  <b>CROSS OUT</b> indicators <b>D</b> and <b>C</b> if no dinghies are carried, or  <b>INSERT</b> number of dinghies carried; and  <b>(CAPACITY)</b>  <b>INSERT</b> total capacity, in persons, of all dinghies carried; and,  <b>(COVER)</b>  <b>CROSS OUT</b> indicator <b>C</b> if dinghies are not covered; and  <b>(COLOUR)</b>  <b>INSERT</b> colour of dinghies if carried.</p>
<b>A/</b>	<p><b>(AIRCRAFT COLOUR AND MARKINGS)</b>  <b>INSERT</b> colour of aircraft and significant markings.</p>
<b>N/</b>	<p><b>(REMARKS)</b>  <b>CROSS OUT</b> indicator <b>N</b> if no remarks,  or <b>INDICATE</b> any other survival equipment carried and any other remarks regarding survival equipment.</p>
<b>C/</b>	<p><b>(PILOT)</b>  <b>INSERT</b> name of pilot-in-command.</p>

**FILED BY**

1.6.21 **INSERT** name of the unit, agency or person filing the flight plan.

## **2 REPETITIVE FLIGHT PLAN SYSTEM**

### **2.1 General**

2.1.1 The procedures concerning the use of Repetitive Flight Plans (RPL) conform to ICAO Doc 7030 and the PANS-RAC, Doc 4444, Appendix 2.

2.1.2 Repetitive flight plan lists relating to flights within Cook Islands shall be submitted to the Rarotonga ATS Unit — AIS Briefing Unit at least 14 days in advance, in duplicate, to the following address:

*(Address to be inserted)*

2.1.3 Repetitive flight plans shall not be used until the operator has been advised by the AIS Unit in writing that the plans are “approved for use”.

## **3 CHANGES TO THE SUBMITTED FLIGHT PLAN**

### **3.1 General**

3.1.1 No deviation may be made from a submitted flight plan without ATS being informed. In the case of a controlled flight, the prior approval of ATS must be obtained for any deviation unless an emergency situation arises which necessitates immediate action by the pilot-in-command. ATS is to be notified of such action as soon as circumstances permit.

3.1.2 In the event of a delay in departure of more than 30 minutes, the ATS received the flight plan, ATS must be advised of the new ETD. This applies to all flights for which flight plan data has been submitted and includes flights operating on repetitive flight plan. If an amended ETD is not received for a delayed flight, there is a possibility the flight plan may be automatically cancelled by another ATS unit utilising a flight planning computer system, e.g. a flight planned from Cook Islands to New Zealand.

3.1.3 Where no ETD is filed for the second or subsequent stage of the flight, pilots are to report arrival to ATS as soon as possible after landing. The next stage of the flight plan will not become active until an ETD or taxiing report is received. When an ETD has been notified to ATS the pilot shall advise ATS of any delay in departure of more than 30 minutes in order to avoid initiating SAR action unnecessarily. Where communications are known or expected to be difficult and/or ETD is uncertain, a SARTIME may be used.

**Notes**

SARTIME is the time nominated by the pilot for the initiation of alerting action if a report has not been received by that time.

When a VFR flight plan with intermediate landings has been submitted and cumulative delays are such that the ETA at final destination given in the flight plan will be exceeded by more than 30 minutes, the pilot-in-command is required to advise ATS and must amend the flight plan accordingly. In addition the pilot-in-command must, if practicable, advise ATS whenever the ETA shown on the flight plan for any specific route sector is likely to be exceeded by more than 30 minutes.

Whenever a flight, for which a flight plan has been submitted, is cancelled, Rarotonga ATS shall be informed immediately.

When a controlled flight inadvertently deviates from its current flight plan the pilot-in-command must take the following action:

- (a) Deviation from track — immediately advise ATS and take action to regain track as soon as practicable and at least by the next compulsory reporting point;
- (b) Change in ETA at next reporting point, level or radio navigation aid by 3 minutes or more from that previously notified: advise ATS of revised ETA as soon as possible.



## **4 ARRIVAL REPORT (TERMINATING A FLIGHT PLAN)**

### **4.1 General**

4.1.1 A report of arrival shall be made at the earliest possible moment after landing to Rarotonga Tower ATS by any flight for which a flight plan has been submitted except when the arrival has been acknowledged by the local ATS unit. After landing at an aerodrome which is not the destination aerodrome (diversionary landing), the local ATS unit shall be specifically informed accordingly.

4.1.2 In the absence of a local ATS unit at the aerodrome of a diversionary landing, the pilot is responsible for passing the arrival report to Rarotonga Tower ATS.

4.1.3 Arrival reports shall contain the following elements of information:

- (a) aircraft identification
- (b) departure aerodrome
- (c) destination aerodrome
- (d) time of arrival

4.1.4 In the case of diversion, insert the "arrival aerodrome" between "destination aerodrome" and "time of arrival".

# **Intentionally Blank**

## ENR 1.11 ADDRESSING OF FLIGHT PLAN MESSAGES

### 1 GENERAL

#### 1.1 Flight Movement Messages

1.1.1 Flight movement messages relating to traffic into or via the Cook Islands Sector of the Auckland FIR shall be addressed as shown in [Table ENR 1.11 - 1](#) in order to warrant correct relay and delivery.

#### **Note**

Flight movement messages in this context comprise flight plan messages, amendment messages relating thereto and flight plan cancellation messages (refer to ICAO PANS-RAC, Doc 4444, Part VIII, 2.1.1.3).

**Table ENR 1.11 - 1**  
**Flight Movement Messages**

CATEGORY OF FLIGHT (IFR, VFR or both)	ROUTE (into or via FIR and/or TMA)	MESSAGE ADDRESS
All flights		

# **Intentionally Blank**

## ENR 1.12 INTERCEPTION OF CIVIL AIRCRAFT

### 1 VISUAL SIGNALS FOR USE BY INTERCEPTING AND INTERCEPTED AIRCRAFT

#### 1.1 General

1.1.1 The code of visual signals for use by intercepting and intercepted aircraft is in the form of five standard series and a sixth “distress” series. When an intercepting aircraft wishes to lead an intercepted aircraft away from a particular area (such as a prohibited area) and then release it, the FIRST (follow me) and SECOND (you may proceed) series of signals will be used. When an aircraft has been intercepted purely for identification purposes, the intercepting aircraft will indicate that the intercepted aircraft is free to proceed by using the SECOND series of signals.

1.1.2 Should an intercepting aircraft require a landing at a designated aerodrome, or if an intercepting aircraft has come to lead a lost aircraft to an aerodrome it would first signal the FIRST series (follow me). Upon arriving in the vicinity of the aerodrome the intercepting aircraft would signal the THIRD series (land at this aerodrome). Should the intercepted aircraft find, after following the intercepting aircraft to an aerodrome, that it is of insufficient size or that, to the knowledge of the pilot-in-command, it has insufficient runway strength to support the load which a landing would impose, the intercepted aircraft will signal the FOURTH (aerodrome is inadequate) or FIFTH (cannot comply) series.

1.1.3 The signals used are shown in [Table ENR 1.12 - 1](#) and [Table ENR 1.12 - 2](#).

## 2 SIGNALS INITIATED BY INTERCEPTING AIRCRAFT AND RESPONSES BY INTERCEPTED AIRCRAFT

### 2.1 General

2.1.1 Table ENR 1.12 - 1 list the signals initiated by intercepting aircraft and responses by intercepted aircraft.

**Table ENR 1.12 - 1**  
**Signals Initiated by Intercepting Aircraft and Responses by Intercepted Aircraft**

SERIES	INTERCEPTING AIRCRAFT SIGNALS	MEANING	INTERCEPTED AIRCRAFT RESPONDS	MEANING
1	DAY or NIGHT Rocking aircraft and flashing navigational lights at irregular intervals from a position slightly above and ahead of, and normally to the left of, the intercepted aeroplane (or to the right of an intercepted helicopter) and, after acknowledgement, a slow level turn, normally to the left, in the case of an aeroplane (or to the right in the case of a helicopter) on to the desired heading.	You have been intercepted. Follow me.	DAY or NIGHT Rocking aircraft, flashing navigational lights at irregular intervals and following.  Note Additional action required to be taken by intercepted aircraft is prescribed in Series 4, 5, and 6.	Understood, will comply.
<p><b>Notes</b> Meteorological conditions or terrain may require the intercepting aircraft to reverse the positions and direction of turn given above in Series 1.</p> <p>If the intercepted aircraft is not able to keep pace with the intercepting aircraft, the latter is expected to fly a series of race-track patterns and to rock the aircraft each time it passes the intercepted aircraft.</p>				

SERIES	INTERCEPTING AIRCRAFT SIGNALS	MEANING	INTERCEPTED AIRCRAFT RESPONDS	MEANING
2	DAY or NIGHT An abrupt break-away manoeuvre from the intercepted aircraft consisting of a climbing turn of 90 degrees or more without crossing the line of flight of the intercepted aircraft.	You may proceed.	DAY or NIGHT Rocking the aircraft.	Understood, will comply.
3	DAY or NIGHT Lowering landing gear (if fitted), showing steady landing lights and overflying runway-in-use or, if the intercepted aircraft is a helicopter, landing area. In the case of helicopters, the intercepting helicopter makes a landing approach, coming to hover near to the landing area.	Land at this aerodrome	DAY or NIGHT Lowering landing gear, (if fitted), showing steady landing lights and following the intercepting aircraft and, if , after overflying the runway-in-use or helicopter landing area, landing is considered safe, proceeding to land.	Understood, will comply.
4	DAY or NIGHT Raising landing gear (if fitted) and flashing landing lights while passing over runway-in-use or helicopter landing area at a height exceeding 1000ft but not exceeding 2000ft above the aerodrome level, and continuing to circle the runway-in-use or helicopter landing area. If unable to flash landing lights, flash any other lights available.	Aerodrome you have designated is inadequate	DAY or NIGHT If it is desired that the intercepted aircraft follow the intercepting aircraft to an alternate aerodrome, the intercepting aircraft raises its landing gear (if fitted) and uses the Series 1 signals prescribed for intercepting aircraft.  If it is decided to release the intercepted aircraft, the intercepting aircraft uses the Series 2 signals prescribed for intercepting aircraft.	Understood, follow me.  Understood, you may proceed.
5	DAY or NIGHT Regular switching on and off of all available lights but in such a manner as to be distinct from flashing lights.	Cannot comply.	DAY or NIGHT Use Series 2 signals prescribed for intercepting aircraft.	Understood.
6	DAY or NIGHT Irregular flashing of all available lights.	In distress.	DAY or NIGHT Use Series 2 signals prescribed for intercepting aircraft.	Understood.

# **Intentionally Blank**



## **ENR 1.13 UNLAWFUL INTERFERENCE**

### **1 GENERAL**

#### **1.1 Introduction**

1.1.1 The following procedures are intended for use by aircraft when unlawful interference occurs and the aircraft is unable to notify an ATS unit of this fact.

### **2 PROCEDURES**

#### **2.1 Introduction**

2.1.1 Unless considerations aboard the aircraft dictate otherwise, the pilot-in-command should attempt to continue flying on the assigned track and at the assigned cruising level at least until notification to an ATS unit is possible or the aircraft is within radar coverage.

2.1.2 When an aircraft subjected to an act of unlawful interference must depart from its assigned track or its assigned cruising level without being able to make radiotelephony contact with ATS, the pilot-in-command should, whenever possible:

- (a) attempt to broadcast warnings on the VHF emergency frequency and other appropriate frequencies, unless considerations aboard the aircraft dictate otherwise. Other equipment such as onboard transponders, data links, etc. should also be used when it is advantageous to do so and circumstances permit; and
- (b) if no applicable regional procedures have been established, proceed at a level which differs from the cruising levels normally used for IFR flight in the area by 1,000ft if above FL290 or 500ft if below FL290.

# **Intentionally Blank**

## ENR 1.14 AIR TRAFFIC INCIDENTS

### 1 AIR SAFETY INCIDENTS

#### 1.1 General

1.1.1 ATS Units will complete Air Safety Incidents report form and forward to the address as follows:

Secretary for Transport  
Ministry of Transport  
PO Box 61  
Rarotonga  
COOK ISLANDS

TEL (682) 28 810

FAX (682) 28 816

AFTN NCRGYAYX

### 2 AVIATION SAFETY REPORT

#### 2.1 General

2.1.1 Whenever possible an initial report of an air safety incident of major significance occurring during flight must be transmitted to the ATS unit or to the air-ground control radio station with which the aircraft is in communication at the time. Such reports are to contain the following information as applicable:

- (a) type of incident, i.e. near collision/procedures;
- (b) radio callsign of aircraft making the report;
- (c) position, heading or route, true airspeed or Mach number;
- (d) flight level, altitude or height and aircraft attitude;
- (e) IMC or VMC;
- (f) time of incident;
- (g) description of other aircraft if applicable;
- (h) brief details of incident including, when appropriate, sighting distance and miss distance.

2.1.2 The pilot-in-command must, if involved in an incident, submit a completed aviation safety report to the nearest ATS unit, as soon as possible but not later than 24 hours after landing to:

- (a) confirm an initial report made by radio; or
- (b) make an initial report on an incident if it had not been possible to report it by radio.

2.1.3 The ATS unit receiving the report is responsible for advising other ATS units and/or pilots involved.

2.1.4 The purpose of the air safety incident report is to provide investigatory authorities with as much information on an air safety incident as is possible and to enable them to report back with the least possible delay to the pilot or operator concerned the result of the investigation of the incident and, if appropriate, the remedial action taken.

### **3 FACILITY MALFUNCTION REPORTING**

#### **3.1 General**

3.1.1 Facility malfunction reporting is an important component of aviation safety and, to be effective, requires both prompt action and whole hearted co-operation of all parties. In order that the report may be investigated thoroughly, it is necessary that relevant details be provided as soon as possible.

3.1.2 Each pilot-in-command of an aircraft operating IFR must, after observing a malfunction of any aeronautical telecommunications facility forward a report to the Safety Office as soon as possible after landing. The pilot-in-command should:

- (a) Pass brief details of the malfunction to the ATS unit or air-ground station with which the aircraft is in communication at the time, and
- (b) Include the following information:
  - (i) aircraft type; and
  - (ii) aircraft registration and, if applicable, the flight number; and
  - (iii) name of pilot-in-command; and
  - (iv) name of the operator; and
  - (v) aircraft position and altitude; and
  - (vi) phase of flight; and
  - (vii) facility affected; and
  - (viii) brief details of the malfunction; and
  - (ix) effect on the flight.

## ENR 1.15 EMERGENCY PROCEDURES

### 1 DISTRESS

#### 1.1 Definition

1.1.1 Distress is defined as a condition of being threatened by serious and/or imminent danger and requiring immediate assistance.

#### 1.2 Transmission of MAYDAY Message

1.2.1 The pilot of an aircraft in distress must transmit on the air-ground frequency in use at the time of the distress the distress signal MAYDAY (preferably spoken three times), followed by the distress message.

1.2.2 If on an unattended frequency and it is considered that better assistance can be provided by transferring to another frequency the pilot should do so, after broadcasting this intention on the original frequency.

#### 1.3 Content of MAYDAY Message

1.3.1 The distress message should consist of as many of the following elements spoken distinctly and if possible, in the following order:

- (a) name of station addressed (time and circumstances permitting);
- (b) identification of the aircraft;
- (c) nature of the distress condition;
- (d) intention of the pilot; and
- (e) present position, level (FL or altitude), and heading.

1.3.2 The transmission of an accurate aircraft position may be critical to any subsequent search and/or rescue action.

1.3.3 In addition the pilot should:

- (a) activate the ELT;
- (b) if the emergency situation is recovered, turn the ELT off and advise ATC or RCCNZ as soon as possible;
- (c) if the ELT is turned off and ATC or RCCNZ are not advised as soon as possible, it will be assumed that the aircraft has crashed and search planning will have commenced.

## **2 URGENCY**

### **2.1 Definition**

2.1.1 Urgency is defined as a condition concerning the safety of an aircraft, or of some person on board or within sight, but which does not require immediate assistance.

### **2.2 Transmission of PAN PAN Message**

2.2.1 The pilot of an aircraft reporting an urgency condition must transmit on the air-ground frequency in use at the time the urgency signal PAN PAN (preferably spoken three times), followed by the urgency message.

### **2.3 Content of PAN PAN Message**

2.3.1 The urgency message should consist of as many of the following elements spoken distinctly and if possible, in the following order:

- (a) name of station addressed;
- (b) identification of the aircraft;
- (c) nature of the urgency condition;
- (d) intention of the pilot;
- (e) present position, level (FL or altitude), and heading; and
- (f) any other useful information.

### **3 COMMUNICATIONS FAILURE**

#### **3.1 ATS Communications Failure**

3.1.1 In the event of communications failure from ATS, the pilot of an aircraft should initiate TIBA procedures as detailed in Section 7 of ENR 1.15.

#### **3.2 IFR Communications Failure — General**

3.2.1 In the event of an apparent aircraft communication failure, the pilot of the aircraft should adopt the following procedures:

- (a) Maintain terrain clearance throughout all procedures.
- (b) Try alternate then secondary published ATS frequencies.
- (c) Check aircraft communications equipment.
- (d) Listen out on interpilot VHF frequency.
- (e) Transmit position reports and intentions, assuming the aircraft transmitter is operating, and prefixing all transmissions with "TRANSMITTING BLIND".
- (f) Turn on landing lights, beacons and strobes when entering controlled airspace or joining the aerodrome traffic circuit.
- (g) If a mobile telephone is available in the aircraft, attempt to establish telephone communications with
  - Rarotonga Tower (00682) 25896 or (00682) 25890 ext 213 or
  - Manager Air Traffic Services (00682) 71439.

#### **3.3 IFR Communications Failure — VMC and Certain of Maintaining VMC**

3.3.1 If the pilot of the aircraft is in VMC, or encounters VMC after the failure, and is certain of maintaining VMC:

- (a) remain in VMC; and
- (b) continue the flight under VFR; and
- (c) proceed to a suitable aerodrome and land; and
- (d) report arrival by the most expeditious means to the appropriate ATS unit.

**3.4 IFR Communications Failure — IMC or Uncertain of Maintaining VMC**

3.4.1 The initial and subsequent actions of the pilot of an aircraft in IMC or uncertain of being able to maintain VMC will depend on the latest information available on the:

- (a) destination aids;
- (b) air traffic/airspace procedures; and
- (c) meteorological conditions enroute and at the destination.

3.4.2 The provision of ATC to other flights will be based on the assumption that the pilot of an aircraft with communications difficulties will, unless strong reasons dictate otherwise, follow the appropriate procedures specified in paragraphs 3.4.3 to 3.4.9.

3.4.3 The pilot should proceed in accordance with the current flight plan as confirmed by the last acknowledged ATC clearance. ATC will assume that the aircraft will climb to the:

- (a) flight planned level; or
- (b) last level requested by the pilot and acknowledged by ATC.

***Departure — Level Restriction***

3.4.4 The pilot of an IFR aircraft that experiences communications failure on departure should:

- (a) Maintain that last assigned level(s) to the points specified, then climb to maintain the level(s) in the current flight plan; or
- (b) If no points are specified, maintain the last assigned level, or minimum flight altitude if higher, for five minutes, then climb to maintain the level(s) specified in the current flight plan.

***Arrival***

3.4.5 On arrival, the pilot of an IFR aircraft experiencing communications failure should:

- (a) Track to the destination aid/fix, or if none specified by ATC, the selected aid/fix for the known or forecast RWY; and
- (b) If in receipt of an arrival clearance (STAR or equivalent clearance/procedure), track via the clearance; and
- (c) Commence descent to the initial approach altitude for the approach procedure in accordance with the last acknowledged ATC clearance and then the standard operating procedures (i.e. 3° profile) or flight plan.



***At or Within 25 NM from Destination***

3.4.6 At or within 25 NM from destination, the pilot of an IFR aircraft experiencing communications failure should:

- (a) Arrive over the destination/selected aid/fix at the last assigned level at or as near as possible to the expected approach time given by ATC, and commence approach; or
- (b) If too high, descend in the aid/fix holding pattern to a level convenient for approach; or
- (c) If on initial approach at the time of the communications failure but not cleared for the approach, continue via the procedure and maintain the last assigned level until established on final approach track, then commence approach; or
- (d) If too high:
  - (i) if a holding pattern is established on the final approach track, descend in the holding pattern to a level convenient for approach; or
  - (ii) if no holding pattern is established, carry out missed approach and position for another approach, if specified diversion allows.

***Diversion***

3.4.7 If unable to achieve a landing following an approach, the pilot of an IFR aircraft that experiences communications failure should carry out a missed approach.

3.4.8 A second approach may be made if desired, provided a landing can be accomplished within 30 minutes of the expected approach time or the ETA, whichever is the latter. If this approach is unsuccessful, the aircraft must divert to the alternate aerodrome.

3.4.9 The pilot of an IFR aircraft that experiences communications failure while holding because of the closure of the destination aerodrome should hold until the divert time notified to ATC, and then depart for the alternate aerodrome.

## **4 VFR COMMUNICATIONS FAILURE**

### **4.1 ATS Communications Failure**

4.1.1 In the event of an ATS communications failure, the pilot of a VFR aircraft in controlled airspace should initiate TIBA procedures as detailed in section 7 of ENR 1.15.

### **4.2 VFR Communications Failure**

4.2.1 In the event of an apparent aircraft communication failure, the pilot of the aircraft should adopt the following procedures:

- (a) Maintain terrain clearance throughout all procedures.
- (b) Try alternate then secondary published ATS frequencies for the sector or unit you should be in communication with.
- (c) Check aircraft communications equipment.
- (d) Listen out on interpilot VHF frequency.
- (e) Transmit position reports and intentions, assuming the aircraft transmitter is operating, and prefixing all transmissions with "TRANSMITTING BLIND".
- (f) Turn on landing lights, beacons and strobes when entering controlled airspace or joining the aerodrome traffic circuit.
- (g) If a mobile telephone is available in the aircraft, attempt to establish telephone communications with
  - Rarotonga Tower (00682) 25896 or (00682) 25890 ext 213 or
  - Manager Air Traffic Services (00682) 71439.
- (h) Approach the aerodrome clear of the final approach areas and carry out a standard joining procedure.
- (i) Report your arrival to ATS as soon as possible.

## 5 SPEECHLESS TECHNIQUE USING UNMODULATED TRANSMISSIONS

### 5.1 General

5.1.1 When a pilot is able to communicate only by unmodulated transmissions (e.g. when the transmitter is operative but the microphone is unserviceable), the following technique will be employed by ATS:

- (a) when an unmodulated transmission is heard, the ATS operator will request the pilot activate the transmitter three times; and
- (b) if the pilot complies ATS will frame questions requiring "YES" or "NO" answers to determine if the aircraft:
  - (i) can continue visually; or
  - (ii) can execute an instrument approach, or has reached a nominated position.

5.1.2 This and any other information required will be obtained by requiring the pilot to use the following code:

- (a) "YES" or "ROGER" activate transmitter once
- (b) "NO" activate transmitter twice
- (c) "SAY AGAIN" activate transmitter 3 times
- (d) "AT NOMINATED POSITION" activate transmitter 4 times

5.1.3 When it is established that the pilot of the aircraft can receive transmissions, control will be exercised in the normal manner, except that frequency changes will not be requested unless there is no alternative.

## 6 AERODROME EMERGENCIES

### 6.1 Aerodrome Emergency Plan

6.1.1 The object of an aerodrome emergency plan is to prepare an aerodrome to cope with an emergency occurring on, or in the vicinity of the aerodrome. The plan sets forth the procedures for coordinating the response of different aerodrome services and those agencies in the surrounding community that could be of assistance in an emergency.

Examples of the types of emergencies are:

- (a) Aircraft malfunctions;
- (b) Sabotage, including bomb threats;
- (c) Unlawfully seized aircraft;
- (d) Dangerous goods occurrences; and
- (e) Building fires and natural disasters.

6.1.2 An aerodrome emergency plan exists at all aerodromes that have regular air transport services by aircraft with 30 or more passenger seats.

### 6.2 Procedures to Activate Aerodrome Emergency Services

6.2.1 The ATS unit on the aerodrome is responsible for alerting the emergency services, following a request from a pilot or when an aircraft is considered to be in any of the following emergency phases:

- (a) **Local Standby Phase:** when an aircraft approaching the aerodrome is known, or is suspected, to have developed some defect, but the trouble is not such as would normally prevent carrying out a safe landing. Declaration of the LOCAL STANDBY PHASE will bring all aerodrome-based emergency services to a state of readiness but in general, although off-aerodrome components are notified, they will remain at their posts.
- (b) **Full Emergency Phase:** when an aircraft approaching the aerodrome is, or is suspected to be, in such trouble that there is danger of an accident. Declaration of a FULL EMERGENCY PHASE will bring all facilities, both on the aerodrome and in the community, such as medical and ambulance services, police and fire services, to a rendezvous point on the aerodrome. It will also alert the hospital to prepare for possible reception of injured, and for road traffic control to be instituted along the route between the hospital and the aerodrome to clear the way for emergency vehicles.
- (c) **Aircraft Accident Phase:** when an aircraft accident has occurred on or in the vicinity of the airport. Declaration of the AIRCRAFT ACCIDENT PHASE will bring all facilities into immediate action.

6.2.2 When an emergency occurs in flight and adequate communications exist, the pilot is responsible for advising the ATS unit accordingly and for nominating the desired state of readiness of the aerodrome emergency services. If adequate communications with the aircraft do not exist, the ATS unit will assess the situation and bring the aerodrome emergency services to the state of readiness considered appropriate.

## **7 TRAFFIC INFORMATION BROADCASTS BY AIRCRAFT (TIBA)**

### **7.1 General**

7.1.1 TIBA are reports and information transmitted by pilots for the information of pilots of other aircraft in the vicinity following a significant disruption to air traffic or telecommunication services.

### **7.2 Degradation of the ATS system**

7.2.1 Pilots will as far as practicable be advised by ATS when the level of available communication is being reduced.

7.2.2 ATS have procedures outlining their response to events that may eventuate in a loss of communication. If the event (such as an evacuation of the ATSC or other ATS facility) is covered by such procedures ATS will, with due regard to their own safety and the nature of the event, issue instructions to facilitate a smooth transition to either:

- (a) Alternative communications; or
- (b) A TIBA environment.

### **7.3 Introduction and Applicability of TIBA**

7.3.1 TIBA will be introduced only when necessary and as a temporary measure. If circumstances permit, introduction of TIBA will be by NOTAM.

7.3.2 Pilots of aircraft should initiate TIBA when there is a complete failure of communication from ATC. The broadcast procedures should be applied in designated airspace where there is:

- (a) a need to supplement collision hazard information provided by air traffic services outside controlled airspace; or
- (b) a temporary disruption of normal air traffic services.

**7.4 VHF RTF Frequency to be used for TIBA**

7.4.1 Pilots are to use the Rarotonga ATS frequency of 118.1 MHz.

**7.5 TIBA Listening Watch**

7.5.1 A listening watch should be maintained on the TIBA frequency 10 minutes before entering TIBA airspace until leaving that airspace. For an aircraft taking off from an aerodrome located within the lateral limits of TIBA airspace, listening watch should start as soon as appropriate prior to or after take-off.

7.5.2 Aircraft within the NZZO FIR should also make position reports to an alternative HF station.

**7.6 Timing of TIBA**

7.6.1 A broadcast should be made:

- (a) 10 minutes before entering TIBA airspace or, for a pilot taking off from an aerodrome located within the lateral limits of TIBA airspace, as soon as appropriate prior to or after take-off;
- (b) 10 minutes prior to, and crossing any reporting point;
- (c) at 10 minute intervals between reporting points;
- (d) 10 minutes prior to crossing or joining an ATS route;
- (e) where possible 2 to 5 minutes before a change in flight level or altitude;
- (f) at the time of a change in flight level or altitude;
- (g) when reaching new flight level or altitude; and
- (h) at any other time considered necessary by the pilot.

**7.7 Content of TIBA**

7.7.1 The information to be broadcast in a TIBA is detailed in Table ENR 1.15-1.

**7.8 Acknowledgement of TIBA**

7.8.1 The broadcasts should not be acknowledged unless a potential collision risk is perceived.

## **7.9 Changes of Cruising Level Under TIBA**

7.9.1 Cruising level changes should not be made within the designated airspace, unless considered necessary by pilots to avoid traffic conflicts, for weather avoidance, or for other valid operational reasons.

7.9.2 When cruising level changes are unavoidable, display all available aircraft lighting that would improve the visual detection of the aircraft while changing levels.

## **7.10 Collision Avoidance Under TIBA**

7.10.1 If, on receipt of a traffic information broadcast from another aircraft, a pilot decides that immediate action is necessary to avoid an imminent collision risk to their aircraft, and this cannot be achieved in accordance with the standard right-of-way provisions, the pilot should:

- (a) unless an alternative manoeuvre appears more appropriate, immediately descend 500 ft;
- (b) display all available aircraft lighting that would improve the visual detection of the aircraft;
- (c) as soon as possible, reply to the broadcast notifying action being taken on the appropriate TIBA frequency; and
- (d) as soon as practicable, resume normal flight level/altitude, notifying the action on the appropriate TIBA frequency.
- (e) Response to a system-initiated ACAS Resolution Advisory has precedence over the above instructions.

## **7.11 Normal Position Reporting Procedures Under TIBA**

7.11.1 Normal position reporting procedures should be continued at all times, regardless of any action taken to initiate or acknowledge a TIBA.

**Table ENR 1.15-1  
Information required in TIBA**

Content	Example
<b>Normal broadcast</b>	
ALL STATIONS (necessary to identify a traffic information broadcast)	<i>ALL STATIONS</i>
(callsign)	<i>E5-EFS</i>
FLIGHT LEVEL/ALTITUDE (number)	<i>13,000 FEET</i>
(or CLIMBING* TO FLIGHT LEVEL/ALTITUDE (number))	
(direction)	<i>NORTHBOUND</i>
(ATS route)	<i>DIRECT RG TO AI ON THE 347R RG</i>
(or DIRECT FROM (position) TO (position))	<i>VOR</i>
POSITION (position**) AT (time)	<i>POSITION 45DME RG</i>
ESTIMATING	<i>ESTIMATING AI AT 2115</i>
(next reporting point, or the point of crossing or joining a designated ATS route) AT (time)	
* This applies to an aircraft taking off from an aerodrome located within the lateral limits of the designated airspace.	
** For broadcasts made when the aircraft is not near an ATS significant point, the position should be given as accurately as possible and in any case to the nearest 30 minutes of latitude and longitude.	



<b>Content</b>	<b>Example</b>
<b>2 – 5 minutes prior to changing altitude/flight level</b>	
ALL STATIONS (callsign) (direction) (ATS route) (or DIRECT FROM position) TO (position))	<i>ALL STATIONS E5-EFS NORTHBOUND DIRECT RG TO AI ON THE 347R RG VOR</i>
LEAVING FLIGHT LEVEL/ALTITUDE (number)	<i>LEAVING 13,000 FEET</i>
FOR FLIGHT LEVEL/ALTITUDE (number)	<i>FOR 1500 FEET</i>
AT (position and time)	<i>AT 110DME RG AT 2105</i>
<b>At the time of a change in altitude/flight level</b>	
ALL STATIONS (callsign) (direction) (ATS route) (or DIRECT FROM (position) TO (position))	<i>ALL STATIONS E5-EFS NORTHBOUND DIRECT RG TO AI ON THE 347R RG VOR</i>
LEAVING FLIGHT LEVEL/ALTITUDE (number)	<i>LEAVING 13,000 FEET</i>
NOW FOR FLIGHT LEVEL/ALTITUDE (number)	<i>NOW FOR 1500 FEET</i>
<b>On reaching new altitude/flight level</b>	
ALL STATIONS (callsign) MAINTAINING FLIGHT LEVEL/ALTITUDE (number) NOW	<i>ALL STATIONS E5-EFS MAINTAINING 1500 FEET NOW</i>

# **Intentionally Blank**

# **ENR 2 AIR TRAFFIC SERVICES AIRSPACE**



## ENR 2.1 CTR, TMA, CTA

### 1 AREA OF RESPONSIBILITY

#### 1.1 General

1.1.1 The area of responsibility for providing air traffic services is the Cook Sector of the Auckland Oceanic FIR. The airspace and the services available within them are shown in [Table ENR 2.1-1](#).

1.1.2 The Rarotonga CTR and TMA are only active during the hours of service of Rarotonga ATC. Outside of these hours the entire Cook Sector is Class G and AFIS/FIS is provided. Refer to NOTAM for ATS hours of service.

**D**

**Table ENR 2.1 - 1  
Air Traffic Services and Airspace**

NAME	LATERAL LIMITS	UPPER LIMIT LOWER LIMIT	SERVICE LANGUAGE	ATS HOURS OF SERVICE	CALLSIGN ATS FREQ
<b>AUCKLAND OCEANIC FIR OCA/A</b>	Refer to CAA New Zealand Air Navigation Register <a href="http://www.caa.co.nz">www.caa.co.nz</a>	FL460 SFC	Auckland/ English	H24	Auckland Radio 3467, 5643, 8867, 13261, 17904
<b>COOK SECTOR G</b>	All that airspace bounded by a line joining S 05 00 00.0, W 157 00 00.0; S 23 00 00.0, W 157 00 00.0; S 23 00 00.0, W 173 26 30.0; S 18 35 00.0, W 169 00 00.0; S 15 52 00.0, W 170 00 00.0, the arc of a circle of 100 NM radius centred on S 14 19 57.3, W 170 42 29.3 (Pago Pago VORTAC) from S 15 52 00.0, W 170 00 00.0 anticlockwise to S 13 50 00.0, W 169 04 00.0, a line joining S 13 50 00.0, W 169 04 00.0; S 05 00 00.0, W 160 00 00.0; S 05 00 00.0, W 157 00 00.0.	FL245 SFC	Rarotonga/ English	NOTAM	Use "Rarotonga Tower" when ATC on watch. 3425, 6553, 8846, 11339 Use "Rarotonga Flight Service" when Flight Service on watch. 118.1 MHz 121.9 MHz (Standby)

**Table ENR 2.1 - 1**  
**Air Traffic Services and Airspace**

NAME	LATERAL LIMITS	UPPER LIMIT LOWER LIMIT	SERVICE LANGUAGE	ATS HOURS OF SERVICE	CALLSIGN ATS FREQ
<b>RAROTONGA CTA/C</b>	All that airspace bounded by the arc of a circle of 100 NM radius centred on S 18 49 29.3, W 159 46 24.4 (Aitutaki NDB) from S 18 46 19.2, W 161 30 24.0 clockwise to S 17 59 19.2, W 158 14 08.4, a line joining S 17 59 19.2, W 158 14 08.4; S 20 00 00.0, W 157 00 00.0; S 21 41 00.0, W 157 00 00.0; S 22 40 10.2, W 158 57 49.8, the arc of a circle of 100 NM radius centred on S 21 12 05.9, W 159 48 51.7 (Rarotonga VOR/DME) from S 22 40 10.2, W 158 57 49.8 clockwise to S 21 08 06.0, W 161 35 54.0, a line joining S 21 08 06.0, W 161 35 54.0; S 18 46 19.2, W 161 30 24.0.	<u>FL245</u> 14500	Rarotonga/ English	NOTAM	Use "Rarotonga Tower" when ATC on watch.  Use "Rarotonga Flight Service" when Flight Service on watch.
<b>RAROTONGA CTA/C</b>	All that airspace bounded by a circle of 70 NM radius centred on S 21 12 05.9, W 159 48 51.7 (Rarotonga VOR/DME).	<u>14500</u> 9500	Rarotonga/ English	NOTAM	118.1 MHz 121.9 MHz (Standby)
<b>RAROTONGA CTA/C</b>	All that airspace bounded by a circle of 50 NM radius centred on S 21 12 05.9, W 159 48 51.7 (Rarotonga VOR/DME).	<u>9500</u> 5500	Rarotonga/ English	NOTAM	

## **2 AIR TRAFFIC SERVICES**

### **2.1 General**

2.1.1 In general, the air traffic rules and procedures in force and the organisation of Air Traffic Services are in conformity with ICAO standards, recommended practices and procedures. The differences are given in [GEN 1.7](#).

## **3 SERVICE PROVIDED**

### **3.1 General**

3.1.1 The ATS provided comprises:

- (a) Air traffic control service to IFR flights in Class C airspace.
- (b) Air traffic control service to VFR flights in Class C airspace.
- (c) Air traffic control service to all aerodrome traffic at controlled aerodromes.
- (d) Flight Information Service to known flights in Class G airspace.

#### **Note**

Air traffic control service is provided for the purpose of preventing collisions and maintaining an orderly flow of traffic.

- (a) FIS for the purpose of giving advice and information useful for the safe and efficient conduct of flights.
- (b) Alerting service to all flights known to ATS for the purpose of initiating and/or assisting in search and rescue action.



### **3.2 Air Traffic Control (ATC)**

3.2.1 Air traffic control service comprises:

- (a) Approach control service provided by Rarotonga ATS unit during the hours of watch of Rarotonga Tower.
- (b) Aerodrome control service during the hours of watch of Rarotonga Tower.

### **3.3 Flight Information Service**

3.3.1 FIS will be provided whenever practicable to all aircraft known to be affected by the information.

3.3.2 In the case of aircraft in flight, flight information is normally confined to the route being flown.

#### **Notes**

FIS does not diminish the responsibilities normally vested in the pilot-in-command of an aircraft, including that for making a final decision regarding any suggested alteration to flight plan.

Where an ATC unit provides both FIS and ATC service, the provision of ATC service will take precedence over the provision of FIS whenever the provision of ATC service so requires.

FIS will include the provision of pertinent:

- (a) SIGMET information;
- (b) information on changes in the serviceability of radio navigation aids;
- (c) information on changes in conditions of aerodromes and associated facilities, and any other information likely to affect safety;
- (d) Traffic information in:
  - (i) Class C airspace, between VFR flights, together with traffic avoidance advice on request.
  - (ii) Class D airspace, to IFR flights with respect to VFR flights, and as far as practicable to VFR flights with respect to IFR and VFR flights.
  - (iii) Class G airspace, to IFR flights with respect to other IFR flights and as far as practicable to VFR flights with respect to IFR and VFR flights.
- (e) weather conditions reported or forecast at departure, destination, and enroute aerodromes.

3.3.3 Traffic information may also be provided by ATS, when it is apparent from pilot reports or observations that aircraft may be in proximity to each other.

**Note**

Traffic information comprises details of known aircraft which might constitute a collision hazard to the aircraft concerned and will sometimes be incomplete. ATS cannot accept responsibility for its issuance at all times or for its accuracy.

**3.4 Aerodrome Flight Information Service**

3.4.1 AFIS is the provision of information useful to pilots for the safe and efficient conduct of their flights. It differs from ATC service in that pilots being provided with AFIS have the responsibility of assessing a situation based on information passed to them by Flight Service, then advising their intentions. Other pilots in the vicinity hearing this exchange or RTF messages make their own decision and, in turn, make known their own intentions.

3.4.2 Outside the hours of watch of Air Traffic Control and during the hours of watch of Flight Service, an Aerodrome Flight Information Service, Area Flight Information Service and Alerting Service is provided by Rarotonga Flight Service.

## **ENR 2.2 OTHER REGULATED AIRSPACE**

### **1 OTHER AIRSPACE**

#### **1.1 General**

1.1.1 Nil.

# **Intentionally Blank**

## **ENR 3 ATS ROUTES**



## ENR 3.1 LOWER ATS ROUTES

### 1 INTRODUCTION

#### 1.1 General

1.1.1 Most commonly used routes are depicted on the AIP charts and include the following information:

- (a) radio facilities defining routes or used to determine reporting points
- (b) magnetic tracks, VOR radials and distances
- (c) minimum safe altitudes (MSA)
- (d) designated reporting points

#### 1.2 Reporting Points

1.2.1 Reporting points are depicted on Enroute Charts.

#### 1.3 Adherence to Track

1.3.1 Adherence to track must be maintained unless otherwise authorised or directed by ATC, flights must, so far as is practicable:

- (a) when on a promulgated route, operate along the centreline of the route; or
- (b) when on any other route, operate directly between the navigation facilities and/or points defining the route.

1.3.2 If a pilot deviates from the centreline of a route, or if the performance of the radio navigation facilities are such that accurate track keeping may not be possible, the pilot must immediately advise ATS.

1.3.3 Refer to CAA New Zealand Air Navigation Register [www.caa.govt.nz](http://www.caa.govt.nz) for information on ATS routes and reporting points.

# **Intentionally Blank**



## ENR 3.2 UPPER ATS ROUTES

### 1 INTRODUCTION

#### 1.1 General

1.1.1 Most commonly used routes are depicted on the AIP charts and include the following information:

- (a) radio facilities defining routes or used to determine reporting points
- (b) magnetic tracks, VOR radials and distances
- (c) minimum safe altitudes (MSA)
- (d) designated reporting points

#### 1.2 Reporting Points

1.2.1 Reporting points are depicted on Enroute Charts.

#### 1.3 Adherence to Track

1.3.1 Adherence to track must be maintained unless otherwise authorised or directed by ATC, flights must, so far as is practicable:

- (a) when on a promulgated route, operate along the centreline of the route; or
- (b) when on any other route, operate directly between the navigation facilities and/or points defining the route.

1.3.2 If a pilot deviates from the centreline of a route, or if the performance of the radio navigation facilities are such that accurate track keeping may not be possible, the pilot must immediately advise ATS.

1.3.3 Refer to CAA New Zealand Air Navigation Register [www.caa.govt.nz](http://www.caa.govt.nz) for information on ATS routes and reporting points.

# **Intentionally Blank**

## **ENR 3.3 AREA NAVIGATION ROUTES**

### **1 INTRODUCTION**

#### **1.1 General**

1.1.1 Nil.

# **Intentionally Blank**

## **ENR 3.4 HELICOPTER ROUTES**

### **1 INTRODUCTION**

#### **1.1 General**

1.1.1 Nil.

# **Intentionally Blank**

## **ENR 3.5 OTHER ROUTES**

### **1 INTRODUCTION**

#### **1.1 General**

1.1.1 Nil.

# **Intentionally Blank**



## **ENR 3.6 ENROUTE HOLDING**

### **1 INTRODUCTION**

#### **1.1 General**

1.1.1 Nil.

# **Intentionally Blank**

# **ENR 4 RADIO NAVIGATION AIDS/SYSTEMS**



## ENR 4.1 RADIO NAVIGATION AIDS — ENROUTE

### 1 RADIO NAVIGATION AIDS

#### 1.1 General

1.1.1 Table ENR 4.1 - 1 lists the radio navigation aids to be used in enroute navigation.

**Table ENR 4.1 - 1  
Radio Navigation Aids — Enroute**

STATION NAME	AID	IDENT	FREQ/ CHANNEL	HOURS	COORDINATES	DME ELEV	REMARKS
<b>AITUTAKI</b>	NDB	AI	320	H24	S18 49 29.28 W159 46 24.36		Rated coverage 100NM
<b>PENRHYN</b>	NDB	PY	400	O/R	S08 59 38.99 W158 02 37.83		Rated coverage 100NM
<b>RAROTONGA</b>	VOR	RG	113.5	H24	S21 12 05.93 W159 48 51.72		Unusable R105 to R160
	DME	RG	113.5 82X		S21 12 05.93 W159 48 51.72		NIL
	NDB	RG	352		S21 12 27.95 W159 49 16.72		Rated coverage 250NM

# **Intentionally Blank**

## **ENR 4.2 SPECIAL NAVIGATION SYSTEMS**

### **1 INTRODUCTION**

#### **1.1 General**

##### **1.1.1 Nil**

# **Intentionally Blank**



## **ENR 4.3 NAME–CODE DESIGNATORS FOR SIGNIFICANT POINTS**

### **1 INTRODUCTION**

#### **1.1 General**

1.1.1 Refer to CAA New Zealand Air Navigation Register [www.caa.govt.nz](http://www.caa.govt.nz)

# **Intentionally Blank**

## ENR 4.4 AERONAUTICAL GROUND LIGHTS — ENROUTE

### 1 INTRODUCTION

#### 1.1 General

1.1.1 Table ENR 4.4 - 1 lists all enroute aeronautical ground lights.

**Table ENR 4.4 - 1**  
**Aeronautical Ground Lights — Enroute**

AERONAUTICAL GROUND LIGHTS — ENROUTE	
NR	NIL at present
NAME	
TYPE	
CHARACTERISTICS/CODE	
HR	
COORDINATES	

# **Intentionally Blank**

# ENR 5 NAVIGATION WARNINGS



## **ENR 5.1 PROHIBITED, RESTRICTED AND DANGER AREAS**

### **1 DEFINITIONS**

#### **1.1 General**

1.1.1 All airspace in which a potential hazard to operations may exist and all areas over which the operation of civil aircraft may, for one reason or another be restricted either temporarily or permanently, are classified according to the following three types of area as defined by ICAO.

#### **1.2 Prohibited Area**

1.2.1 An airspace of defined dimensions, above the land area or territorial waters of a state, within which the flight of aircraft is prohibited. This term is used only when the flight of civil aircraft within the designated airspace is not permitted at any time under any circumstances.

#### **1.3 Restricted Area**

1.3.1 An airspace of defined dimensions, above the land area or territorial waters of a state, within which the flight of aircraft is restricted in accordance with certain specified conditions. This term is used whenever the flight of civil aircraft within the designated airspace is not absolutely prohibited but may be made only if specified conditions are complied with. Thus, prohibition of flight except at certain specified times leads to the designation of the airspace as a "restricted area" as would prohibition except in certain meteorological conditions. Similarly, prohibition of flight unless special permission had been obtained, leads to the designation of a restricted area.

1.3.2 However, conditions of flight imposed as a result of application of rules of the air and air traffic service practices or procedures (e.g. compliance with minimum safe heights or with rules stemming from the establishment of controlled airspace) do not constitute conditions calling for designation as a restricted area.

#### **1.4 Danger Area**

1.4.1 An airspace of defined dimensions within which activities dangerous to the flight of aircraft may exist at specified times. This term is used only when the potential danger to aircraft has not led to the designation of the airspace as restricted or prohibited.

1.4.2 The effect of the creation of the danger area is to caution operators or pilots of aircraft that it is necessary for them to assess the dangers in relation to their responsibility for the safety of their aircraft.

#### **1.5 Zone Identification**

1.5.1 Each area is numbered and a single series of numbers is used for all areas, regardless of type, to ensure that a number is never duplicated. Each area is as small as practicable, and contained within simple geometrical limits such as circle, square, etc.

1.5.2 The type of area involved is indicated by the letter

- (a) "P" — for Prohibited
- (b) "R" — for Restricted
- (c) "D" — for Danger

1.5.3 preceded by the Nationality designator.

1.5.4 These areas are also shown on charts using the chart symbols.

#### **1.6 Designated Prohibited, Restricted and Danger Areas**

1.6.1 There are no permanent designated Prohibited, Restricted or Danger areas in the Cook Sector of the Auckland Oceanic FIR. Prohibited, Restricted and Danger areas will be designated by NOTAM if required.



## **ENR 5.2 MILITARY EXERCISE AND TRAINING AREAS**

### **1 INTRODUCTION**

#### **1.1 General**

##### **1.1.1 Nil**

# **Intentionally Blank**

## ENR 5.3 OTHER ACTIVITIES OF A DANGEROUS NATURE

### 1 LOW FLYING ZONES

**Table ENR 5.3-1  
Low Flying Zones**

NAME	LATERAL LIMITS	UPPER LIMIT LOWER LIMIT	HOURS OF OPERATION	USING AGENCY
Titikaveka	All that airspace bounded by a line joining S 21 16 06.0, W 159 44 30.0; S 21 16 36.0, W 159 44 30.0; S 21 16 36.0, W 159 46 18.0; S 21 16 06.0, W 159 48 00.0; S 21 15 30.0; W 159 48 00.0; S 21 16 06.0, W 159 45 36.0; S 21 16 06.0, W 159 44 30.0	500ft AGL Surface	Daylight Hours	Air Rarotonga Ltd; PO Box 79, Rarotonga, Cook Islands Tel +682 22888

# **Intentionally Blank**

## **ENR 5.4 AIR NAVIGATION OBSTACLES — ENROUTE**

### **1 INTRODUCTION**

#### **1.1 General**

##### **1.1.1 Nil**

# **Intentionally Blank**

## **ENR 5.5 AERIAL SPORTING AND RECREATIONAL ACTIVITIES**

### **1 INTRODUCTION**

#### **1.1 General**

1.1.1 Microlight aircraft and parasail operations are possible in the vicinity of Rarotonga International Airport.

# **Intentionally Blank**



## **ENR 5.6 BIRD MIGRATION AND AREAS WITH SENSITIVE FAUNA**

### **1 INTRODUCTION**

#### **1.1 General**

##### **1.1.1 Nil**

# **Intentionally Blank**

# ENR 6 ENROUTE CHARTS



## **ENR 6.1 ENROUTE CHARTS**

### **1 INTRODUCTION**

#### **1.1 General**

1.1.1 Refer to Enroute Chart — Auckland Oceanic FIR.

- (a) Cook Islands Domestic Enroute Chart South
- (b) Cook Islands Domestic Enroute Chart North

# **Intentionally Blank**

# COOK ISLANDS DOMESTIC ENROUTE CHART

◀ SOUTH      NORTH ▶

## LEGEND

### Airspace

Control zone boundary (CTR) .....  
 Control area boundary (CTA) .....  
 FIR Boundary .....

### Facility data

Name: RAROTONGA  
 VOR/DME 113.5  
 NDB 352  
 Identification: RG  
 Latitude: S21 12 06  
 Longitude: W159 48 52

VOR and/or DME Frequency  
 NDB Frequency  
 Morse code ident

### Aerodromes

Civil

### Radio navigation facilities

NDB DME

### Enroute

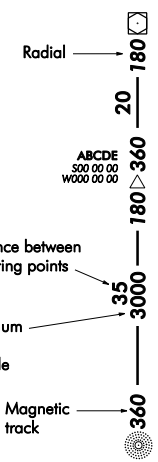
Track  
 Reporting points: Compulsory Non-compulsory   
 Enroute point

### Notes

- Bearings are magnetic
- Altitudes and elevations are in feet AMSL
- Routes are composite great circles with rhumb line tracks between reporting points

### CAUTION

At the time of preparation all information was extracted from the most reliable and up to date sources. There is, however, no assurance that aeronautical information and depiction is exact.



### COMMUNICATIONS FREQUENCIES

#### RAROTONGA

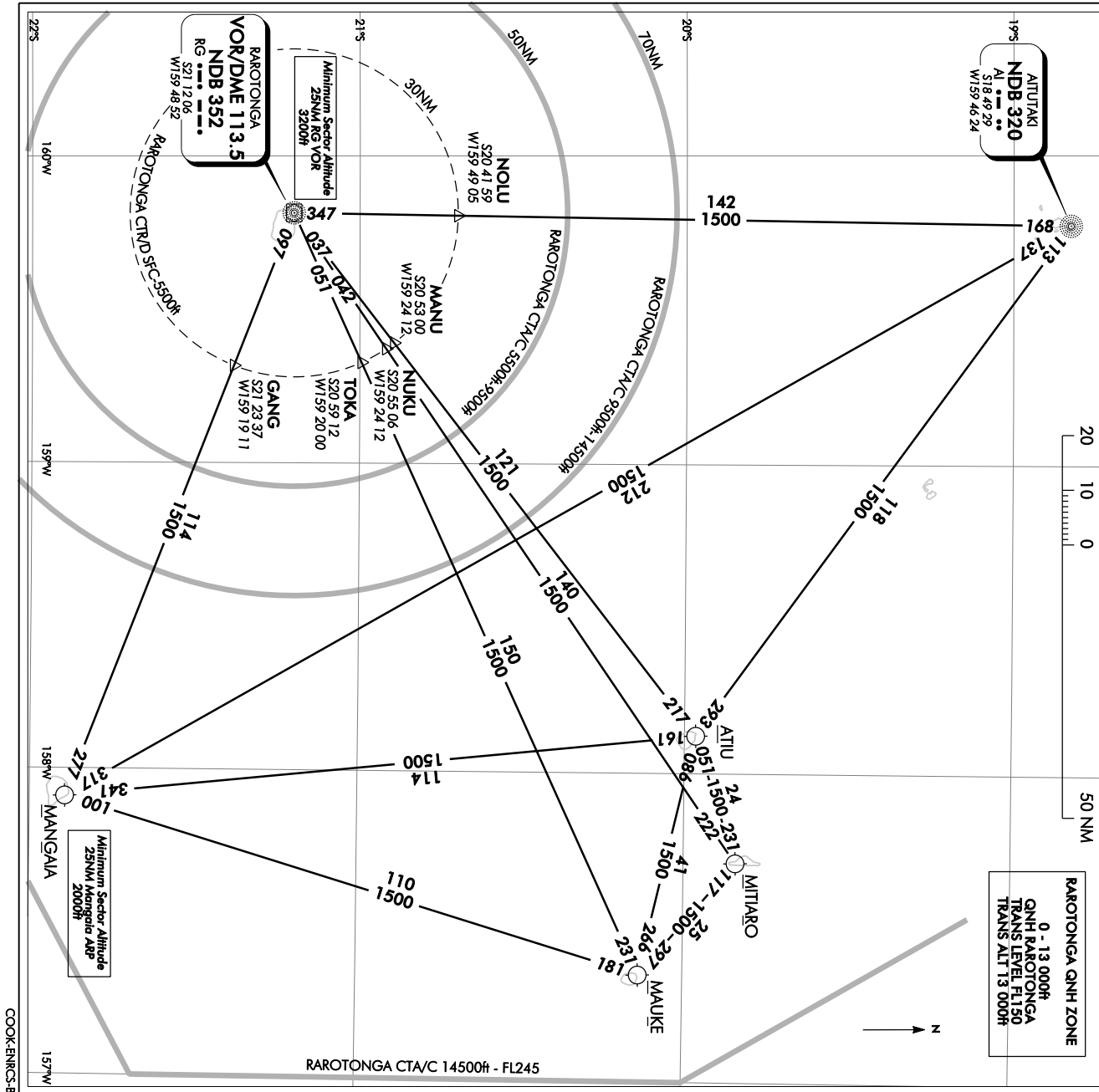
A/G	RAROTONGA	11339	8846	6553	3425
FIS	FLIGHT SERVICE	118.1	121.9		
APP	TOWER	118.1	121.9		
TWR	TOWER	118.1	121.9		
AFIS	FLIGHT SERVICE	118.1	121.9		

#### PENRHYN

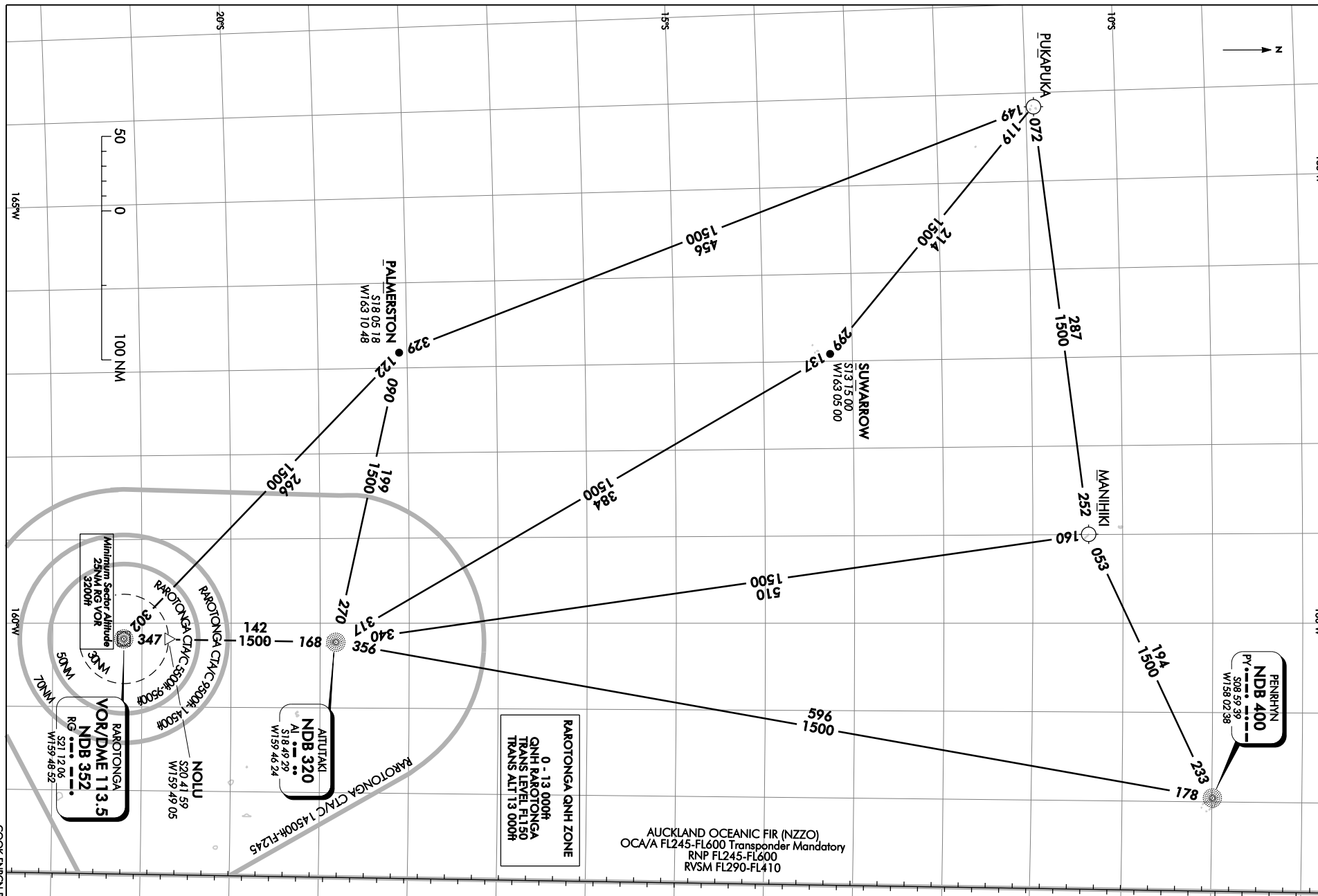
A/G	RADIO	118.1
-----	-------	-------

#### AITUTAKI, ATIU, MANGAIA, MAUKE, MITIARO, MANIHIKI, PUKAPUKA

UNATTENDED	TRAFFIC	118.1
------------	---------	-------



**Effective: 15 DEC 11**





**AD 0.6 TABLE OF CONTENTS — AD**

	<b><u>Page No.</u></b>
<b>AD 0.6 TABLE OF CONTENTS — AD .....</b>	<b>AD 0.6 - 1</b>
<b>AD 1 AERODROMES/HELIPORTS — INTRODUCTION .....</b>	<b>AD 1 - 1</b>
<b>AD 1.1 AERODROME/HELIPORT AVAILABILITY .....</b>	<b>AD 1.1 - 1</b>
1 Overall Aerodrome Authority .....	AD 1.1 - 1
1.1 General .....	AD 1.1 - 1
2 General Conditions Under Which Aerodromes are Available .....	AD 1.1 - 1
2.1 Airports of Entry .....	AD 1.1 - 1
2.2 Use of Aerodromes by Private Pilots .....	AD 1.1 - 2
<b>AD 1.2 RESCUE AND FIRE FIGHTING SERVICES .....</b>	<b>AD 1.2 - 1</b>
1 Rescue and Fire fighting services .....	AD 1.2 - 1
1.1 General .....	AD 1.2 - 1
<b>AD 1.3 INDEX TO AERODROMES AND HELIPORTS .....</b>	<b>AD 1.3 - 1</b>
1 Index of Aerodromes and Heliports .....	AD 1.3 - 1
1.1 Aerodromes .....	AD 1.3 - 1
<i>Table AD 1.3-1</i>	
<i>Index to Aerodromes .....</i>	<i>AD 1.3 - 1</i>
<b>AD 1.4 GROUPING OF AERODROMES/HELIPORTS .....</b>	<b>AD 1.4 - 1</b>
1 Public and Civil Aerodromes .....	AD 1.4 - 1
1.1 General .....	AD 1.4 - 1
1.2 International Aerodromes .....	AD 1.4 - 1
1.3 National Aerodromes .....	AD 1.4 - 1
1.4 Heliports .....	AD 1.4 - 1
1.5 Criteria for Grouping Aerodromes/Heliports in the Cook Islands .....	AD 1.4 - 2
<b>AD 1.5 USE OF DESIGNATED RUNWAYS, STRIPS AND VECTORS .....</b>	<b>AD 1.5 - 1</b>
1 Use of Runways, Strips and Vectors .....	AD 1.5 - 1
1.1 General .....	AD 1.5 - 1
1.2 Runway Vector Selection .....	AD 1.5 - 1

**Page No.**

<b>AD 1.6</b>	<b>AERODROME CONTROL CLEARANCES .....</b>	<b>AD 1.6 - 1</b>
1	Introduction .....	AD 1.6 - 1
1.1	General .....	AD 1.6 - 1
	<i>Figure AD 1.6-1</i>	
	<i>Positions for Clearance at Controlled Aerodromes .....</i>	<i>AD 1.6 - 1</i>
2	Landing Clearances .....	AD 1.6 - 2
2.1	General .....	AD 1.6 - 2
<b>AD 1.7</b>	<b>AERODROME CONTROL — RUNWAY SEPARATION .....</b>	<b>AD 1.7 - 1</b>
1	Introduction .....	AD 1.7 - 1
1.1	General .....	AD 1.7 - 1
2	Single Runway .....	AD 1.7 - 1
2.1	General .....	AD 1.7 - 1
3	Wake Turbulence .....	AD 1.7 - 2
3.1	General .....	AD 1.7 - 2
3.2	Weight Categories .....	AD 1.7 - 2
3.3	Wake Turbulence Separation .....	AD 1.7 - 3
	<i>Table AD 1.7-1</i>	
	<i>Wake Turbulence Separation Minima — Arriving Flights .....</i>	<i>AD 1.7 - 3</i>
	<i>Table AD 1.7-2</i>	
	<i>Wake Turbulence Separation Minima — Departing Flights .....</i>	<i>AD 1.7 - 3</i>
	<i>Table AD 1.7-3</i>	
	<i>Wake Turbulence Separation Minima — Arriving and Departing Flights .....</i>	<i>AD 1.7 - 4</i>
<b>AD 1.8</b>	<b>DEPARTURE FROM THE CIRCUIT .....</b>	<b>AD 1.8 - 1</b>
1	Introduction .....	AD 1.8 - 1
1.1	General .....	AD 1.8 - 1
<b>AD 1.9</b>	<b>AERODROME CIRCUIT PROCEDURES .....</b>	<b>AD 1.9 - 1</b>
1	Circuit Height .....	AD 1.9 - 1
1.1	General .....	AD 1.9 - 1
2	Standard Circuit Joining Procedure .....	AD 1.9 - 1
2.1	General .....	AD 1.9 - 1
	<i>Figure AD 1.9-1</i>	
	<i>Standard Overhead Joining Procedure .....</i>	<i>AD 1.9 - 2</i>
3	Circuit Joining Procedure — Controlled Aerodromes ..	AD 1.9 - 3
3.1	General .....	AD 1.9 - 3
4	Circuit Joining Procedures — Uncontrolled Aerodromes .....	AD 1.9 - 3
4.1	General .....	AD 1.9 - 3

**Page No.****AERODROMES**

<b>NCAI</b>	<b>AITUTAKI</b> .....	<b>NCAI AD 2 - 1</b>
<b>NCAT</b>	<b>ATIU</b> .....	<b>NCAT AD 2 - 1</b>
<b>NCMG</b>	<b>MANGAIA</b> .....	<b>NCMG AD 2 - 1</b>
<b>NCMH</b>	<b>MANIHIKI</b> .....	<b>NCMH AD 2 - 1</b>
<b>NCMK</b>	<b>MAUKE</b> .....	<b>NCMK AD 2 - 1</b>
<b>NCMR</b>	<b>MITIARO</b> .....	<b>NCMR AD 2 - 1</b>
<b>NCPY</b>	<b>PENRHYN</b> .....	<b>NCPY AD 2 - 1</b>
<b>NCPK</b>	<b>PUKAPUKA</b> .....	<b>NCPK AD 2 - 1</b>
<b>NCRG</b>	<b>RAROTONGA</b> .....	<b>NCRG AD 2 - 1</b>

# **Intentionally Blank**

# **AD 1 AERODROMES/HELIPORTS — INTRODUCTION**

# **Intentionally Blank**

## AD 1.1 AERODROME/HELIPORT AVAILABILITY

### 1 OVERALL AERODROME AUTHORITY

#### 1.1 General

1.1.1 The administration of aerodromes “open to public air traffic” is the responsibility of The Airport Authority, Cook Islands.

#### **Note**

Refer to [GEN 1.1](#) for postal and telegraphic addresses.

1.1.2 An aerodrome shall be said to be “open to public air traffic” when it is open for use by all aircraft having suitable technical characteristics, subject to the provisions in [section 2](#).

### 2 GENERAL CONDITIONS UNDER WHICH AERODROMES ARE AVAILABLE

#### 2.1 Airports of Entry

2.1.1 Aircraft flying into or departing from Cook Islands territory shall make their first landing at, or final departure from Rarotonga International airport.

**2.2 Use of Aerodromes by Private Pilots**

2.2.1 The following aerodromes are available for use for private operations:

Aitutaki  
Atiu  
Mangaia  
Manihiki  
Mauke  
Mitiaro  
Penrhyn  
Pukapuka  
Rarotonga INTL



---

## **AD 1.2 RESCUE AND FIRE FIGHTING SERVICES**

### **1 RESCUE AND FIRE FIGHTING SERVICES**

#### **1.1 General**

1.1.1 Rescue and fire fighting services are provided at Rarotonga International Airport.

# **Intentionally Blank**

## AD 1.3 INDEX TO AERODROMES AND HELIPORTS

### 1 INDEX OF AERODROMES AND HELIPORTS

#### 1.1 Aerodromes

1.1.1 Table AD 1.3 - 1 lists the available aerodromes/heliports for use.

**Table AD 1.3 -1  
Index to Aerodromes**

Aerodrome name, location, location indicator	Type of Traffic Permitted to use the aerodrome/heliport			Reference to AD Section and Remarks
	International/ National (INTL/NTL)	IFR/VFR	S = Scheduled NS = Non scheduled P = Private	
<b>AERODROMES</b>				
Aitutaki	NTL	IFR/VFR	S/NS/P	Nil
Atiu	NTL	IFR/VFR	S/NS/P	Nil
Mangaia	NTL	IFR/VFR	S/NS/P	Nil
Manihiki	NTL	IFR/VFR	S/NS/P	Nil
Mauke	NTL	IFR/VFR	S/NS/P	Nil
Mitiaro	NTL	IFR/VFR	S/NS/P	Nil
Penrhyn	NTL	IFR/VFR	NS/P	Nil
Pukapuka	NTL	IFR/VFR	NS/P	Nil
Rarotonga INTL	INTL/NTL	IFR/VFR	S/NS/P	Nil
<b>HELIPORTS</b>				
Nil	Nil	Nil	Nil	Nil

# **Intentionally Blank**

## **AD 1.4 GROUPING OF AERODROMES/HELIPORTS**

### **1 PUBLIC AND CIVIL AERODROMES**

#### **1.1 General**

1.1.1 All aerodromes in [Table AD 1.3 - 1](#) are Public/Civil aerodromes.

#### **1.2 International Aerodromes**

1.2.1 There is one international aerodrome in the Cook Islands. It is:

(a) Rarotonga INTL.

#### **1.3 National Aerodromes**

1.3.1 There are eight national aerodromes in the Cook Islands. They are:

(a) Aitutaki

(b) Atiu

(c) Mangaia

(d) Manihiki

(e) Mauke

(f) Mitiaro

(g) Penrhyn

(h) Pukapuka

#### **1.4 Heliports**

1.4.1 There are no heliports in the Cook Islands.

**1.5 Criteria for Grouping Aerodromes/Heliports in the Cook Islands**

1.5.1 The criteria applied by the Cook Islands in grouping aerodromes/heliports for the provision of information in this AIP are as follows:

***Primary/major international aerodrome/heliport***

1.5.2 The aerodrome/heliport of entry and departure for international air traffic, where all formalities concerning Customs, immigration, health, animal and plant quarantine and similar procedures are carried out and where air traffic services are available on a regular basis.

***Secondary/other international aerodrome/heliport***

1.5.3 Another aerodrome/heliport available for the entry or departure of international air traffic, where the formalities concerning Customs, immigration, health and similar procedures and air traffic services are made available, on a restricted basis, to flights with prior approval only.

***National aerodrome/heliport***

1.5.4 An aerodrome/heliport available only for domestic air traffic, including those military aerodromes/heliports where civil air traffic is allowed under certain conditions.

## **AD 1.5 USE OF DESIGNATED RUNWAYS, STRIPS AND VECTORS**

### **1 USE OF RUNWAYS, STRIPS AND VECTORS**

#### **1.1 General**

1.1.1 At aerodromes where runways, strips and/or vectors are defined and promulgated in the aerodrome charts. Aircraft take-offs and landings are restricted to those defined runways, strips or vectors. The aerodrome charts depict the location of the runways, strips and vectors.

#### **1.2 Runway Vector Selection**

1.2.1 Where aerodrome control is being provided, the designated runway is that best favouring the wind direction and the take-off length requirements of the majority of the traffic. All aircraft are informed of the runway-in-use by the ATS unit.

# **Intentionally Blank**



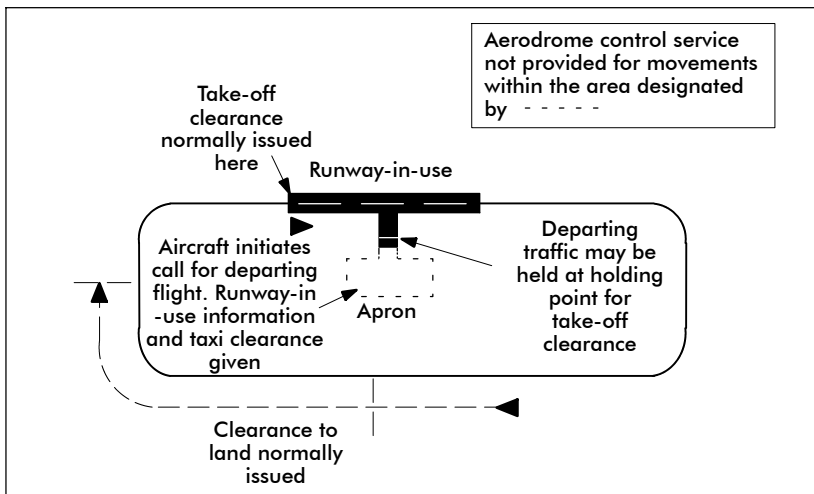
## AD 1.6 AERODROME CONTROL CLEARANCES

### 1 INTRODUCTION

#### 1.1 General

1.1.1 Figure AD 1.6 - 1 shows the positions where aircraft at controlled aerodromes normally receive aerodrome control clearances, either by radio or light signals.

**Figure AD 1.6 - 1**  
**Positions for Clearance at Controlled Aerodromes**



## 2 LANDING CLEARANCES

### 2.1 General

2.1.1 A landing aircraft is not permitted to cross the threshold of the runway on its final approach until:

- (a) a preceding departing aircraft has crossed the end of the runway-in-use or has started a turn; or
- (b) all preceding landing aircraft are clear of the runway-in-use.

#### **Notes**

It is the responsibility of pilots operating into AFIS or unattended aerodromes to arrange the flight paths of their aircraft to conform to these standards.

At controlled aerodromes the aerodrome controller may issue a qualified landing clearance by day only, to an aircraft on final approach when it is obvious that a preceding landing or departing aircraft will be clear of the runway before the approaching aircraft crosses the threshold.

Examples of qualified landing clearances are as follow :

- (a) "737 VACATING RUNWAY RIGHT, XYZ CLEARED TO LAND"
- (b) "ISLANDER DEPARTING, XYZ CLEARED TO LAND"

It is the responsibility of the pilot of a landing aircraft to "go around" if he or she considers that the runway separation criteria detailed above cannot be met. Pilots are reminded of the possibility of wake turbulence when following another landing or a departing aircraft and of the fact that it may persist to a varying degree depending on the direction and strength of the surface wind.

## **AD 1.7 AERODROME CONTROL — RUNWAY SEPARATION**

### **1 INTRODUCTION**

#### **1.1 General**

1.1.1 The runway separation standards applied by ATC between aircraft taking off, between aircraft landing and between aircraft landing and taking off is outlined below. These standards may be increased if IFR flights are involved. When wake turbulence in the landing or take-off path could be significant, runway separation will be increased by ATC as indicated in 3.

1.1.2 The runway separation minima outlined below will be applied to aircraft landing or taking off, except that these separation minima will not apply to aircraft in formation in respect of other aircraft in the same formation.

### **2 SINGLE RUNWAY**

#### **2.1 General**

2.1.1 An aircraft will not be cleared for take-off until:

- (a) a preceding aircraft has crossed the up-wind end of the runway-in-use or has started a turn, except that if both aircraft are below 2,300kg MCTOW and the following aircraft is not significantly faster than the leading aircraft, separation may be reduced to 610m provided the leading aircraft is airborne; or
- (b) all preceding landing aircraft are clear of the runway-in-use.

2.1.2 A landing aircraft is not permitted to cross the threshold of the runway on final approach until:

- (a) a preceding departing aircraft has crossed the up-wind end of the runway-in-use or has started a turn; or
- (b) all preceding landing aircraft are clear of the runway-in-use.

### **3 WAKE TURBULENCE**

#### **3.1 General**

3.1.1 Wake turbulence separation is provided by ATC to all aircraft which may be affected by wake turbulence, except in the case of IFR aircraft making a visual approach or VFR arrivals. In these cases it is the pilot's responsibility to provide adequate spacing from the proceeding arriving or departing aircraft, and in these circumstances, ATC will make allowance for such pilot initiated manoeuvres when sequencing additional following aircraft. The required spacings are shown in [Section 3.3](#).

3.1.2 Whenever practicable, ATC will advise aircraft of the expected occurrence of hazards caused by wake turbulence by issuing a caution to the pilot, "CAUTION — WAKE TURBULENCE". It should be noted, however, that the occurrence of wake turbulence hazards cannot be accurately predicted, and ATC cannot assume responsibility for issuing such advice at all times, nor its accuracy.

#### **3.2 Weight Categories**

3.2.1 For the purposes of assessing wake turbulence separation, aircraft are divided into the following weight categories:

##### ***Heavy (H)***

3.2.2 All types of aircraft of 136,000kg maximum weight or more. Includes A330, A340, C141, B747 series, B767, MD11 and DC10.

##### ***Medium (M)***

3.2.3 All types of aircraft of less than 136,000kg maximum weight but more than 7,000kg. Includes A320, B727, B737 series, F27, BA46, C130, P3, SF34 and SW4.

##### ***Light (L)***

3.2.4 All types of aircraft of 7,000kg maximum weight or less. Includes BN2P, C402, C421, NOMA, PA31, E110 and SW3.

3.2.5 For further information on wake turbulence categories refer to ICAO Doc 8643 — *Aircraft Type Designators*.

### 3.3 Wake Turbulence Separation

3.3.1 The following minimum time separations apply between aircraft using the same runway or grass strip, or where there is a possibility that the projected flight profiles will cross at the same altitude or less than 1,000ft below.

#### *Between Arriving Flights*

**Table AD 1.7 - 1  
Wake Turbulence Separation Minima — Arriving Flights**

LEADING AIRCRAFT	FOLLOWING AIRCRAFT	MINIMUM TIME
Heavy	Medium, Light	2 minutes, 3 minutes
Medium	Light	3 minutes

#### *Between Departing Flights*

**Table AD 1.7 - 2  
Wake Turbulence Separation Minima — Departing Flights**

LEADING AIRCRAFT	FOLLOWING AIRCRAFT	DEPARTURE FROM SAME TAKE-OFF POSITION	DEPARTURE FROM INTERMEDIATE TAKE-OFF POSITION
Heavy	Medium, Light	2 minutes	3 minutes
Medium	Light		

***Between Arriving and Departing Flights***

3.3.2 The minimum time separations shown in [Table AD 1.7 - 1](#) and [Table AD 1.7 - 2](#) apply between arriving and departing aircraft if the flight path of the following aircraft will cross the projected flight path of the leading aircraft e.g. when an arriving aircraft is operating onto a runway with a displaced landing threshold.

**Table AD 1.7 - 3**  
**Wake Turbulence Separation Minima — Arriving and Departing Flights**

LEADING AIRCRAFT	FOLLOWING AIRCRAFT	MINIMUM SPACING AT TIME AIRCRAFT ARE AIRBORNE OR HAVE TOUCHED DOWN
Heavy arrival	Medium departure, Light departure	2 minutes
Medium arrival	Light departure	
Heavy departure	Medium arrival, Light arrival	
Medium departure	Light arrival	

***Opposite Direction Runway Operations***

3.3.3 A minimum of 2 minutes' separation will be provided between a Heavy aircraft take-off and the departure of a Medium or Light aircraft, or between a Medium aircraft take-off and the departure of a Light aircraft, from the opposite direction runway if the projected flight profiles will cross.

3.3.4 A minimum of 2 minutes' separation will be provided between a Heavy aircraft making a low or missed approach and the departure of a Medium or Light aircraft, or between a Medium aircraft making a low or missed approach and the departure of a Light aircraft from the opposite direction runway.

***Notes***

If a pilot considers the wake turbulence separation standards inadequate, an increased separation may be requested by specifying the spacing required.

If ATC considers the wake turbulence separation provided is inadequate or that it needs to be applied for any situation not covered by a specified minimum the pilot will be advised and an appropriate separation applied.

Notwithstanding the above separation standards, if pilots consider that the effect of wake turbulence can be nullified by ensuring that flight profiles do not cross, they may request and be granted exemption from these separations. ATC will advise the category or type of the other aircraft where that aircraft is a Heavy aircraft.

# **Intentionally Blank**



## **AD 1.8 DEPARTURE FROM THE CIRCUIT**

### **1 INTRODUCTION**

#### **1.1 General**

1.1.1 The pilot of a VFR aircraft departing the traffic circuit must make all turns in the direction of the traffic circuit, unless:

- (a) otherwise authorised by ATC; or
- (b) if at an uncontrolled aerodrome, the pilot is clear of the circuit area or 1,500ft above the aerodrome.

# **Intentionally Blank**

## AD 1.9 AERODROME CIRCUIT PROCEDURES

### 1 CIRCUIT HEIGHT

#### 1.1 General

1.1.1 Unless otherwise specified on the aerodrome chart the circuit height will be 1,000ft above the aerodrome elevation.

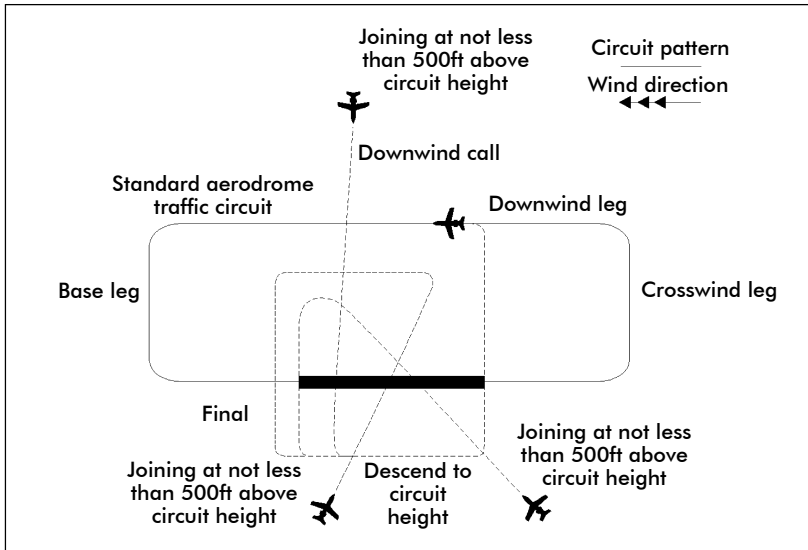
### 2 STANDARD CIRCUIT JOINING PROCEDURE

#### 2.1 General

2.1.1 The standard joining procedure is shown in [Figure AD 1.9 - 1](#). This procedure should be followed when a pilot is unfamiliar with the aerodrome or is uncertain of other circuit traffic:

- (a) Unless otherwise specified on the appropriate aerodrome chart, approach the aerodrome by descending or climbing to not less than 1,500ft above aerodrome elevation or not less than 500ft above circuit height if a circuit height other than 1,000ft is specified on the landing chart, and observe the wind, circuit direction and any ground signals displayed. If the ceiling will not permit flight above 1,000ft or other specified circuit height, an aircraft may enter at a lower altitude but must avoid passing through the circuit pattern.
- (b) Make all subsequent turns in the direction of the traffic circuit.

**Figure AD 1.9 - 1**  
**Standard Overhead Joining Procedure**



- (c) Join the non-traffic side of the circuit and descend to circuit height, first observing the position of other aircraft taking off or landing or flying in the circuit in order to ensure adequate spacing when joining on the downwind leg.

**Note**

If aircraft already in the circuit appear likely to prevent adequate spacing being achieved, maintain altitude and re-circuit the aerodrome.

- (a) Turn ninety degrees across wind and pass sufficiently close to the upwind boundary of the aerodrome to ensure that aircraft taking off can pass safely underneath.
- (b) Turn to join the downwind leg of the traffic circuit at a point which ensures adequate spacing with any aircraft in the circuit ahead or behind.

### **3 CIRCUIT JOINING PROCEDURE — CONTROLLED AERODROMES**

#### **3.1 General**

3.1.1 Aircraft intending to land at a controlled aerodrome must join the circuit in accordance with ATC instructions. The following joining procedures may be specified:

- (a) by descending to circuit height prior to joining and making either a straight-in approach to the runway-in-use or joining a downwind leg or base leg; or
- (b) as outlined in the standard circuit joining procedure above.

### **4 CIRCUIT JOINING PROCEDURES — UNCONTROLLED AERODROMES**

#### **4.1 General**

4.1.1 The pilot of an aircraft intending to land at an unattended aerodrome may join the circuit in the way outlined in the circuit joining procedure for controlled aerodromes provided that:

- (a) the runway-in-use and aerodrome traffic are properly ascertained; and
- (b) when making a straight-in approach, or joining a downwind or base leg, the aircraft is sequenced in such a way as to give priority to other aircraft already established in the circuit or joining in accordance with the standard circuit joining procedure described above; and
- (c) when entering or flying within the circuit, all turns are made in the direction appropriate to the runway-in-use.

# **Intentionally Blank**

## NCAI AD 2.1 AERODROME LOCATION INDICATOR AND NAME

NCAI	AITUTAKI
------	----------

## NCAI AD 2.2 AERODROME GEOGRAPHICAL AND ADMINISTRATIVE DATA

<b>1</b>	ARP co-ordinates and site at AD	S 18 49 51.97 W 159 45 50.49 ARP site as depicted on NCAI AD 2-51.1
<b>2</b>	Direction and distance from city	5km NE of town (North end of Aitutaki Island)
<b>3</b>	Elevation/Reference temperature	20ft
<b>4</b>	MAG VAR/Annual change	13°E (2016)
<b>5</b>	AD Administration, address, telephone, telefax, telex, AFS	Licensee: Cook Islands Airport Authority PO Box 90 Rarotonga Tel (682) 21890 NCRGYDYX
<b>6</b>	Types of traffic permitted (IFR/VFR)	IFR/VFR
<b>7</b>	Remarks	Nil

### NCAI AD 2.3 OPERATIONAL HOURS

<b>1</b>	AD Administration	0800–1600 Mon–Fri except public holidays
<b>2</b>	Customs and immigration	Nil
<b>3</b>	Health and sanitation	H24
<b>4</b>	AIS Briefing Office	Nil
<b>5</b>	ATS Reporting Office (ARO)	Nil
<b>6</b>	MET Briefing Office	Rarotonga Meteorological Office H24
<b>7</b>	ATS	Nil
<b>8</b>	Fuelling	By prior arrangement through Pacific Petroleum (Rarotonga) or Air Rarotonga
<b>9</b>	Handling	Air Rarotonga
<b>10</b>	Security	Nil
<b>11</b>	De-icing	Nil
<b>12</b>	Remarks	Terminal services available during domestic flights

### NCAI AD 2.4 HANDLING SERVICES AND FACILITIES

<b>1</b>	Cargo-handling facilities	By arrangement with Air Rarotonga
<b>2</b>	Fuel/oil types	Nil
<b>3</b>	Fuelling facilities/capabilities	Nil
<b>4</b>	De-icing facilities	Nil
<b>5</b>	Hangar space for visiting aircraft	Nil
<b>6</b>	Repair facilities for visiting aircraft	Nil
<b>7</b>	Remarks	Nil



**NCAI AD 2.5 PASSENGER FACILITIES**

<b>1</b>	Hotels	Accommodation facilities near airport and around island
<b>2</b>	Restaurants	In town and around island
<b>3</b>	Transportation	Hotel transfers, rental cars
<b>4</b>	Medical facilities	Hospital
<b>5</b>	Bank and Post Office	In town
<b>6</b>	Tourist Office	In town
<b>7</b>	Remarks	Nil

**NCAI AD 2.6 RESCUE AND FIRE FIGHTING SERVICES**

<b>1</b>	AD Category for firefighting	Category 4
<b>2</b>	Rescue equipment	Portable lighting, bolt cutting equipment, breathing apparatus, medical equipment, communications equipment, portable radios, stretchers
<b>3</b>	Capability for removal of disabled aircraft	For aircraft up to 13000kg: equipment available locally
<b>4</b>	Remarks	Nil

**NCAI AD 2.7 SEASONAL AVAILABILITY — CLEARING**

<b>1</b>	Types of clearing equipment	Nil
<b>2</b>	Clearing priorities	Nil
<b>3</b>	Remarks	Nil

## NCAI AD 2.8 APRONS, TAXIWAYS AND CHECK LOCATIONS DATA

<b>1</b>	Apron surface and strength	Bitumen PCN 22/F/B/1.24/T
<b>2</b>	Taxiway width, surface and strength	Bitumen PCN 22/F/B/1.24/T
<b>3</b>	ACL location and elevation	RWY 14 20ft RWY 32 15ft
<b>4</b>	VOR/INS checkpoints	Nil
<b>5</b>	Remarks	Nil

## NCAI AD 2.9 SURFACE MOVEMENT GUIDANCE, CONTROL SYSTEM AND MARKINGS

<b>1</b>	Use of aircraft stand ID signs, TWY guidelines and visual docking/parking guidance system of aircraft stands	Nil
<b>2</b>	RWY and TWY markings and LGT	RWY designation, centreline unlit, RWY End and THR lit.
<b>3</b>	Stop Bars	Nil
<b>4</b>	Remarks	Nil

## NCAI AD 2.10 AERODROME OBSTACLES

In approach/TKOF areas			In circling area and at AD		Remarks
1			2		
RWY/Area affected	Obstacle type Elevation Markings/ LGT	Coordinates	Obstacle type Elevation Markings/ LGT	Coordinates	
a	b	c	a	b	

## NCAI AD 2.11 METEOROLOGICAL INFORMATION PROVIDED

<b>1</b>	Associated MET Office	Rarotonga Meteorological Office
<b>2</b>	Hours of service MET Office	Nil
<b>3</b>	Office responsible for TAF preparation Periods of validity	Nadi Meteorological Office
<b>4</b>	Type of landing forecast Interval of issuance	
<b>5</b>	Briefing/consultation provided	
<b>6</b>	Flight documentation	English
<b>7</b>	Charts and other information available for briefing or consultation	AWS, TAF, ARFOR SOUTHERN COOKS available from Rarotonga ATS
<b>8</b>	Supplementary equipment available for providing information	
<b>9</b>	ATS units provided with information	Rarotonga ATS
<b>10</b>	Additional information (limitation of service, etc.)	Met info derived from Rarotonga MET Service

## NCAI AD 2.12 RWY PHYSICAL CHARACTERISTICS

RWY	TRUE and MAG BRG	Dimensions of RWY (m)	Strength (PCN) and surface of RWY and SWY	THR coordinates	THR elevation and highest elevation of TDZ of precision APP RWY
1	2	3	4	5	6
14	154°T 141°M	1824 x 30	PCN 22 F/B/1.24/T Bitumen	S18 49 46.71 W159 45 53.18	20ft
32	334°T 321°M	1824 x 30	PCN 22 F/B/1.24/T Bitumen	S18 50 40.05 W159 45 25.92	15ft

Slope of RWY-SWY	SWY dimensions (m)	CWY Dimensions (m)	Strip dimensions (m)	OFZ	Remarks
7	8	9	10	11	12
0.07D		140	2100 x 150		RESA 90 x 60m
0.07U		140	2100 x 150		RESA 90 x 60m

## NCAI AD 2.13 DECLARED DISTANCES

RWY	TORA (m)	TODA (m)	ASDA (m)	LDA (m)	Remarks
1	2	3	4	5	6
14	1824	1964	1824	1824 <sup>1</sup>	
32	1824	1964	1824	1824 <sup>1</sup>	

<sup>1</sup> Landing distance available is based on a 1:50 gradient

**NCAI AD 2.14    APPROACH AND RWY LIGHTING**

<b>RWY</b>	<b>APCH LGT Type LEN INTST</b>	<b>THR LGT Colour WBAR</b>	<b>VASIS (MEH) PAPI</b>	<b>TDZ LGT LEN</b>	<b>RWY Centre Line LGT LEN Spacing Colour, INTST</b>	<b>RWY Edge LGT LEN Spacing Colour, INTST</b>	<b>RWY End LGT Colour WBAR</b>	<b>SWY LGT LEN (m) Colour</b>	<b>Remarks</b>
<b>14</b>	Nil	Nil	PAPI 3.00° TCH 50ft	Nil	Nil	LIH Omni white	LIH uni- directional red	Nil	Nil
<b>32</b>	Nil	Nil	PAPI 3.00° TCH 50ft	Nil	Nil	LIH Omni white	LIH uni- directional red	Nil	Nil

## NCAI AD 2.15 OTHER LIGHTING, SECONDARY POWER SUPPLY

<b>1</b>	ABN/IBN location, characteristics and hours of operation	Not available
<b>2</b>	LDI location and LGT, Anemometer location and LGT	Not available
<b>3</b>	TWY edge and centreline lighting	Not available
<b>4</b>	Secondary power supply/switch-over time	Standby power generator within 5 seconds
<b>5</b>	Remarks	Nil

## NCAI AD 2.16 HELICOPTER LANDING AREA

<b>1</b>	Co-ordinates of TLOF or THR of FATO	N/A
<b>2</b>	TLOF and/or FATO elevation (ft)	
<b>3</b>	TLOF and FATO area dimensions, surface, strength and markings	
<b>4</b>	True and MAG BRG of FATO	
<b>5</b>	Declared distance available	
<b>6</b>	APP and FATO lighting	
<b>7</b>	Remarks	

**NCAI AD 2.17    ATS AIRSPACE**

<b>1</b>	Designation and lateral limits	Nil
<b>2</b>	Vertical limits	Nil
<b>3</b>	Airspace classification	Nil
<b>4</b>	ATS unit callsign, language(s)	Nil
<b>5</b>	Transition altitude	13000ft
<b>6</b>	Remarks	Nil

**NCAI AD 2.18    ATS COMMUNICATIONS FACILITIES**

<b>Service Designation</b>	<b>Callsign</b>	<b>Frequency</b>	<b>Hours of Operation</b>	<b>Remarks</b>
<b>FIS</b>	Rarotonga	3425* 6553 8846 11339	HS *OR	
<b>APP</b>	Nil			
<b>TWR</b>	Nil			
<b>AFIS</b>	Nil			

**NCAI AD 2.19 RADIO NAVIGATION AND LANDING AIDS**

<b>Type of Aid, CAT (for ILS), Variation</b>	NDB
<b>Identification</b>	AI
<b>Frequency</b>	320
<b>Hours of Operation</b>	H24
<b>Co-ordinates</b>	S18 49 29.28 W159 46 24.36
<b>Elevation of DME antenna</b>	
<b>Remarks</b>	Rated coverage: 100NM



## **NCAI AD 2.20 LOCAL TRAFFIC REGULATIONS**

### **1 AERODROME REGULATIONS**

1.1 Pilots are to maintain a continuous listening watch on the frequency listed in the COM box on the Aitutaki aerodrome chart, or on 118.1 MHz.

1.2 For the benefit of other traffic, pilots should broadcast their position, altitude and intentions as listed below:

- (a) Inbound
    - (i) overhead the radio aid serving the aerodrome, or commencing instrument approach; and
    - (ii) when established on final approach; and
    - (iii) at the termination of the instrument approach, i.e. when breaking off from the procedure to proceed in VMC to the aerodrome; and
    - (iv) immediately before joining the traffic circuit.
  - (b) In circuit: downwind when abeam the upwind end of the RWY.
  - (c) Taking off:
    - (i) when about to taxi to the take-off position; and
    - (ii) immediately before take-off; if leaving the traffic circuit, the direction of flight should be indicated.
  - (d) In transit: between 5–10 NM from the aerodrome.
- 1.3 Each aircraft transmission is to be preceded by the name of the aerodrome, "AITUTAKI TRAFFIC".

### **2 TAXIING TO AND FROM STANDS**

2.1 There is one parking pad available for aircraft.

## **NCAI AD 2.21 NOISE ABATEMENT PROCEDURES**

There are no published noise abatement procedures for Aitutaki.

## **NCAI AD 2.22 FLIGHT PROCEDURES**

### **1 POSITION AND ALTITUDE REPORTING — LOCAL VFR FLIGHTS**

1.1 Pilots of aircraft intending to operate under VFR from Aitutaki are required to report departure details after take-off on the nominated HF frequencies to Rarotonga "TOWER/FLIGHT SERVICE" if intending to proceed to other aerodromes in the vicinity or when requesting clearance to enter Class C airspace.

1.2 When Rarotonga Flight Service is operating Rarotonga CTA Class C airspace reverts to Class G.

### **2 POSITION REPORTING ON DEPARTURE**

2.1 Pilots are required to make a departure report as soon as practicable after take-off on the nominated HF frequencies to Rarotonga "TOWER/FLIGHT SERVICE" and must contain the following information:

- (a) Identification; radio callsign
- (b) Estimated set heading time in minutes past the hour
- (c) Phrase "CLIMBING TO" or "REQUEST" followed by altitude or flight level;
- (d) Next position and time over: or ETA at destination in minutes past the hour

2.2 When Rarotonga Flight Service is operating Rarotonga CTA Class C airspace reverts to Class G.

### **3 AERODROME TRAFFIC CIRCUIT RULES**

3.1 Circuit direction is:

- (a) RWY 14 is left-hand
- (b) RWY 32 is right-hand

## **NCAI AD 2.23 ADDITIONAL INFORMATION**

Nil

**NCAI AD 2.24 CHARTS RELATED TO AERODROME**

## (a) Instrument Approach Charts

AITUTAKI NDB RWY 14 ..... NCAI AD 2-44.1

AITUTAKI RNAV (GNSS) RWY 14 ..... NCAI AD 2-45.1

AITUTAKI RNAV (GNSS) RWY 32 ..... NCAI AD 2-45.2

## (b) Aerodrome Charts

AITUTAKI ..... NCAI AD 2-51.1

# **Intentionally Blank**

ELEV 20

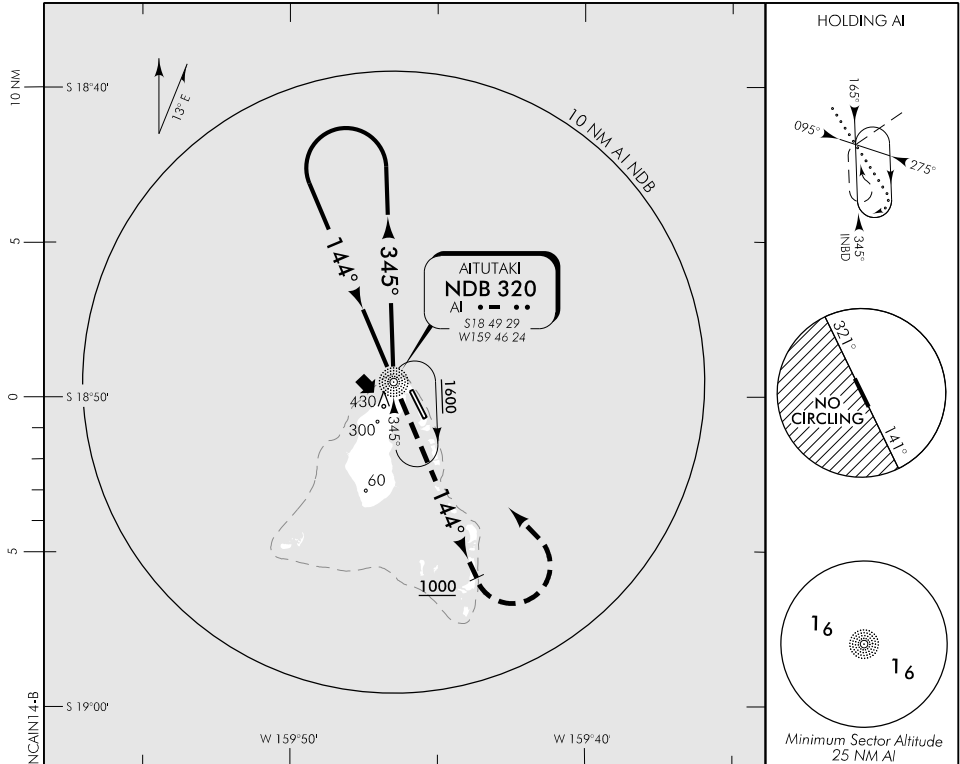
CAT A,B,C

**AITUTAKI**

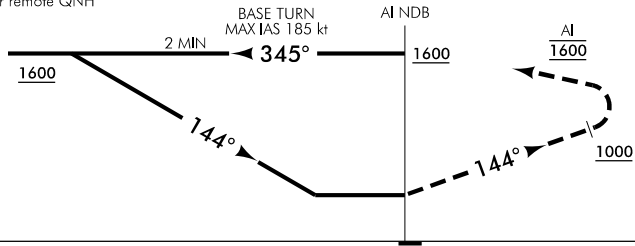
RWY 14 THR ELEV 20

**NDB RWY 14**

UNATTENDED: 118.1



Use Aitutaki QNH or remote QNH



**MISSED APCH:** Track 144° to 1000, turn LEFT direct to AI NDB 1600

Category	A	B	C	D
NDB	680(660) – 2500		680(660) – 3600	NA
Circling *	680(660) – 2500	680(660) – 2800	680(660) – 3700	

\* Circling NA west of RWY 14/32

**Effective: 25 MAY 17**

Changes from 15 DEC 11: Circling restriction, MNM SECT ALT, minima, profile, missed APCH, outbound BRG and MSA, hold, aerodrome elevations.

**Intentionally  
Blank**

ELEV 20

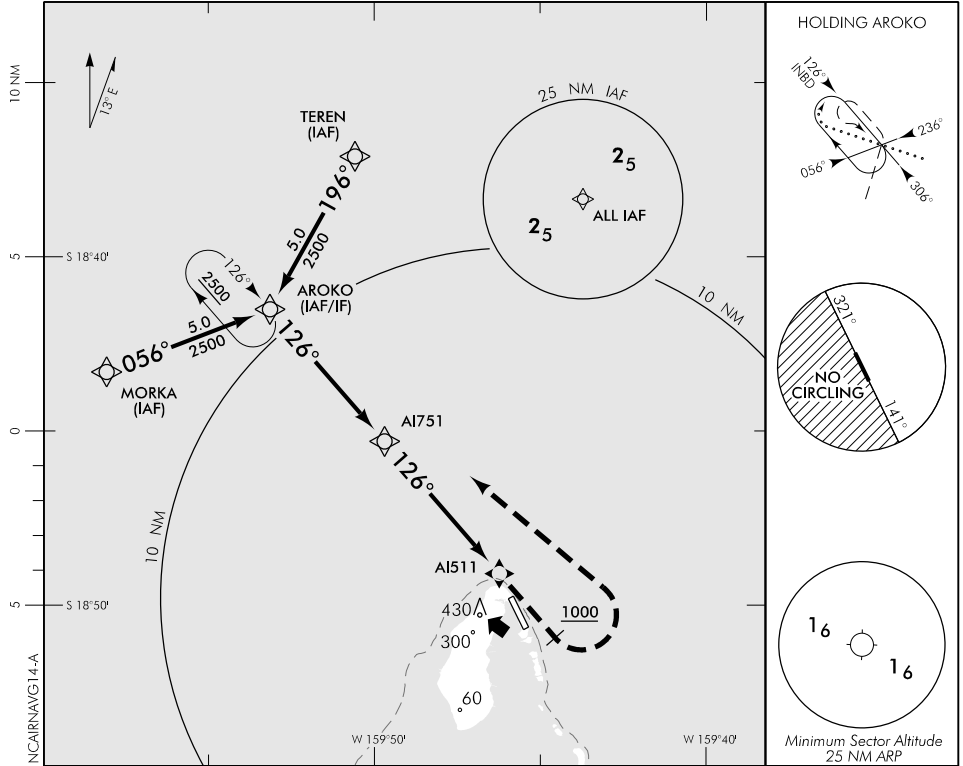
CAT A,B,C

**AITUTAKI**

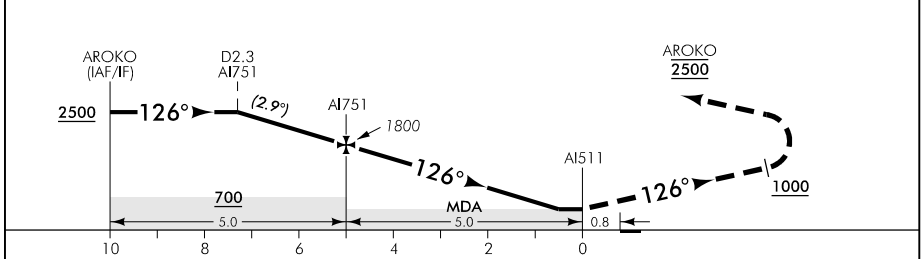
RWY 14 THR ELEV 20

**RNAV (GNSS) RWY 14**

UNATTENDED: 118.1



Use Aitutaki QNH or remote QNH



New chart.

**MISSED APCH:** Track 126° to 1000, turn LEFT direct to AROKO 2500

DISTANCE to WPT	AROKO	4	3	2	1	AI751	4	3	2	1	0.5	AI511
Advisory Altitude 5%	3300	3000	2700	2400	2100	1800	1500	1200	900	600	MDA	MDA
Category	A			B			C			D		
LNAV	440(420) – 1600						440(420) – 2400			NA		
Circling *	450(430) – 1900			520(500) – 2800			620(600) – 3700			NA		

\* Circling NA west of RWY 14/32

**Effective: 25 MAY 17**

ELEV 20

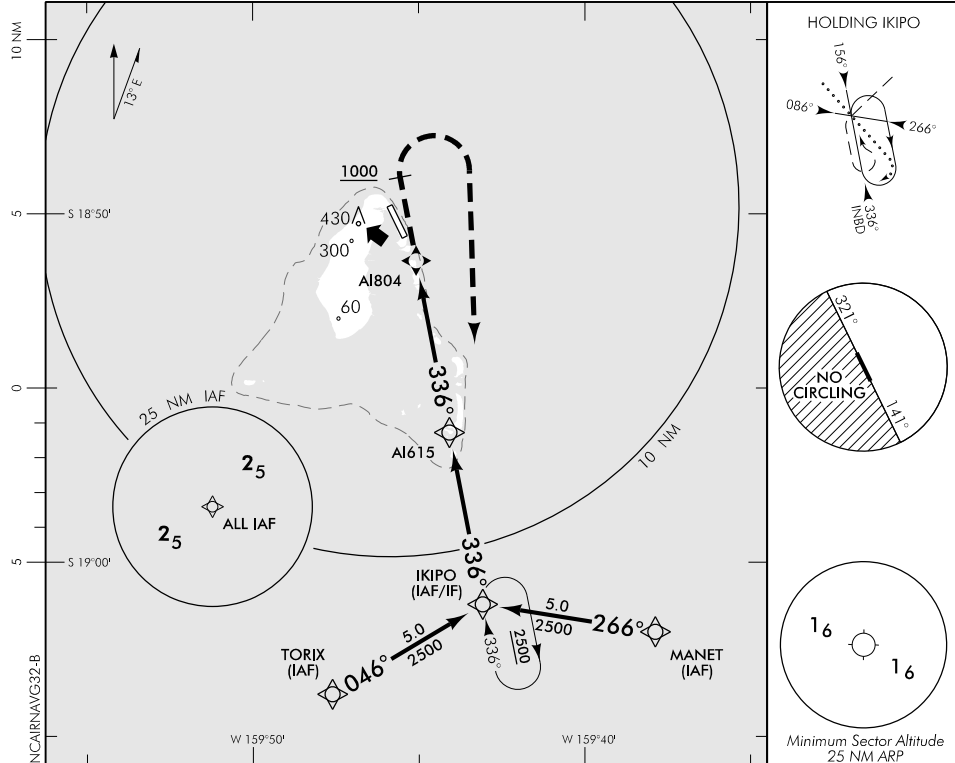
CAT A,B,C

# AITUTAKI

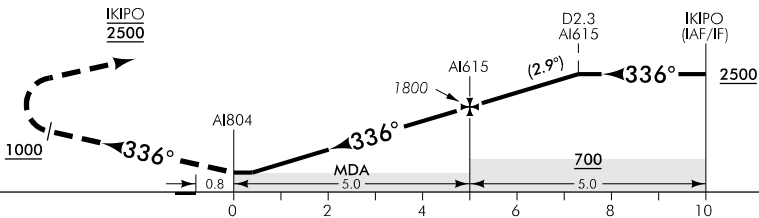
RWY 32 THR ELEV 15

## RNAV (GNSS) RWY 32

UNATTENDED: 118.1



Use Aitutaki QNH or remote QNH



**MISSED APCH:** Track 336° to 1000, turn RIGHT direct to IKIPO 2500

DISTANCE to WPT	AI804	0.4	1	2	3	4	AI615	1	2	3	4	IKIPO
Advisory Altitude 5%	MDA	MDA	600	900	1200	1500	1800	2100	2400	2700	3000	3300
Category	A			B			C			D		
LNAV	400(380) – 1600						430(410) – 2400			NA		
Circling *	450(430) – 1900			520(500) – 2800			620(600) – 3700			NA		
* Circling NA west of RWY 14/32												

Changes from 25 MAY 17: RWY 32 THR ELEV.

**Effective: 13 SEP 18**

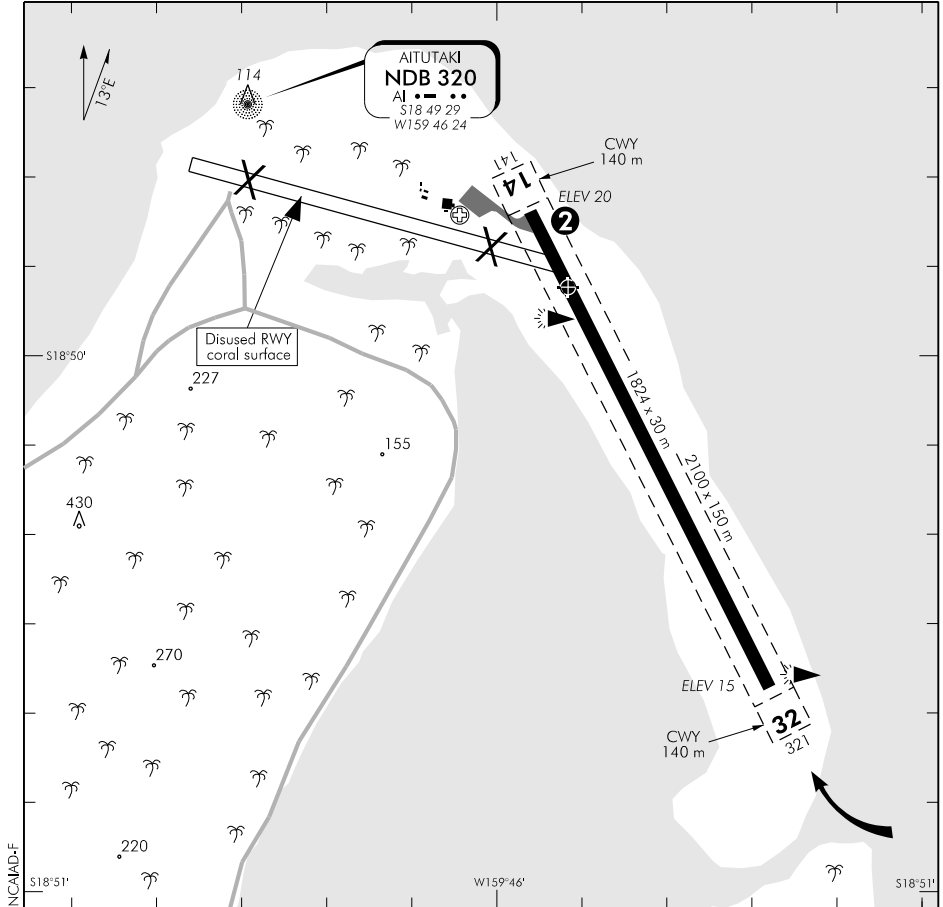


ELEV 20

NCAI

# AITUTAKI AERODROME

UNATTENDED: 118.1



Changes from 19 JUL 18: RWY 32 THR ELEV, strip width text and CWY added.

1. Circuit RWY 14 - Left hand  
RWY 32 - Right hand

- 2 Strip width narrows below 150 m in the first 120 m on north eastern side of RWY 14. Full length with reduced strip width available but restricted to daylight operations for aircraft 22,700 kg and below.

CIVIL IFR TAKE-OFF MINIMA			VFR MINIMA		
CEILING (ft) and VISIBILITY (m or km)			CEILING (ft) and VISIBILITY (m or km)		
RWY	DAY	NIGHT		DAY	NIGHT
14	800 – 4000		AIR TRANSPORT	1000 – 5	NA
32	800 – 4000		ALL OTHER	600 – 1500	NA

**Effective: 13 SEP 18**

S 18 49 52 W 159 45 50

© Government of Cook Islands

**AITUTAKI  
AERODROME**

**Intentionally  
Blank**

## NCAT AD 2.1 AERODROME LOCATION INDICATOR AND NAME

NCAT	ATIU
------	------

## NCAT AD 2.2 AERODROME GEOGRAPHICAL AND ADMINISTRATIVE DATA

<b>1</b>	ARP co-ordinates and site at AD	S 19 57 59.54 W 158 07 30.77 ARP site as depicted on NCAT AD 2-51.1
<b>2</b>	Direction and distance from city	Approximately 3km N of Teenui Village
<b>3</b>	Elevation/Reference temperature	46ft
<b>4</b>	MAG VAR/Annual change	14°E
<b>5</b>	AD Administration, address, telephone, telefax, telex, AFS	Proprietors of Enuamanu Airport Incorporation Atiu Cook Islands  Contact can be made through Air Rarotonga Tel (682) 22888
<b>6</b>	Types of traffic permitted (IFR/VFR)	IFR/VFR
<b>7</b>	Remarks	Available for limited use subject to prior agreement of the Licensee. No operations permitted on Sundays except for medical emergencies or non-commercial flights

**NCAT AD 2.3 OPERATIONAL HOURS**

<b>1</b>	AD Administration	0800–1600 Mon–Fri except public holidays
<b>2</b>	Customs and immigration	Nil
<b>3</b>	Health and sanitation	Hospital with limited facilities
<b>4</b>	AIS Briefing Office	Nil
<b>5</b>	ATS Reporting Office (ARO)	Nil
<b>6</b>	MET Briefing Office	Nil
<b>7</b>	ATS	Nil
<b>8</b>	Fuelling	Nil
<b>9</b>	Handling	Nil
<b>10</b>	Security	Nil
<b>11</b>	De-icing	Nil
<b>12</b>	Remarks	Atiu is an unattended aerodrome

**NCAT AD 2.4 HANDLING SERVICES AND FACILITIES**

<b>1</b>	Cargo-handling facilities	By prior arrangement through Air Rarotonga
<b>2</b>	Fuel/oil types	Nil
<b>3</b>	Fuelling facilities/capabilities	Nil
<b>4</b>	De-icing facilities	Nil
<b>5</b>	Hangar space for visiting aircraft	Nil
<b>6</b>	Repair facilities for visiting aircraft	Nil
<b>7</b>	Remarks	Nil

**NCAT AD 2.5 PASSENGER FACILITIES**

<b>1</b>	Hotels	Accommodation units available in town and around the island
<b>2</b>	Restaurants	Nil
<b>3</b>	Transportation	Transfers or by prior arrangement
<b>4</b>	Medical facilities	Hospital
<b>5</b>	Bank and Post Office	Available in town
<b>6</b>	Tourist Office	In town
<b>7</b>	Remarks	Nil

**NCAT AD 2.6 RESCUE AND FIRE FIGHTING SERVICES**

Nil

**NCAT AD 2.7 SEASONAL AVAILABILITY — CLEARING**

Nil

**NCAT AD 2.8 APRONS, TAXIWAYS AND CHECK LOCATIONS DATA**

<b>1</b>	Apron surface and strength	TBA
<b>2</b>	Taxiway width, surface and strength	Nil
<b>3</b>	ACL location and elevation	RWY 09 46ft RWY 27 44ft
<b>4</b>	VOR/INS checkpoints	Nil
<b>5</b>	Remarks	Nil

## NCAT AD 2.9 SURFACE MOVEMENT GUIDANCE, CONTROL SYSTEM AND MARKINGS

Nil

## NCAT AD 2.10 AERODROME OBSTACLES

In approach/TKOF areas			In circling area and at AD		Remarks
1			2		3
RWY/Area affected	Obstacle type Elevation Markings/ LGT	Coordinates	Obstacle type Elevation Markings/ LGT	Coordinates	
a	b	c	a	b	
09/27	TBA (1,b)	TBA (1,c)	TBA	TBA (2,b)	TBA
APRON	TBA (1,b)	TBA (1,c)	TBA	TBA (2,b)	

## NCAT AD 2.11 METEOROLOGICAL INFORMATION PROVIDED

Nil

**NCAT AD 2.12 RWY PHYSICAL CHARACTERISTICS**

<b>RWY</b>	<b>TRUE BRG</b>	<b>Dimension s of RWY (m)</b>	<b>Strength (PCN) and surface of RWY and SWY</b>	<b>THR coordinates</b>	<b>THR elevation and highest elevation of TDZ of precision APP RWY</b>
<b>1</b>	<b>2</b>	<b>3</b>	<b>4</b>	<b>5</b>	<b>6</b>
09	101°	1255 x 30	ESWL 20420kg Coral	S 19 58 00.31 W 158 07 32.14	46ft
27	281°	1255 x 30	ESWL 20420kg Coral	S 19 58 07.82 W 158 06 49.73	44ft

<b>Slope of RWY-SWY</b>	<b>SWY dimensions (m)</b>	<b>CWY Dimensions (m)</b>	<b>Strip dimensions (m)</b>	<b>OFZ</b>	<b>Remarks</b>
<b>7</b>	<b>8</b>	<b>9</b>	<b>10</b>	<b>11</b>	<b>12</b>
			1300 x 90		
			1300 x 90		

**NCAT AD 2.13 DECLARED DISTANCES**

<b>RWY</b>	<b>TORA (m)</b>	<b>TODA (m)</b>	<b>ASDA (m)</b>	<b>LDA (m)</b>	<b>Remarks</b>
<b>1</b>	<b>2</b>	<b>3</b>	<b>4</b>	<b>5</b>	<b>6</b>
09	1255	1255	1255	1255	
27	1255	1255	1255	1255	

**NCAT AD 2.14 APPROACH AND RWY LIGHTING**

Nil

**NCAT AD 2.15 OTHER LIGHTING, SECONDARY POWER SUPPLY**

Nil

**NCAT AD 2.16 HELICOPTER LANDING AREA**

Nil

**NCAT AD 2.17 ATS AIRSPACE**

<b>1</b>	Designation and lateral limits	Nil
<b>2</b>	Vertical limits	Nil
<b>3</b>	Airspace classification	Nil
<b>4</b>	ATS unit callsign, language(s)	Nil
<b>5</b>	Transition altitude	13000ft
<b>6</b>	Remarks	Nil



## **NCAT AD 2.18    ATS COMMUNICATIONS FACILITIES**

Nil

## **NCAT AD 2.19    RADIO NAVIGATION AND LANDING AIDS**

Nil

## **NCAT AD 2.20    LOCAL TRAFFIC REGULATIONS**

### **1        AERODROME REGULATIONS**

1.1    Pilots are to maintain a continuous listening watch on the frequency listed in the COM box on the aerodrome chart, or on 118.1MHz if there is no such chart.

1.2    For the benefit of other traffic, pilots should broadcast their position, altitude and intentions as listed below:

- (a)    In circuit: downwind when abeam the upwind end of the RWY.
- (b)    Established on finals to land.
- (c)    In transit: between 5–10NM from the aerodrome.

1.3    Each aircraft transmission is to be preceded by the name of the aerodrome, "ATIU TRAFFIC".

### **2        TAXIING TO AND FROM STANDS**

2.1    There are no taxiing stands or taxi routes. Taxi will be at the discretion of the pilot.

## **NCAT AD 2.21    NOISE ABATEMENT PROCEDURES**

There are no noise abatement procedures for Atiu.

## NCAT AD 2.22 FLIGHT PROCEDURES

### 1 POSITION AND ALTITUDE REPORTING — LOCAL VFR FLIGHTS

1.1 Pilots of aircraft intending to operate under VFR from Atiu are required to report departure details after take-off on the nominated HF frequencies to Rarotonga "TOWER/FLIGHT SERVICE" if intending to proceed to other unattended aerodromes or when requesting clearance to enter Class C airspace.

1.2 When Rarotonga Flight Service is operating Rarotonga CTA Class C airspace reverts to Class G.

### 2 POSITION REPORTING ON DEPARTURE

2.1 Pilots are required to make a departure report as soon as practicable after take-off on the nominated HF frequencies to Rarotonga "TOWER/FS" and must contain the following information in the order listed:

- (a) Identification; radio callsign
- (b) Estimated set heading time in minutes past the hour
- (c) Phrase "CLIMBING TO" or "REQUEST" followed by altitude or flight level;
- (d) Next position and time over or ETA for destination

2.2 When Rarotonga Flight Service is operating Rarotonga CTA Class C airspace reverts to Class G.

### 3 AERODROME TRAFFIC CIRCUIT RULES

3.1 Circuit direction is:

- (a) RWY 09 is left-hand
- (b) RWY 27 is right-hand

## NCAT AD 2.23 ADDITIONAL INFORMATION

Nil

## NCAT AD 2.24 CHARTS RELATED TO AERODROME

- (a) Instrument Approach Charts  
ATIU RNAV (GNSS) RWY 09 ..... NCAT AD 2-45.1
- (b) Aerodrome Charts  
ATIU ..... NCAT AD 2-51.1

ELEV 46

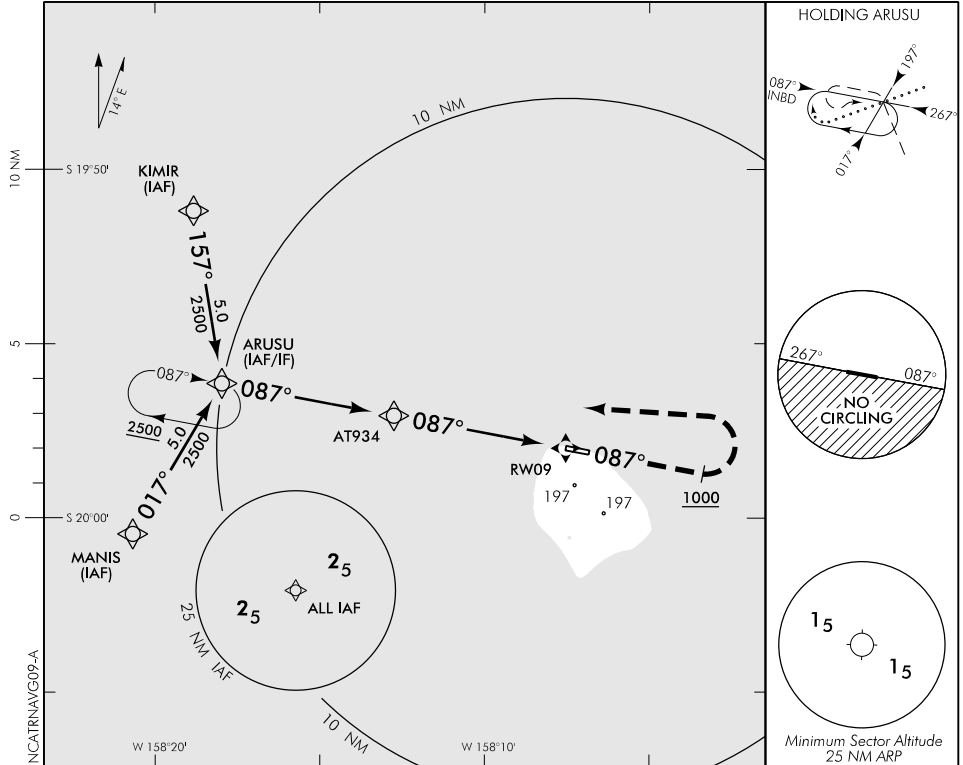
CAT A,B

**ATIU**

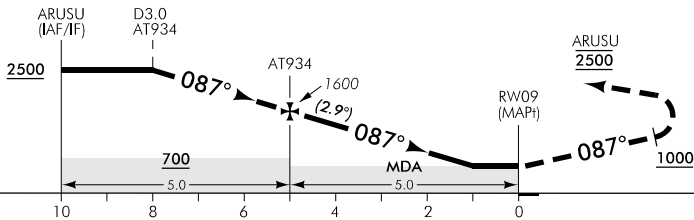
RWY 09 THR ELEV 46

**RNAV (GNSS) RWY 09**

UNATTENDED: 118.1



Use Atiu QNH or remote QNH



**MISSED APCH:** Track 087° to 1000, turn LEFT direct to ARUSU 2500

DISTANCE to WPT	ARUSU	4	3	2	1	AT934	4	3	2	1	RW09
Advisory Altitude 5%	3100	2800	2500	2200	1900	1600	1300	1000	700	MDA	MDA
Category	A			B			C			D	
RNAV	410(364) – 1600						NA				
Circling *	450(404) – 1900			540(494) – 2800			NA				

\* Circling NA south of RWY 09/27

**Effective: 25 MAY 17**

**Intentionally  
Blank**

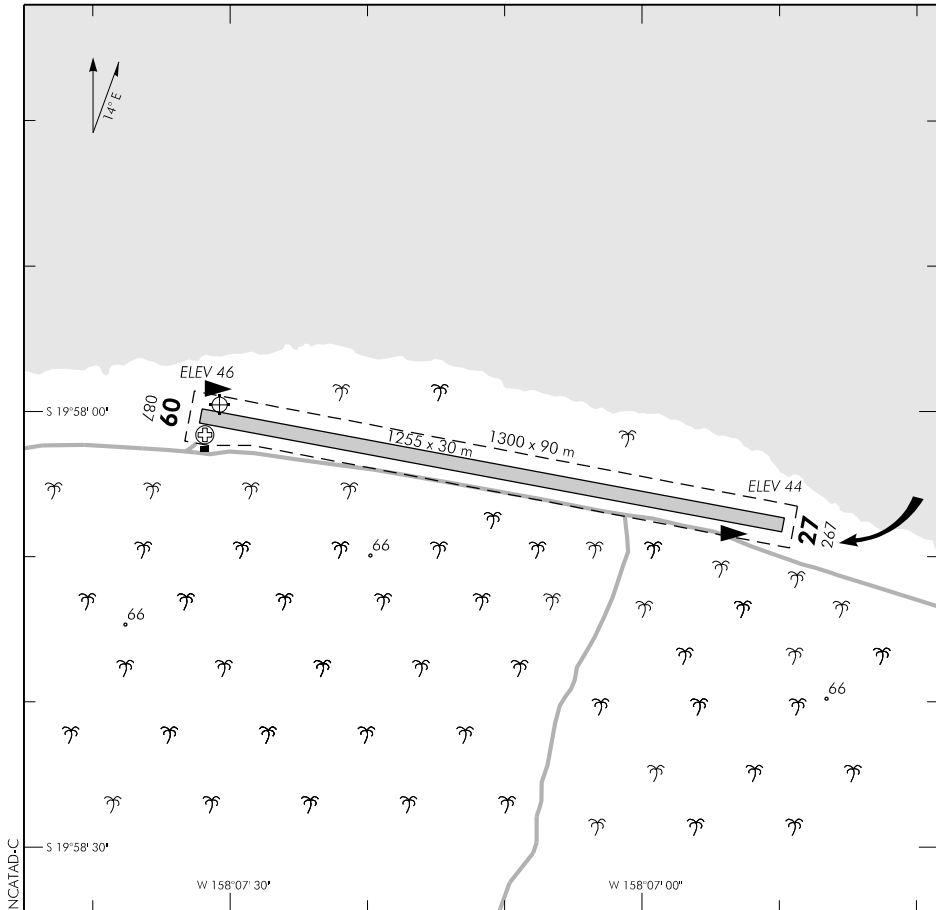
ELEV 46

NCAT

**ATIU**

**AERODROME**

UNATTENDED: 118.1



- 1. Circuit: RWY 09 – Left hand  
RWY 27 – Right hand

CIVIL IFR TAKE-OFF MINIMA			VFR MINIMA		
CEILING (ft) and VISIBILITY (m or km)			CEILING (ft) and VISIBILITY (m or km)		
RWY	DAY	NIGHT		DAY	NIGHT
09	600 – 2000	NA	AIR TRANSPORT	1000 – 5	NA
27	600 – 2000	NA	ALL OTHER	600 – 1500	NA

**Effective: 25 MAY 17**

S 19 58 00 W 158 07 31

© Government of Cook Islands

**ATIU**  
**AERODROME**

**Intentionally  
Blank**

## NCMG AD 2.1 AERODROME LOCATION INDICATOR AND NAME

<b>NCMG</b>	<b>MANGAIA</b>
-------------	----------------

## NCMG AD 2.2 AERODROME GEOGRAPHICAL AND ADMINISTRATIVE DATA

<b>1</b>	ARP co-ordinates and site at AD	S 21 53 37.48 W 157 54 30.63 ARP site as depicted on NCMG AD 2-51.1
<b>2</b>	Direction and distance from city	3km NNW of Ivirua village or 5.5km NE from Oneroa village
<b>3</b>	Elevation/Reference temperature	48ft
<b>4</b>	MAG VAR/Annual change	14°E
<b>5</b>	AD Administration, address, telephone, telefax, telex, AFS	Numangatini Ariki on behalf of the Aronga Mana of Mangaia Mangaia Island COOK ISLANDS
<b>6</b>	Types of traffic permitted (IFR/VFR)	IFR/VFR
<b>7</b>	Remarks	Available for limited use subject to prior agreement of the Licensee. No operations permitted on Sundays except for medical emergencies

**NCMG AD 2.3 OPERATIONAL HOURS**

<b>1</b>	AD Administration	0800–1600 Mon–Fri except public holidays
<b>2</b>	Customs and immigration	Nil
<b>3</b>	Health and sanitation	Hospital with limited facilities
<b>4</b>	AIS Briefing Office	Nil
<b>5</b>	ATS Reporting Office (ARO)	Nil
<b>6</b>	MET Briefing Office	Nil
<b>7</b>	ATS	Nil
<b>8</b>	Fuelling	Nil
<b>9</b>	Handling	Air Rarotonga
<b>10</b>	Security	Nil
<b>11</b>	De-icing	Nil
<b>12</b>	Remarks	Mangaia is an unattended aerodrome

**NCMG AD 2.4 HANDLING SERVICES AND FACILITIES**

<b>1</b>	Cargo-handling facilities	Air Rarotonga
<b>2</b>	Fuel/oil types	Nil
<b>3</b>	Fuelling facilities/capabilities	Nil
<b>4</b>	De-icing facilities	Nil
<b>5</b>	Hangar space for visiting aircraft	Nil
<b>6</b>	Repair facilities for visiting aircraft	Nil
<b>7</b>	Remarks	Nil



**NCMG AD 2.5 PASSENGER FACILITIES**

<b>1</b>	Hotels	Limited accommodation facilities
<b>2</b>	Restaurants	Nil
<b>3</b>	Transportation	By prior arrangement
<b>4</b>	Medical facilities	Hospital
<b>5</b>	Bank and Post Office	Town
<b>6</b>	Tourist Office	Nil
<b>7</b>	Remarks	Nil

**NCMG AD 2.6 RESCUE AND FIRE FIGHTING SERVICES**

Nil

**NCMG AD 2.7 SEASONAL AVAILABILITY — CLEARING**

Nil

**NCMG AD 2.8 APRONS, TAXIWAYS AND CHECK LOCATIONS DATA**

<b>1</b>	Apron surface and strength	Nil
<b>2</b>	Taxiway width, surface and strength	Nil
<b>3</b>	ACL location and elevation	RWY 13 45ft RWY 31 48ft
<b>4</b>	VOR/INS checkpoints	Nil
<b>5</b>	Remarks	Nil

## NCMG AD 2.9 SURFACE MOVEMENT GUIDANCE, CONTROL SYSTEM AND MARKINGS

Nil

## NCMG AD 2.10 AERODROME OBSTACLES

In approach/TKOF areas			In circling area and at AD		Remarks
1			2		3
RWY/Area affected	Obstacle type Elevation Markings/ LGT	Coordinates	Obstacle type Elevation Markings/ LGT	Coordinates	
a	b	c	a	b	
13/31	TBA (1,b)	TBA (1,c)	TBA	TBA (2,b)	TBA
APRON	TBA (1,b)	TBA (1,c)	TBA	TBA (2,b)	

## NCMG AD 2.11 METEOROLOGICAL INFORMATION PROVIDED

Nil

**NCMG AD 2.12 RWY PHYSICAL CHARACTERISTICS**

<b>RWY</b>	<b>TRUE BRG</b>	<b>Dimensions of RWY (m)</b>	<b>Strength (PCN) and surface of RWY and SWY</b>	<b>THR coordinates</b>	<b>THR elevation and highest elevation of TDZ of precision APP RWY</b>
<b>1</b>	<b>2</b>	<b>3</b>	<b>4</b>	<b>5</b>	<b>6</b>
13	145°	1011 x 30	ESWL 20420kg Coral	S 21 53 31.74 W 157 54 33.66	45ft
31	325°	1011 x 30	ESWL 20420kg Coral	S 21 53 58.60 W 157 54 13.37	48ft

<b>Slope of RWY-SWY</b>	<b>SWY dimensions (m)</b>	<b>CWY Dimensions (m)</b>	<b>Strip dimensions (m)</b>	<b>OFZ</b>	<b>Remarks</b>
<b>7</b>	<b>8</b>	<b>9</b>	<b>10</b>	<b>11</b>	<b>12</b>
			1060 x 80		
			1060 x 80		

**NCMG AD 2.13 DECLARED DISTANCES**

<b>RWY</b>	<b>TORA (m)</b>	<b>TODA (m)</b>	<b>ASDA (m)</b>	<b>LDA (m)</b>	<b>Remarks</b>
<b>1</b>	<b>2</b>	<b>3</b>	<b>4</b>	<b>5</b>	<b>6</b>
13	1011	1011	1011	1011	TODA EOL is taken from 1:40 gradient
31	1011	1011	1011	1011	TODA EOL is taken from 1:40 gradient

**NCMG AD 2.14 APPROACH AND RWY LIGHTING**

Nil

**NCMG AD 2.15 OTHER LIGHTING, SECONDARY POWER SUPPLY**

Nil

**NCMG AD 2.16 HELICOPTER LANDING AREA**

Nil

**NCMG AD 2.17 ATS AIRSPACE**

<b>1</b>	Designation and lateral limits	Nil
<b>2</b>	Vertical limits	Nil
<b>3</b>	Airspace classification	Nil
<b>4</b>	ATS unit callsign, language(s)	Nil
<b>5</b>	Transition altitude	13000ft
<b>6</b>	Remarks	Nil

## **NCMG AD 2.18 ATS COMMUNICATIONS FACILITIES**

Nil

## **NCMG AD 2.19 RADIO NAVIGATION AND LANDING AIDS**

Nil

## **NCMG AD 2.20 LOCAL TRAFFIC REGULATIONS**

### **1 AERODROME REGULATIONS**

1.1 Pilots are to maintain a continuous listening watch on the frequency listed in the COM box on the aerodrome chart, or on 118.1MHz.

1.2 For the benefit of other traffic, pilots should broadcast their position, altitude and intentions as listed below:

- (a) In circuit: downwind when abeam the upwind end of the RWY.
- (b) Established on finals to land.
- (c) In transit: between 5–10NM from the aerodrome.

1.3 Each aircraft transmission is to be preceded by the name of the aerodrome, "MANGAIA TRAFFIC".

### **2 TAXIING TO AND FROM STANDS**

2.1 There are no taxiing stands or taxi routes. Taxi will be at the discretion of the pilot.

## **NCMG AD 2.21 NOISE ABATEMENT PROCEDURES**

There are no published noise abatement procedures for Mangaia.

## NCMG AD 2.22 FLIGHT PROCEDURES

### 1 POSITION AND ALTITUDE REPORTING — LOCAL VFR FLIGHTS

1.1 Pilots of aircraft intending to operate under VFR from Mangaia are required to report departure details after take-off on the nominated HF frequencies to Rarotonga "TOWER/FLIGHT SERVICE" if intending to proceed to other aerodromes in the vicinity or when requesting clearance to enter Class C airspace.

1.2 When Rarotonga Flight Service is operating Rarotonga CTA Class C airspace reverts to Class G.

### 2 POSITION REPORTING ON DEPARTURE

2.1 Pilots are required to make a departure report as soon as practicable after take-off on the nominated HF frequencies to Rarotonga "TOWER/FLIGHT SERVICE" and must contain the following information:

- (a) Identification; radio callsign
- (b) Estimated set heading time in minutes past the hour
- (c) Phrase "CLIMBING TO" or "REQUEST" followed by altitude or flight level;
- (d) Next position and time over: or ETA at destination in minutes past the hour

2.2 When Rarotonga Flight Service is operating Rarotonga CTA Class C airspace reverts to Class G.

### 3 AERODROME TRAFFIC CIRCUIT RULES

3.1 Circuit direction is:

- (a) RWY 13 is left-hand
- (b) RWY 31 is right-hand

## NCMG AD 2.23 ADDITIONAL INFORMATION

TBA

## NCMG AD 2.24 CHARTS RELATED TO AERODROME

- (a) Instrument Approach Charts  
MANGAIA RNAV (GNSS) RWY 13 ..... NCMG AD 2-45.1
- (b) Aerodrome Charts  
MANGAIA ..... NCMG AD 2-51.1

ELEV 48

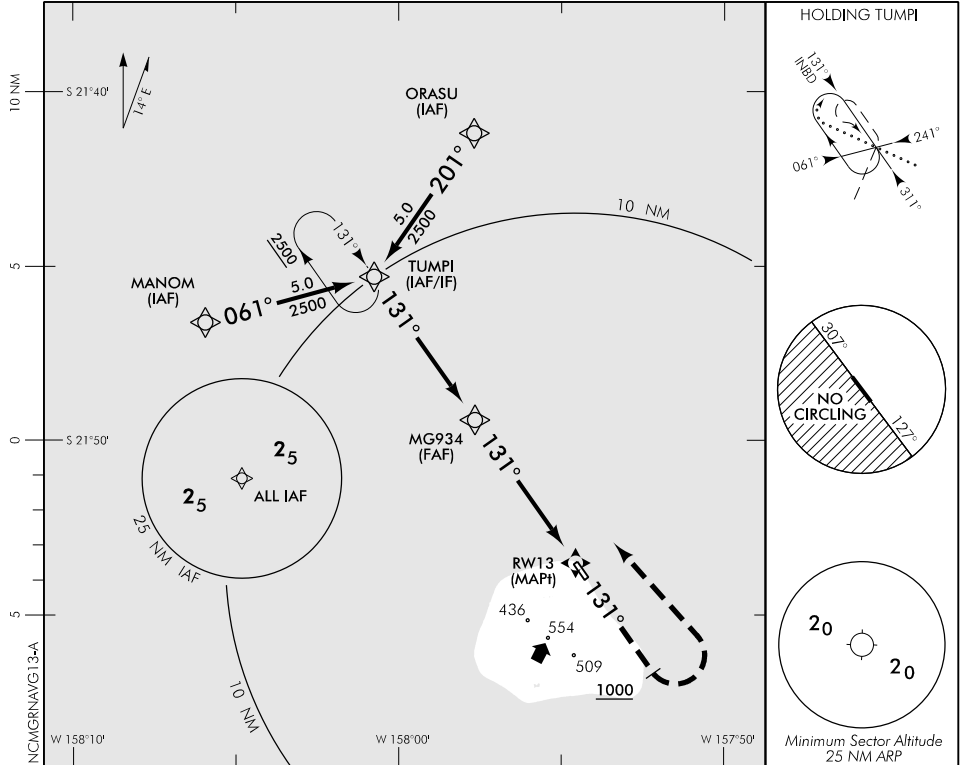
CAT A,B

# MANGAIA

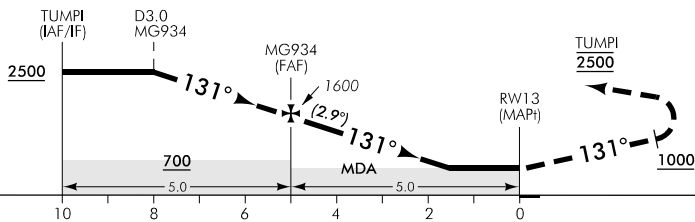
RWY 13 THR ELEV 45

## RNAV (GNSS) RWY 13

UNATTENDED: 118.1



Use Mangaia QNH or remote QNH



**MISSED APCH:** Track 131° to 1000, turn LEFT direct to TUMPI 2500

DISTANCE to WPT	TUMPI	4	3	2	1	MG934	4	3	2	1.6	RW13
Advisory Altitude 5%	3100	2800	2500	2200	1900	1600	1300	1000	700	MDA	MDA
Category	A		B			C			D		
LNAV	590(542) – 2000						NA				
Circling *	590(542) – 2000			610(562) – 2800			NA				

\* Circling NA west of RWY 13/31

Effective: 25 MAY 17

New chart.

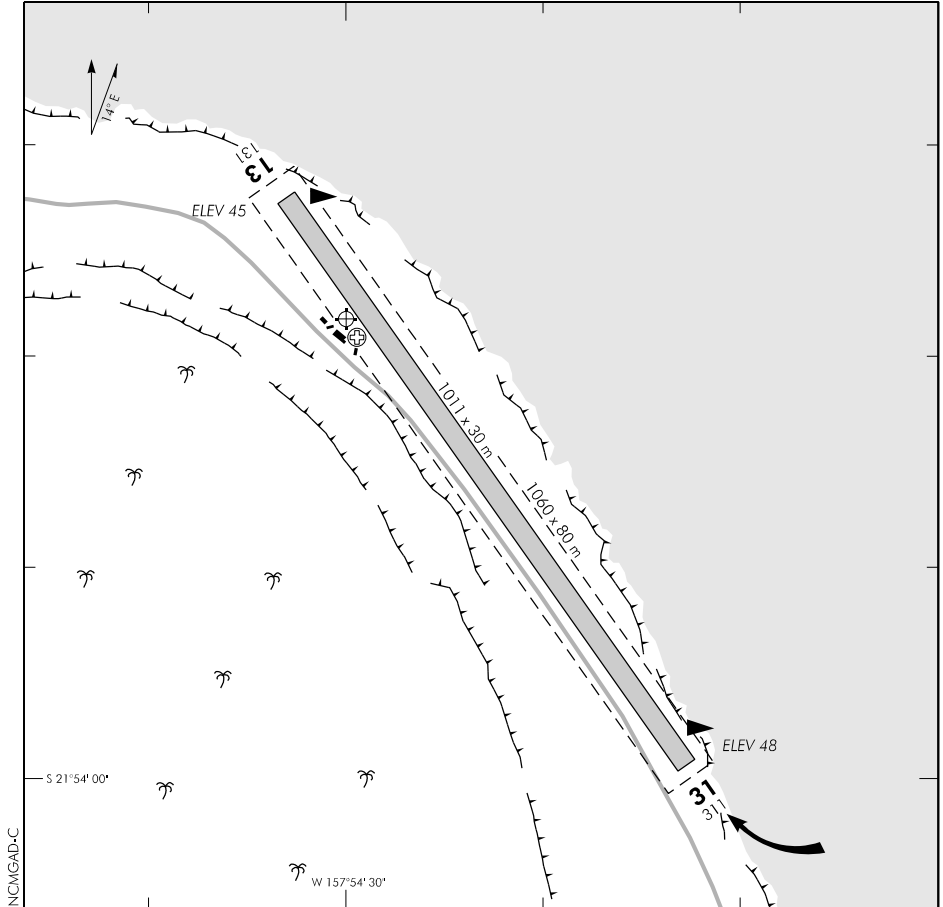
**Intentionally  
Blank**



ELEV 48  
NCMG

**MANGAIA  
AERODROME**

UNATTENDED: 118.1



Changes from 30 APR 15: Aerodrome elevations, RWY length, ARP.

- 1. Circuit: RWY 13 – Left hand  
RWY 31 – Right hand

CIVIL IFR TAKE-OFF MINIMA			VFR MINIMA		
CEILING (ft) and VISIBILITY (m or km)			CEILING (ft) and VISIBILITY (m or km)		
RWY	DAY	NIGHT		DAY	NIGHT
13-31	NA	NA	AIR TRANSPORT	1000 – 5	NA
			ALL OTHER	600 – 1500	NA

**Effective: 25 MAY 17**

S 21 53 37 W 157 54 31

© Government of Cook Islands

**MANGAIA  
AERODROME**

**Intentionally  
Blank**

## NCMH AD 2.1 AERODROME LOCATION INDICATOR AND NAME

NCMH	MANIHIKI
------	----------

## NCMH AD 2.2 AERODROME GEOGRAPHICAL AND ADMINISTRATIVE DATA

<b>1</b>	ARP co-ordinates and site at AD	S10 22 46.02 W161 00 02.66 ARP site as depicted on NCMH AD 2-51.1
<b>2</b>	Direction and distance from city	APRX 700m E of Tukao
<b>3</b>	Elevation/Reference temperature	11ft
<b>4</b>	MAG VAR/Annual change	11°E
<b>5</b>	AD Administration, address, telephone, telefax, telex, AFS	Manihiki Island Council Manihiki COOK ISLANDS Ph: 43 103 or 43 607
<b>6</b>	Types of traffic permitted (IFR/VFR)	IFR/VFR
<b>7</b>	Remarks	Private flights subject to prior agreement of the Licensee. No operations permitted on Sundays except for medical emergencies

**NCMH AD 2.3 OPERATIONAL HOURS**

<b>1</b>	AD Administration	0800–1600 Mon–Fri except public holidays
<b>2</b>	Customs and immigration	Nil
<b>3</b>	Health and sanitation	Hospital with limited facilities
<b>4</b>	AIS Briefing Office	Nil
<b>5</b>	ATS Reporting Office (ARO)	Nil
<b>6</b>	MET Briefing Office	Nil
<b>7</b>	ATS	Nil
<b>8</b>	Fuelling	Nil
<b>9</b>	Handling	Air Rarotonga
<b>10</b>	Security	Nil
<b>11</b>	De-icing	Nil
<b>12</b>	Remarks	Manihiki is an unattended aerodrome

**NCMH AD 2.4 HANDLING SERVICES AND FACILITIES**

<b>1</b>	Cargo-handling facilities	Nil
<b>2</b>	Fuel/oil types	Nil
<b>3</b>	Fuelling facilities/capabilities	Nil
<b>4</b>	De-icing facilities	Nil
<b>5</b>	Hangar space for visiting aircraft	Nil
<b>6</b>	Repair facilities for visiting aircraft	Nil
<b>7</b>	Remarks	Nil

**NCMH AD 2.5 PASSENGER FACILITIES**

<b>1</b>	Hotels	Nil
<b>2</b>	Restaurants	Nil
<b>3</b>	Transportation	By arrangement
<b>4</b>	Medical facilities	Nil
<b>5</b>	Bank and Post Office	Nil
<b>6</b>	Tourist Office	Nil
<b>7</b>	Remarks	Nil

**NCMH AD 2.6 RESCUE AND FIRE FIGHTING SERVICES**

Nil

**NCMH AD 2.7 SEASONAL AVAILABILITY — CLEARING**

Nil

**NCMH AD 2.8 APRONS, TAXIWAYS AND CHECK LOCATIONS DATA**

<b>1</b>	Apron surface and strength	Concrete parking pad
<b>2</b>	Taxiway width, surface and strength	Nil
<b>3</b>	ACL location and elevation	TBA
<b>4</b>	VOR/INS checkpoints	Nil
<b>5</b>	Remarks	Nil

## NCMH AD 2.9 SURFACE MOVEMENT GUIDANCE, CONTROL SYSTEM AND MARKINGS

Nil

## NCMH AD 2.10 AERODROME OBSTACLES

In approach/TKOF areas			In circling area and at AD		Remarks
1			2		3
RWY/Area affected	Obstacle type Elevation Markings/ LGT	Coordinates	Obstacle type Elevation Markings/ LGT	Coordinates	
a	b	c	a	b	
14/32	TBA (1,b)	TBA (1,c)	TBA	TBA (2,b)	TBA
APRON	TBA (1,b)	TBA (1,c)	TBA	TBA (2,b)	

## NCMH AD 2.11 METEOROLOGICAL INFORMATION PROVIDED

Nil

**NCMH AD 2.12 RWY PHYSICAL CHARACTERISTICS**

<b>RWY</b>	<b>TRUE BRG</b>	<b>Dimensions of RWY (m)</b>	<b>Strength (PCN) and surface of RWY and SWY</b>	<b>THR coordinates</b>	<b>THR elevation and highest elevation of TDZ of precision APP RWY</b>
<b>1</b>	<b>2</b>	<b>3</b>	<b>4</b>	<b>5</b>	<b>6</b>
14	149°	1700 x 30	ESWL 20420kg Coral	S 10 22 32.40 W 161 00 08.99	11ft
32	329°	1700 x 30	ESWL 20420kg Coral	S 10 23 11.30 W 160 59 45.65	9ft

<b>Slope of RWY-SWY</b>	<b>SWY dimensions (m)</b>	<b>CWY Dimensions (m)</b>	<b>Strip dimensions (m)</b>	<b>OFZ</b>	<b>Remarks</b>
<b>7</b>	<b>8</b>	<b>9</b>	<b>10</b>	<b>11</b>	<b>12</b>
		50	1800 x 90		
		50	1800 x 90		

**NCMH AD 2.13 DECLARED DISTANCES**

<b>RWY</b>	<b>TORA (m)</b>	<b>TODA (m)</b>	<b>ASDA (m)</b>	<b>LDA (m)</b>	<b>Remarks</b>
<b>1</b>	<b>2</b>	<b>3</b>	<b>4</b>	<b>5</b>	<b>6</b>
14	1700	1750	1700	1550	DISP THR 150m
32	1700	1750	1700	1540	DISP THR 160m

**NCMH AD 2.14 APPROACH AND RWY LIGHTING**

Nil

**NCMH AD 2.15 OTHER LIGHTING, SECONDARY POWER SUPPLY**

Nil

**NCMH AD 2.16 HELICOPTER LANDING AREA**

Nil

**NCMH AD 2.17 ATS AIRSPACE**

<b>1</b>	Designation and lateral limits	Nil
<b>2</b>	Vertical limits	Nil
<b>3</b>	Airspace classification	Nil
<b>4</b>	ATS unit callsign, language(s)	Nil
<b>5</b>	Transition altitude	13000ft
<b>6</b>	Remarks	Nil



## **NCMH AD 2.18 ATS COMMUNICATIONS FACILITIES**

Nil

## **NCMH AD 2.19 RADIO NAVIGATION AND LANDING AIDS**

Nil

## **NCMH AD 2.20 LOCAL TRAFFIC REGULATIONS**

### **1 AERODROME REGULATIONS**

1.1 Pilots are to maintain a continuous listening watch on the frequency listed in the COM box on the aerodrome chart, or on 118.1MHz if there is no such chart.

1.2 For the benefit of other traffic, pilots should broadcast their position, altitude and intentions as listed below:

- (a) In circuit: downwind when abeam the upwind end of the RWY.
- (b) Established on finals to land.
- (c) In transit: between 5–10NM from the aerodrome.

1.3 Each aircraft transmission is to be preceded by the name of the aerodrome, "MANIHIKI TRAFFIC".

### **2 TAXIING TO AND FROM STANDS**

2.1 There are no taxiing stands or taxi routes. Taxi will be at the discretion of the pilot.

## **NCMH AD 2.21 NOISE ABATEMENT PROCEDURES**

There are no published noise abatement procedures for Manihiki.

## NCMH AD 2.22 FLIGHT PROCEDURES

### 1 POSITION AND ALTITUDE REPORTING — LOCAL VFR FLIGHTS

1.1 Pilots of aircraft intending to operate under VFR from Manihiki are required to report departure details after take-off on the nominated HF frequencies to Rarotonga "TOWER/FLIGHT SERVICE" if intending to proceed to other unattended aerodromes in the vicinity.

### 2 POSITION REPORTING ON DEPARTURE

2.1 Pilots are required to make a departure report as soon as practicable after take-off on the nominated HF frequencies to Rarotonga "TOWER/FLIGHT SERVICE" and must contain the following information in the order listed:

- (a) Identification; radio callsign
- (b) Estimated set heading time in minutes past the hour
- (c) Phrase "CLIMBING TO" or "REQUEST" followed by altitude or flight level;
- (d) Next position and time over or ETA for destination

### 3 AERODROME TRAFFIC CIRCUIT RULES

3.1 Circuit direction is:

- (a) RWY 14 is left-hand
- (b) RWY 32 is right-hand

## NCMH AD 2.23 ADDITIONAL INFORMATION

Nil

## NCMH AD 2.24 CHARTS RELATED TO AERODROME

- (a) Instrument Approach Charts
  - MANIHIKI RNAV (GNSS) RWY 14 ..... NCMH AD 2-45.1
  - MANIHIKI RNAV (GNSS) RWY 32 ..... NCMH AD 2-45.2
- (b) Aerodrome Charts
  - MANIHIKI ..... NCMH AD 2-51.1

ELEV 11

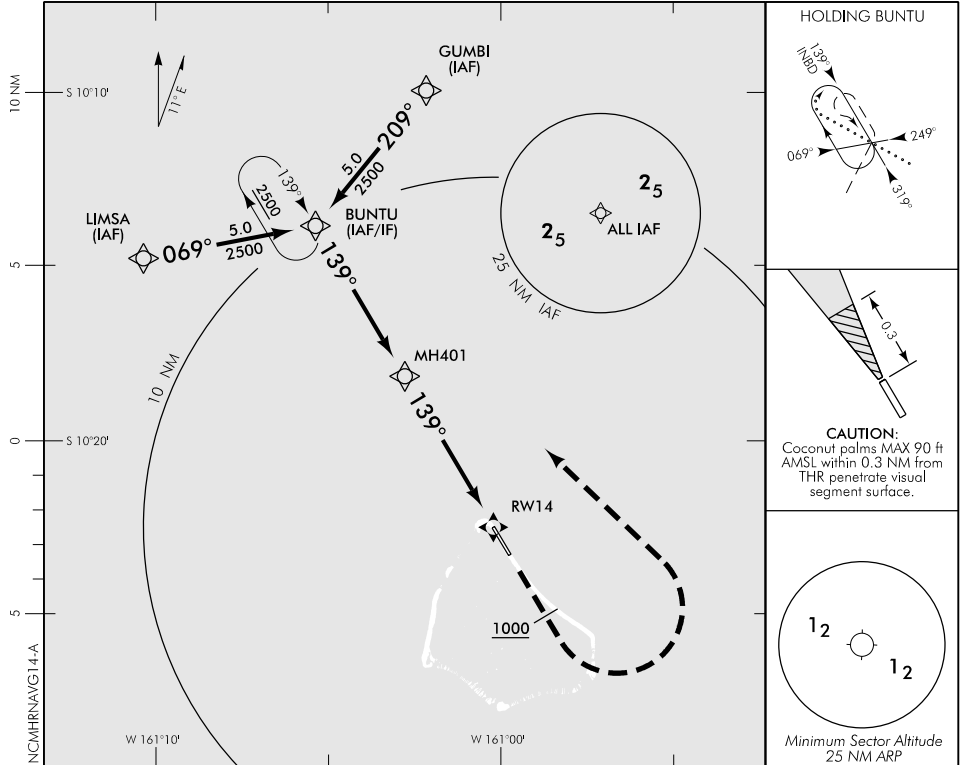
CAT A,B

**MANIHIKI**

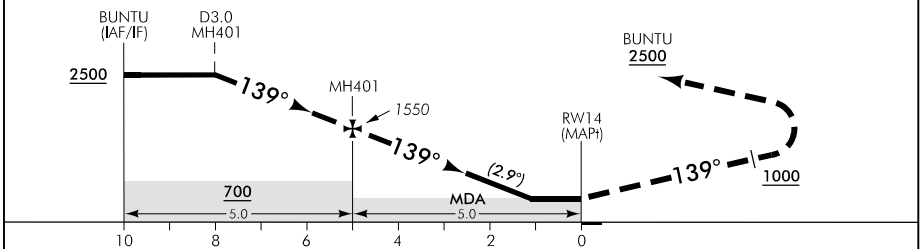
RWY 14 THR ELEV 11

**RNAV (GNSS) RWY 14**

UNATTENDED: 118.1



Use Manihiki QNH or remote QNH



**MISSED APCH:** Track 139° to 1000, turn LEFT direct to BUNTU 2500

DISTANCE to WPT	BUNTU	4	3	2	1	MH401	4	3	2	1.1	RWY14
Advisory Altitude 5%	3050	2750	2450	2150	1850	1550	1250	950	650	MDA	MDA
Category	A			B			C		D		
LNAV*	400(389) – 1600						NA				
Circling	450(439) – 1900			510(499) – 2800			NA				

\* Non-compliant with ICAO PANS-OPS straight-in criteria. VSS penetrated – See caution note.

**Effective: 6 DEC 18**

New chart.

ELEV 11

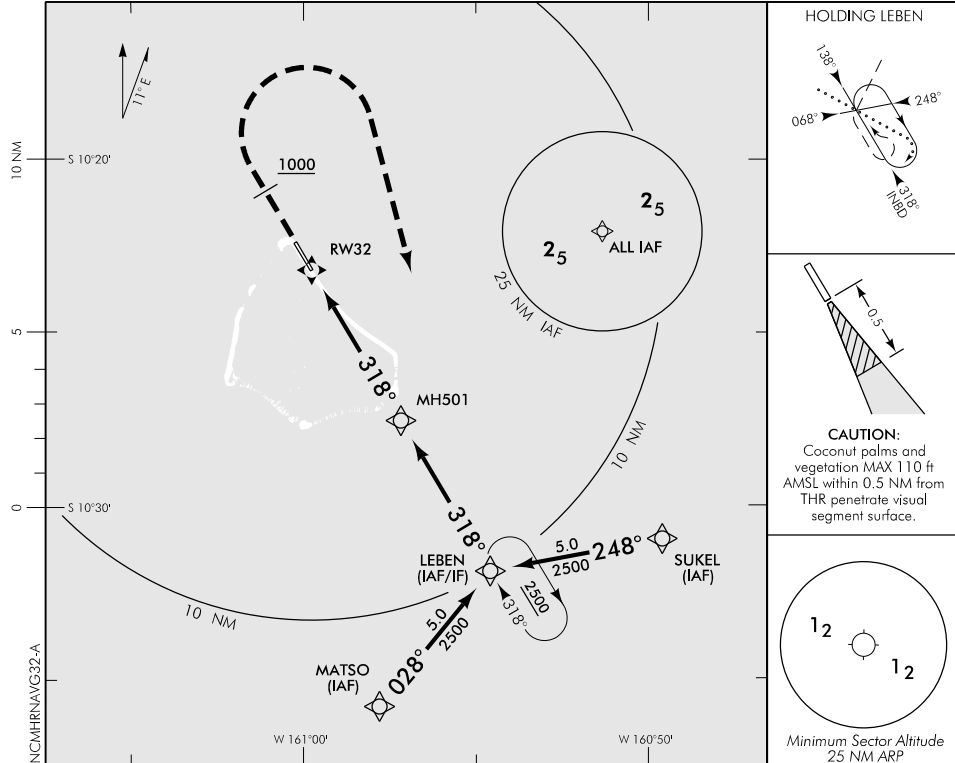
CAT A,B

RWY 32 THR ELEV 9

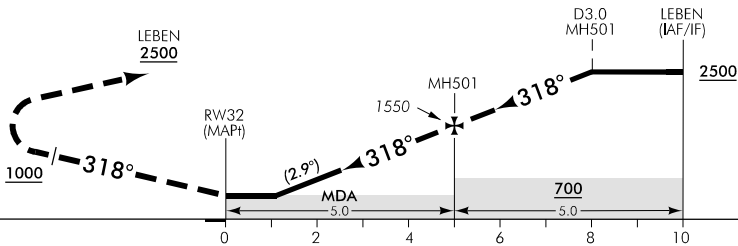
# MANIHIKI

## RNAV (GNSS) RWY 32

UNATTENDED: 118.1



Use Manihiki QNH or remote QNH



New chart.

**MISSED APCH:** Track 318° to 1000, turn RIGHT direct to LEBEN 2500

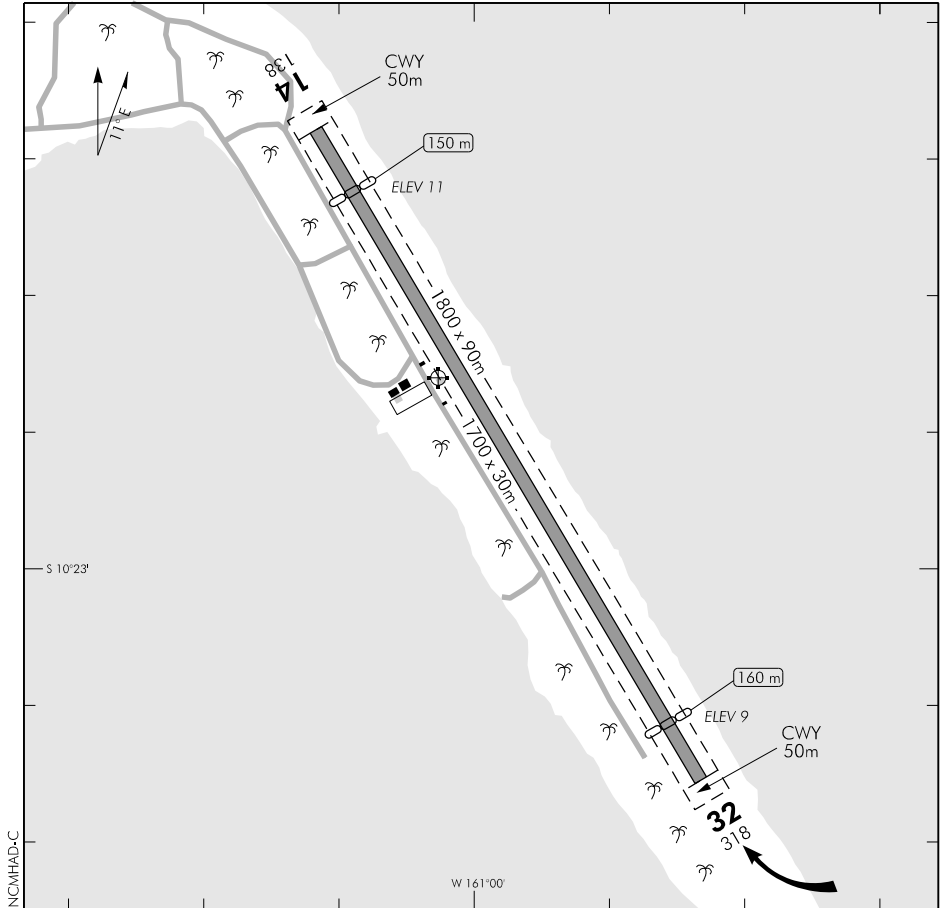
DISTANCE to WPT	RW32	1.1	2	3	4	MH501	1	2	3	4	LEBEN
Advisory Altitude 5%	MDA	MDA	650	950	1250	1550	1850	2150	2450	2750	3050
Category	A		B			C			D		
RNAV*	400(391) – 1600					NA					
Circling	450(441) – 1900			510(501) – 2800			NA				

\* Non-compliant with ICAO PANS-OPS straight-in criteria. VSS penetrated – See caution note

ELEV 11  
NCMH

**MANIHIKI  
AERODROME**

UNATTENDED: 118.1



- 1. Circuit: RWY 14 – Left hand  
RWY 32 – Right hand

CIVIL IFR TAKE-OFF MINIMA			VFR MINIMA		
CEILING (ft) and VISIBILITY (m or km)			CEILING (ft) and VISIBILITY (m or km)		
RWY	DAY	NIGHT		DAY	NIGHT
14	500 – 2000	NA	AIR TRANSPORT	1000 – 5	NA
32	500 – 2000	NA	ALL OTHER	600 – 1500	NA

**Effective: 6 DEC 18**

**Intentionally  
Blank**

## NCMK AD 2.1 AERODROME LOCATION INDICATOR AND NAME

NCMK	MAUKE
------	-------

## NCMK AD 2.2 AERODROME GEOGRAPHICAL AND ADMINISTRATIVE DATA

<b>1</b>	ARP co-ordinates and site at AD	S 20 08 14.35 W 157 20 37.87 ARP site as depicted on NCMK AD 2-51.1
<b>2</b>	Direction and distance from city	1.5km NE of town
<b>3</b>	Elevation/Reference temperature	38ft
<b>4</b>	MAG VAR/Annual change	14°E
<b>5</b>	AD Administration, address, telephone, telefax, telex, AFS	Mauke Island Council Mauke COOK ISLANDS  Contact can be made through Air Rarotonga Agent Tel (682) 22 888
<b>6</b>	Types of traffic permitted (IFR/VFR)	IFR/VFR
<b>7</b>	Remarks	Available for limited use subject to prior agreement of the Licensee. No operations permitted on Sundays except for medical emergencies

**NCMK AD 2.3 OPERATIONAL HOURS**

<b>1</b>	AD Administration	0800–1600 Mon–Fri except public holidays
<b>2</b>	Customs and immigration	Nil
<b>3</b>	Health and sanitation	Hospital with limited facilities
<b>4</b>	AIS Briefing Office	Nil
<b>5</b>	ATS Reporting Office (ARO)	Nil
<b>6</b>	MET Briefing Office	Nil
<b>7</b>	ATS	Nil
<b>8</b>	Fuelling	Nil
<b>9</b>	Handling	Air Rarotonga
<b>10</b>	Security	Nil
<b>11</b>	De-icing	Nil
<b>12</b>	Remarks	Mauke is an unattended aerodrome

**NCMK AD 2.4 HANDLING SERVICES AND FACILITIES**

<b>1</b>	Cargo-handling facilities	By prior arrangement with Air Rarotonga
<b>2</b>	Fuel/oil types	Nil
<b>3</b>	Fuelling facilities/capabilities	Nil
<b>4</b>	De-icing facilities	Nil
<b>5</b>	Hangar space for visiting aircraft	Nil
<b>6</b>	Repair facilities for visiting aircraft	Nil
<b>7</b>	Remarks	Nil



**NCMK AD 2.5 PASSENGER FACILITIES**

<b>1</b>	Hotels	Accommodation units available near airport and around the island
<b>2</b>	Restaurants	Nil
<b>3</b>	Transportation	Transfers or by prior arrangement
<b>4</b>	Medical facilities	Hospital
<b>5</b>	Bank and Post Office	Available in town
<b>6</b>	Tourist Office	Nil
<b>7</b>	Remarks	Nil

**NCMK AD 2.6 RESCUE AND FIRE FIGHTING SERVICES**

Nil

**NCMK AD 2.7 SEASONAL AVAILABILITY — CLEARING**

Nil

**NCMK AD 2.8 APRONS, TAXIWAYS AND CHECK LOCATIONS DATA**

<b>1</b>	Apron surface and strength	Compact coral
<b>2</b>	Taxiway width, surface and strength	Nil
<b>3</b>	ACL location and elevation	RWY 10 32ft RWY 28 32ft
<b>4</b>	VOR/INS checkpoints	Nil
<b>5</b>	Remarks	Nil

## NCMK AD 2.9 SURFACE MOVEMENT GUIDANCE, CONTROL SYSTEM AND MARKINGS

Nil

## NCMK AD 2.10 AERODROME OBSTACLES

In approach/TKOF areas			In circling area and at AD		Remarks
1			2		3
RWY/Area affected	Obstacle type Elevation Markings/ LGT	Coordinates	Obstacle type Elevation Markings/ LGT	Coordinates	
a	b	c	a	b	
10/28	TBA (1,b)	TBA (1,c)	TBA	TBA (2,b)	TBA
APRON	TBA (1,b)	TBA (1,c)	TBA	TBA (2,b)	

## NCMK AD 2.11 METEOROLOGICAL INFORMATION PROVIDED

Nil

**NCMK AD 2.12 RWY PHYSICAL CHARACTERISTICS**

<b>RWY</b>	<b>TRUE BRG</b>	<b>Dimensions of RWY (m)</b>	<b>Strength (PCN) and surface of RWY and SWY</b>	<b>THR coordinates</b>	<b>THR elevation and highest elevation of TDZ of precision APP RWY</b>
<b>1</b>	<b>2</b>	<b>3</b>	<b>4</b>	<b>5</b>	<b>6</b>
10	113°	1592 x 30	ESWL 20420kg Coral	S 20 08 01.22 W 157 21 06.83	32ft
28	293°	1592 x 30	ESWL 20420kg Coral	S 20 08 21.46 W 157 20 16.36	32ft

<b>Slope of RWY-SWY</b>	<b>SWY dimensions (m)</b>	<b>CWY Dimensions (m)</b>	<b>Strip dimensions (m)</b>	<b>OFZ</b>	<b>Remarks</b>
<b>7</b>	<b>8</b>	<b>9</b>	<b>10</b>	<b>11</b>	<b>12</b>
1.80U		200	1800 x 90		
0.60U			1800 x 90		

**NCMK AD 2.13 DECLARED DISTANCES**

<b>RWY</b>	<b>TORA (m)</b>	<b>TODA (m)</b>	<b>ASDA (m)</b>	<b>LDA (m)</b>	<b>Remarks</b>
<b>1</b>	<b>2</b>	<b>3</b>	<b>4</b>	<b>5</b>	<b>6</b>
10	1592	1792	1592	1592	
28	1592	1592	1592	1592	

**NCMK AD 2.14 APPROACH AND RWY LIGHTING**

Nil

**NCMK AD 2.15 OTHER LIGHTING, SECONDARY POWER SUPPLY**

Nil

**NCMK AD 2.16 HELICOPTER LANDING AREA**

Nil

**NCMK AD 2.17 ATS AIRSPACE**

<b>1</b>	Designation and lateral limits	Nil
<b>2</b>	Vertical limits	Nil
<b>3</b>	Airspace classification	Nil
<b>4</b>	ATS unit callsign, language(s)	Nil
<b>5</b>	Transition altitude	13000ft
<b>6</b>	Remarks	Nil

## **NCMK AD 2.18 ATS COMMUNICATIONS FACILITIES**

Nil

## **NCMK AD 2.19 RADIO NAVIGATION AND LANDING AIDS**

Nil

## **NCMK AD 2.20 LOCAL TRAFFIC REGULATIONS**

### **1 AERODROME REGULATIONS**

1.1 Pilots are to maintain a continuous listening watch on the frequency listed in the COM box on the aerodrome chart, or on 118.1MHz if there is no such chart.

1.2 For the benefit of other traffic, pilots should broadcast their position, altitude and intentions as listed below:

- (a) In circuit: downwind when abeam the upwind end of the RWY.
- (b) Established on finals to land.
- (c) In transit: between 5–10NM from the aerodrome.

1.3 Each aircraft transmission is to be preceded by the name of the aerodrome, "MAUKE TRAFFIC".

### **2 TAXIING TO AND FROM STANDS**

2.1 There are no taxiing stands or taxi routes. Taxi will be at the discretion of the pilot.

## **NCMK AD 2.21 NOISE ABATEMENT PROCEDURES**

There are no published noise abatement procedures for Mauke.

## NCMK AD 2.22 FLIGHT PROCEDURES

### 1 POSITION AND ALTITUDE REPORTING — LOCAL VFR FLIGHTS

1.1 Pilots of aircraft intending to operate under VFR from Mauke are required to report departure details after take-off on the nominated HF frequencies to Rarotonga "TOWER/FLIGHT SERVICE" if intending to proceed to other unattended aerodromes or when requesting clearance to enter Class C airspace.

1.2 When Rarotonga Flight Service is operating Rarotonga CTA Class C airspace reverts to Class G.

### 2 POSITION REPORTING ON DEPARTURE

2.1 Pilots are required to make a departure report as soon as practicable after take-off on the nominated HF frequencies to Rarotonga "TOWER/FLIGHT SERVICE" and must contain the following information:

- (a) Identification; radio callsign
- (b) Estimated set heading time in minutes past the hour
- (c) Phrase "CLIMBING TO" or "REQUEST" followed by altitude or flight level;
- (d) Next position and time over or ETA for destination

2.2 When Rarotonga Flight Service is operating Rarotonga CTA Class C airspace reverts to Class G.

### 3 AERODROME TRAFFIC CIRCUIT RULES

3.1 Circuit direction is:

- (a) RWY 10 is left-hand
- (b) RWY 28 is right-hand

## NCMK AD 2.23 ADDITIONAL INFORMATION

Nil

## NCMK AD 2.24 CHARTS RELATED TO AERODROME

- (a) Instrument Approach Charts
  - MAUKE RNAV (GNSS) RWY 10 ..... NCMK AD 2-45.1
- (b) Aerodrome Charts
  - MAUKE ..... NCMK AD 2-51.1

ELEV 38

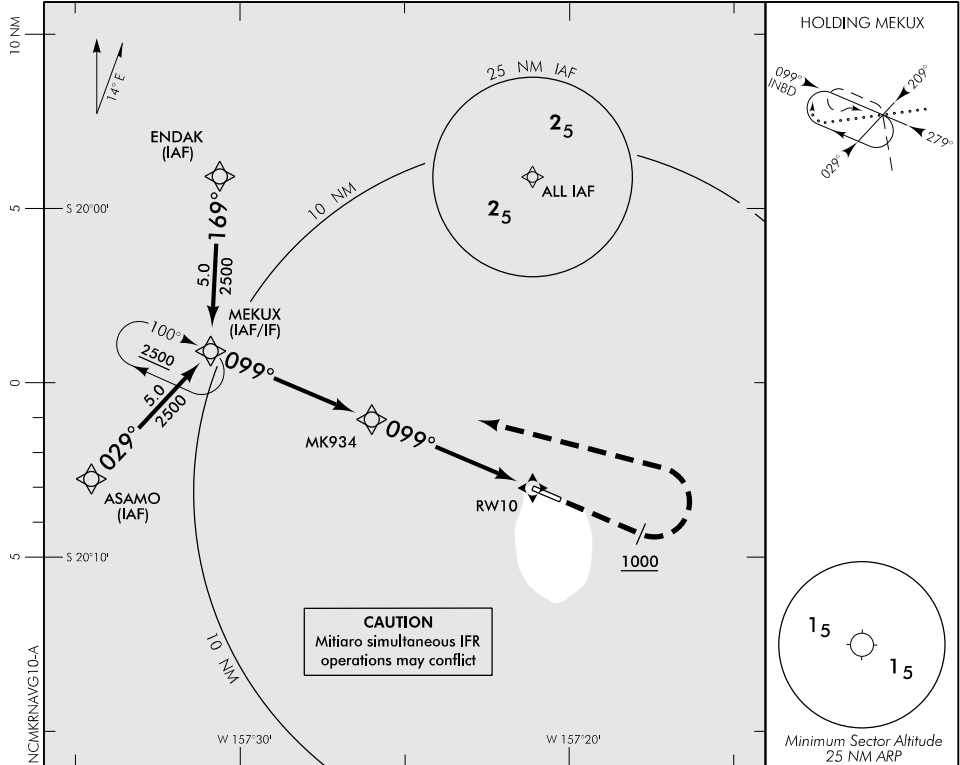
CAT A,B

**MAUKE**

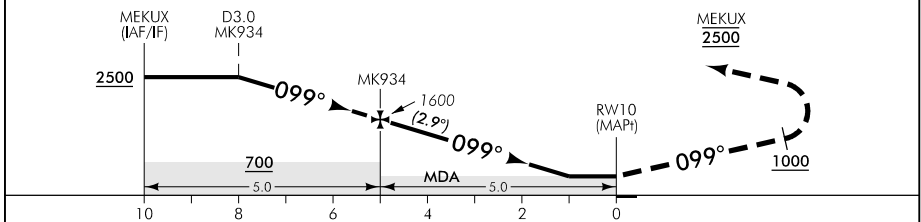
RWY 10 THR ELEV 32

**RNAV (GNSS) RWY 10**

UNATTENDED: 118.1



Use Mauke QNH or remote QNH



**MISSED APCH:** Track 099° to 1000, turn LEFT direct to MEKUX 2500

DISTANCE TO WPT	MEKUX	4	3	2	1	MK934	4	3	2	1	RW10
Advisory Altitude 5%	3100	2800	2500	2200	1900	1600	1300	1000	700	MDA	MDA
Category	A		B				C		D		
LNAV	400(362) – 1600						NA				
Circling	480(442) – 1900			540(502) – 2800			NA				

Effective: 25 MAY 17

**Intentionally  
Blank**

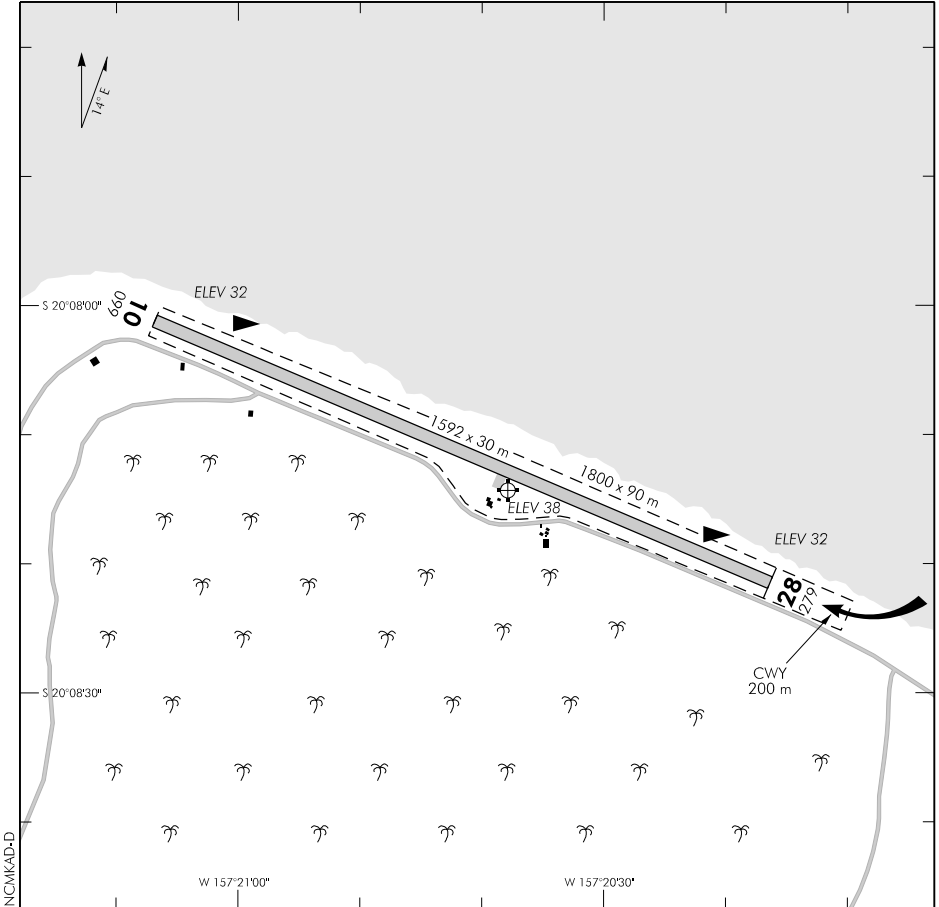


ELEV 38

NCMK

**MAUKE  
AERODROME**

UNATTENDED: 118.1



Changes from 25 MAY 17: RWY 10/28 DISP THRs removed.

1. Circuit: RWY 10 – Left hand  
RWY 28 – Right hand
2. Strip slopes up from both ends.

CIVIL IFR TAKE-OFF MINIMA			VFR MINIMA		
CEILING (ft) and VISIBILITY (m or km)			CEILING (ft) and VISIBILITY (m or km)		
RWY	DAY	NIGHT		DAY	NIGHT
10-28	NA	NA	AIR TRANSPORT	1000 – 5	NA
			ALL OTHER	600 – 1500	NA

**Effective: 19 JUL 18**

**Intentionally  
Blank**

## NCMR AD 2.1 AERODROME LOCATION INDICATOR AND NAME

NCMR	MITIARO
------	---------

## NCMR AD 2.2 AERODROME GEOGRAPHICAL AND ADMINISTRATIVE DATA

<b>1</b>	ARP co-ordinates and site at AD	S 19 50 27.89 W 157 42 37.42 ARP site as depicted on NCMR AD 2-51.1
<b>2</b>	Direction and distance from city	2.5km NE of the village
<b>3</b>	Elevation/Reference temperature	33ft
<b>4</b>	MAG VAR/Annual change	13°E
<b>5</b>	AD Administration, address, telephone, telefax, telex, AFS	Mitiaro Island Council Mitiaro COOK ISLANDS
<b>6</b>	Types of traffic permitted (IFR/VFR)	IFR/VFR
<b>7</b>	Remarks	Available for limited use subject to prior agreement of the Licensee. No operations permitted on Sundays except for medical emergencies.

**NCMR AD 2.3 OPERATIONAL HOURS**

<b>1</b>	AD Administration	0800–1600 Mon–Fri except public holidays
<b>2</b>	Customs and immigration	Nil
<b>3</b>	Health and sanitation	Hospital with limited facilities
<b>4</b>	AIS Briefing Office	Nil
<b>5</b>	ATS Reporting Office (ARO)	Nil
<b>6</b>	MET Briefing Office	Nil
<b>7</b>	ATS	Nil
<b>8</b>	Fuelling	Nil
<b>9</b>	Handling	During domestic flight hours for Air Rarotonga
<b>10</b>	Security	Nil
<b>11</b>	De-icing	Nil
<b>12</b>	Remarks	Nil

**NCMR AD 2.4 HANDLING SERVICES AND FACILITIES**

<b>1</b>	Cargo-handling facilities	Air Rarotonga
<b>2</b>	Fuel/oil types	Nil
<b>3</b>	Fuelling facilities/capabilities	Nil
<b>4</b>	De-icing facilities	Nil
<b>5</b>	Hangar space for visiting aircraft	Nil
<b>6</b>	Repair facilities for visiting aircraft	Nil
<b>7</b>	Remarks	Mitiaro is an unattended aerodrome

**NCMR AD 2.5 PASSENGER FACILITIES**

<b>1</b>	Hotels	Limited accommodation facilities
<b>2</b>	Restaurants	Nil
<b>3</b>	Transportation	Transfers or by prior arrangement
<b>4</b>	Medical facilities	Hospital
<b>5</b>	Bank and Post Office	In town
<b>6</b>	Tourist Office	Nil
<b>7</b>	Remarks	Nil

**NCMR AD 2.6 RESCUE AND FIRE FIGHTING SERVICES**

Nil

**NCMR AD 2.7 SEASONAL AVAILABILITY — CLEARING**

Nil

**NCMR AD 2.8 APRONS, TAXIWAYS AND CHECK LOCATIONS DATA**

<b>1</b>	Apron surface and strength	Compact coral
<b>2</b>	Taxiway width, surface and strength	Nil
<b>3</b>	ACL location and elevation	TBA TBA
<b>4</b>	VOR/INS checkpoints	Nil
<b>5</b>	Remarks	Nil

**NCMR AD 2.9 SURFACE MOVEMENT GUIDANCE,  
CONTROL SYSTEM AND MARKINGS**

Nil

**NCMR AD 2.10 AERODROME OBSTACLES**

In approach/TKOF areas			In circling area and at AD		Remarks
1			2		3
RWY/Area affected	Obstacle type Elevation Markings/ LGT	Coordinates	Obstacle type Elevation Markings/ LGT	Coordinates	
a	b	c	a	b	
09/27	TBA (1,b)	TBA (1,c)	TBA	TBA (2,b)	TBA
APRON	TBA (1,b)	TBA (1,c)	TBA	TBA (2,b)	

**NCMR AD 2.11 METEOROLOGICAL INFORMATION  
PROVIDED**

Nil

**NCMR AD 2.12 RWY PHYSICAL CHARACTERISTICS**

<b>RWY</b>	<b>TRUE BRG</b>	<b>Dimensions of RWY (m)</b>	<b>Strength (PCN) and surface of RWY and SWY</b>	<b>THR coordinates</b>	<b>THR elevation and highest elevation of TDZ of precision APP RWY</b>
<b>1</b>	<b>2</b>	<b>3</b>	<b>4</b>	<b>5</b>	<b>6</b>
09	106°	1200 x 30	ESWL 20420kg Coral	S 19 50 27.53 W 157 42 31.38	30ft
27	286°	1200 x 30	ESWL 20420kg Coral	S 19 50 39.22 W 157 41 52.02	33ft

<b>Slope of RWY-SWY</b>	<b>SWY dimensions (m)</b>	<b>CWY Dimensions (m)</b>	<b>Strip dimensions (m)</b>	<b>OFZ</b>	<b>Remarks</b>
<b>7</b>	<b>8</b>	<b>9</b>	<b>10</b>	<b>11</b>	<b>12</b>
			1500 x 90		
			1500 x 90		

**NCMR AD 2.13 DECLARED DISTANCES**

<b>RWY</b>	<b>TORA (m)</b>	<b>TODA (m)</b>	<b>ASDA (m)</b>	<b>LDA (m)</b>	<b>Remarks</b>
<b>1</b>	<b>2</b>	<b>3</b>	<b>4</b>	<b>5</b>	<b>6</b>
09	1200	1200	1200	1200	
27	1200	1200	1200	1200	

**NCMR AD 2.14 APPROACH AND RWY LIGHTING**

Nil

**NCMR AD 2.15 OTHER LIGHTING, SECONDARY POWER SUPPLY**

Nil

**NCMR AD 2.16 HELICOPTER LANDING AREA**

Nil

**NCMR AD 2.17 ATS AIRSPACE**

<b>1</b>	Designation and lateral limits	Nil
<b>2</b>	Vertical limits	Nil
<b>3</b>	Airspace classification	Nil
<b>4</b>	ATS unit callsign, language(s)	Nil
<b>5</b>	Transition altitude	13000ft
<b>6</b>	Remarks	Nil

**NCMR AD 2.18 ATS COMMUNICATIONS FACILITIES**

Nil

**NCMR AD 2.19 RADIO NAVIGATION AND LANDING AIDS**

Nil



## **NCMR AD 2.20 LOCAL TRAFFIC REGULATIONS**

### **1 AERODROME REGULATIONS**

1.1 Pilots are to maintain a continuous listening watch on the frequency listed in the COM box on the aerodrome chart, or on 118.1MHz if there is no such chart.

1.2 For the benefit of other traffic, pilots should broadcast their position, altitude and intentions as listed below:

- (a) In circuit: downwind when abeam the upwind end of the RWY.
- (b) Established on final to land.
- (c) In transit: between 5–10NM from the aerodrome.

1.3 Each aircraft transmission is to be preceded by the name of the aerodrome, "MITIARO TRAFFIC".

### **2 TAXIING TO AND FROM STANDS**

2.1 There are no taxiing stands or taxi routes. Taxi will be at the discretion of the pilot.

## **NCMR AD 2.21 NOISE ABATEMENT PROCEDURES**

There are no published noise abatement procedures for Mauke.

## NCMR AD 2.22 FLIGHT PROCEDURES

### 1 POSITION AND ALTITUDE REPORTING — LOCAL VFR FLIGHTS

1.1 Pilots of aircraft intending to operate under VFR from Mauke are required to report departure details after take-off on the nominated HF frequencies to Rarotonga "TOWER/FLIGHT SERVICE" if intending to proceed to other unattended aerodromes or when requesting clearance to enter Class C airspace.

1.2 When Rarotonga Flight Service is operating Rarotongs CTA Class C airspace reverts to Class G.

### 2 POSITION REPORTING ON DEPARTURE

2.1 Pilots are required to make a departure report as soon as practicable after take-off on the nominated HF frequencies to Rarotonga "TOWER/FLIGHT SERVICE" and must contain the following information:

- (a) Identification; radio callsign
- (b) Estimated set heading time in minutes past the hour
- (c) Phrase "CLIMBING TO" or "REQUEST" followed by altitude or flight level;
- (d) Next position and time over or ETA for destination

2.2 When Rarotonga Flight Service is operating Rarotongs CTA Class C airspace reverts to Class G.

### 3 AERODROME TRAFFIC CIRCUIT RULES

3.1 Circuit direction is:

- (a) RWY 09 is left-hand
- (b) RWY 27 is right-hand

## NCMR AD 2.23 ADDITIONAL INFORMATION

Nil

## NCMR AD 2.24 CHARTS RELATED TO AERODROME

- (a) Instrument Approach Charts  
MITIARO RNAV (GNSS) RWY 09 ..... NCMR AD 2-45.1
- (b) Aerodrome Charts  
MITIARO ..... NCMR AD 2-51.1



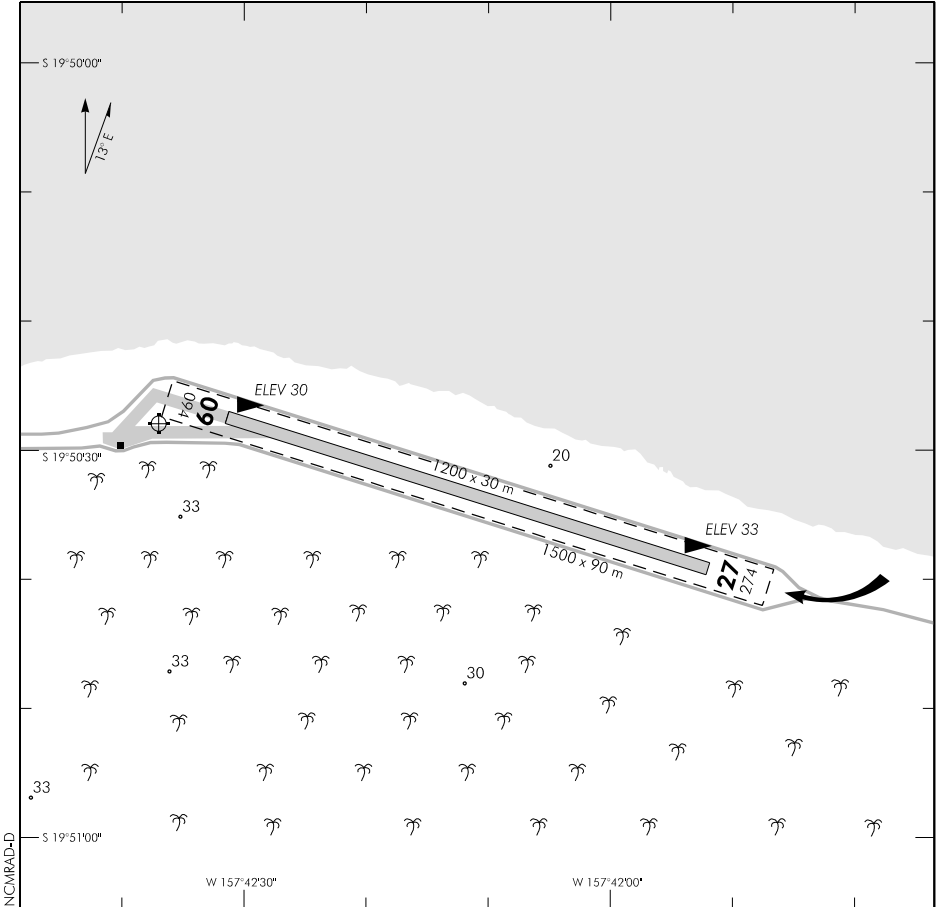
**Intentionally  
Blank**

ELEV 33

NCMR

# MITIARO AERODROME

UNATTENDED: 118.1



- 1. Circuit: RWY 09 – Left hand  
RWY 27 – Right hand

CIVIL IFR TAKE-OFF MINIMA			VFR MINIMA		
CEILING (ft) and VISIBILITY (m or km)			CEILING (ft) and VISIBILITY (m or km)		
RWY	DAY	NIGHT		DAY	NIGHT
09-27	NA	NA	AIR TRANSPORT	1000 – 5	NA
			ALL OTHER	600 – 1500	NA

**Effective: 25 MAY 17**

Changes from 23 JUL 15: Aerodrome elevations.

**Intentionally  
Blank**

## NCPY AD 2.1 AERODROME LOCATION INDICATOR AND NAME

NCPY	PENRHYN
------	---------

## NCPY AD 2.2 AERODROME GEOGRAPHICAL AND ADMINISTRATIVE DATA

<b>1</b>	ARP co-ordinates and site at AD	S09 00 21.78 W158 02 10.81 ARP site as depicted on NCPY AD 2-51.1
<b>2</b>	Direction and distance from city	APRX 3.5km SE from Omoka
<b>3</b>	Elevation/Reference temperature	11ft
<b>4</b>	MAG VAR/Annual change	11°E
<b>5</b>	AD Administration, address, telephone, telefax, telex, AFS	Penrhyn Island Council Omoka Island Secretary Phone 42100
<b>6</b>	Types of traffic permitted (IFR/VFR)	IFR/VFR
<b>7</b>	Remarks	Private flights subject to prior agreement of the Licensee. No operations permitted on Sundays except for medical emergencies

### NCPY AD 2.3 OPERATIONAL HOURS

<b>1</b>	AD Administration	0800–1600 Mon–Fri except public holidays
<b>2</b>	Customs and immigration	Nil
<b>3</b>	Health and sanitation	Hospital with limited facilities
<b>4</b>	AIS Briefing Office	Nil
<b>5</b>	ATS Reporting Office (ARO)	Nil
<b>6</b>	MET Briefing Office	Nil
<b>7</b>	ATS	Nil
<b>8</b>	Fuelling	Nil
<b>9</b>	Handling	By prior arrangement through Air Rarotonga
<b>10</b>	Security	Nil
<b>11</b>	De-icing	Nil
<b>12</b>	Remarks	Nil

### NCPY AD 2.4 HANDLING SERVICES AND FACILITIES

<b>1</b>	Cargo-handling facilities	By prior arrangement through Air Rarotonga
<b>2</b>	Fuel/oil types	Nil
<b>3</b>	Fuelling facilities/capabilities	Nil
<b>4</b>	De-icing facilities	Nil
<b>5</b>	Hangar space for visiting aircraft	Nil
<b>6</b>	Repair facilities for visiting aircraft	Nil
<b>7</b>	Remarks	Nil



**NCPY AD 2.5 PASSENGER FACILITIES**

<b>1</b>	Hotels	Nil
<b>2</b>	Restaurants	Nil
<b>3</b>	Transportation	Nil
<b>4</b>	Medical facilities	Hospital
<b>5</b>	Bank and Post Office	Nil
<b>6</b>	Tourist Office	Nil
<b>7</b>	Remarks	Nil

**NCPY AD 2.6 RESCUE AND FIRE FIGHTING SERVICES**

Nil

**NCPY AD 2.7 SEASONAL AVAILABILITY — CLEARING**

Nil

**NCPY AD 2.8 APRONS, TAXIWAYS AND CHECK LOCATIONS DATA**

<b>1</b>	Apron surface and strength	TBA
<b>2</b>	Taxiway width, surface and strength	Nil
<b>3</b>	ACL location and elevation	RWY 14 8ft RWY 32 8ft
<b>4</b>	VOR/INS checkpoints	Nil
<b>5</b>	Remarks	Nil

## NCPY AD 2.9 SURFACE MOVEMENT GUIDANCE, CONTROL SYSTEM AND MARKINGS

Nil

## NCPY AD 2.10 AERODROME OBSTACLES

In approach/TKOF areas			In circling area and at AD		Remarks
1			2		3
RWY/Area affected	Obstacle type Elevation Markings/ LGT	Coordinates	Obstacle type Elevation Markings/ LGT	Coordinates	
a	b	c	a	b	
14/32	TBA (1,b)	TBA (1,c)	TBA	TBA (2,b)	TBA
APRON	TBA (1,b)	TBA (1,c)	TBA	TBA (2,b)	

## NCPY AD 2.11 METEOROLOGICAL INFORMATION PROVIDED

Nil

**NCPY AD 2.12 RWY PHYSICAL CHARACTERISTICS**

<b>RWY</b>	<b>TRUE BRG</b>	<b>Dimensions of RWY (m)</b>	<b>Strength (PCN) and surface of RWY and SWY</b>	<b>THR coordinates</b>	<b>THR elevation and highest elevation of TDZ of precision APP RWY</b>
<b>1</b>	<b>2</b>	<b>3</b>	<b>4</b>	<b>5</b>	<b>6</b>
14	152°	2157 x 30	ESWL 20420kg Coral	S 09 00 23.01 W 158 02 11.42	11ft
32	332°	2157 x 30	ESWL 20420kg Coral	S 09 01 25.03 W 158 01 38.30	10ft

<b>Slope of RWY-SWY</b>	<b>SWY dimensions (m)</b>	<b>CWY Dimensions (m)</b>	<b>Strip dimensions (m)</b>	<b>OFZ</b>	<b>Remarks</b>
<b>7</b>	<b>8</b>	<b>9</b>	<b>10</b>	<b>11</b>	<b>12</b>
			2295 x 90		
			2295 x 90		

**NCPY AD 2.13 DECLARED DISTANCES**

<b>RWY</b>	<b>TORA (m)</b>	<b>TODA (m)</b>	<b>ASDA (m)</b>	<b>LDA (m)</b>	<b>Remarks</b>
<b>1</b>	<b>2</b>	<b>3</b>	<b>4</b>	<b>5</b>	<b>6</b>
14	2157	2157	2157	2157	
32	2157	2157	2157	2157	

**NCPY AD 2.14 APPROACH AND RWY LIGHTING**

Nil

**NCPY AD 2.15 OTHER LIGHTING, SECONDARY POWER SUPPLY**

Nil

**NCPY AD 2.16 HELICOPTER LANDING AREA**

Nil

**NCPY AD 2.17 ATS AIRSPACE**

<b>1</b>	Designation and lateral limits	Nil
<b>2</b>	Vertical limits	Nil
<b>3</b>	Airspace classification	Nil
<b>4</b>	ATS unit callsign, language(s)	Nil
<b>5</b>	Transition altitude	13000ft
<b>6</b>	Remarks	Nil

**NCPY AD 2.18 ATS COMMUNICATIONS FACILITIES**

Nil

## NCPY AD 2.19 RADIO NAVIGATION AND LANDING AIDS

Type of Aid	Ident	Freq	Hours of Operation	Coordinates	NDB Elevation	Remarks
1	2	3	4	5	6	7
NDB	PY	400	O/R	S 08 59 38.99 W 158 02 37.83	82ft	TBA

## NCPY AD 2.20 LOCAL TRAFFIC REGULATIONS

### 1 AERODROME REGULATIONS

1.1 Pilots are to maintain a continuous listening watch on the frequency listed in the COM box on the aerodrome chart, or on 118.1MHz if there is no such chart.

1.2 For the benefit of other traffic, pilots should broadcast their position, altitude and intentions as listed below:

- (a) Inbound
- (i) overhead the radio aid serving the aerodrome, or commencing instrument approach; and
  - (ii) when established on final approach; and
  - (iii) at the termination of the instrument approach, i.e. when breaking off from the procedure to proceed in VMC to the aerodrome; and
  - (iv) immediately before joining the traffic circuit.
- (b) In circuit: downwind when abeam the upwind end of the RWY.
- (c) In transit: between 5–10NM from the aerodrome.

1.3 Each aircraft transmission is to be preceded by the name of the aerodrome, "PENRHYN TRAFFIC".

### 2 TAXIING TO AND FROM STANDS

2.1 There are no taxiing stands or taxi routes. Taxi will be at the discretion of the pilot.

## NCPY AD 2.21 NOISE ABATEMENT PROCEDURES

There are no published noise abatement procedures for Penrhyn.

## NCPY AD 2.22 FLIGHT PROCEDURES

### 1 POSITION AND ALTITUDE REPORTING — LOCAL VFR FLIGHTS

1.1 Pilots of aircraft intending to operate under VFR from Penrhyn are required to report departure details after take-off on the nominated HF frequencies to Rarotonga "TOWER/FLIGHT SERVICE" if intending to proceed to other unattended aerodromes.

### 2 POSITION REPORTING ON DEPARTURE

2.1 Pilots are required to make a departure report as soon as practicable after take-off on the nominated HF frequencies to Rarotonga "TOWER/FLIGHT SERVICE" and must contain the following information:

- (a) Identification; radio callsign
- (b) Estimated set heading time in minutes past the hour
- (c) Phrase "CLIMBING TO" or "REQUEST" followed by altitude or flight level;
- (d) Next position and time over or ETA for destination

### 3 AERODROME TRAFFIC CIRCUIT RULES

3.1 Circuit direction is:

- (a) RWY 14 is left-hand
- (b) RWY 32 is right-hand

## NCPY AD 2.23 ADDITIONAL INFORMATION

Nil

## NCPY AD 2.24 CHARTS RELATED TO AERODROME

- (a) Instrument Approach Charts
  - PENRHYN NDB RWY 14 ..... NCPY AD 2-44.1
  - PENRHYN RNAV (GNSS) RWY 32 ..... NCPY AD 2-45.1
- (b) Aerodrome Charts
  - PENRHYN ..... NCPY AD 2-51.1

ELEV 11

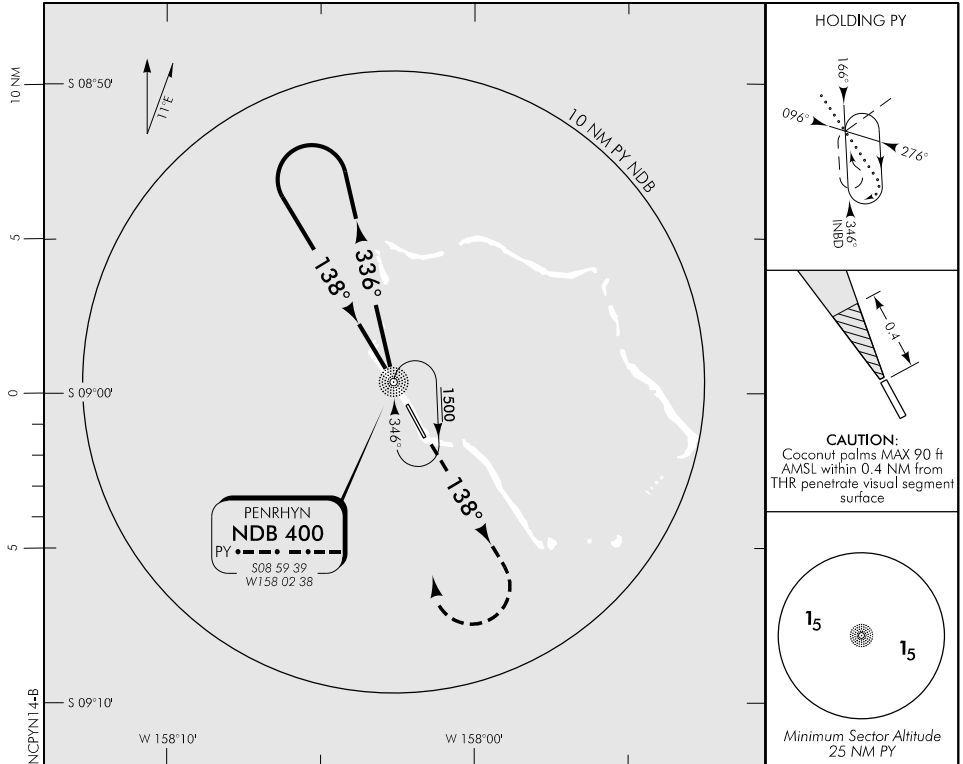
CAT A,B

**PENRHYN**

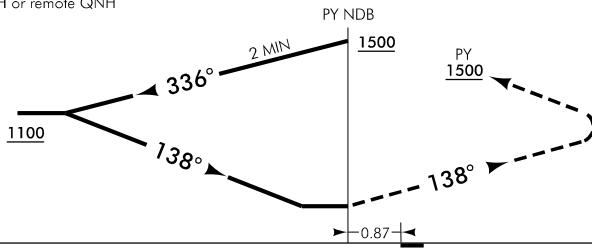
RWY 14 THR ELEV 11

**NDB RWY 14**

UNATTENDED: 118.1



Use Penrhyn QNH or remote QNH



**MISSED APCH:** Climb on track 138°, turn RIGHT enter PY holding 1500, advise intentions

Category	A	B	C	D
NDB *	420(409) – 1600			NA
Circling	450(439) – 1900	510(499) – 2800		NA

\* Non-compliant with ICAO PANS-OPS straight-in criteria. VSS penetrated – See caution note.

Changes from 15 DEC 11: Mirima, CAT C removed, AD and THR ELEV, minor track changes, QNH source, PY holding tracks.

**Effective: 6 DEC 18**

**Intentionally  
Blank**



ELEV 11

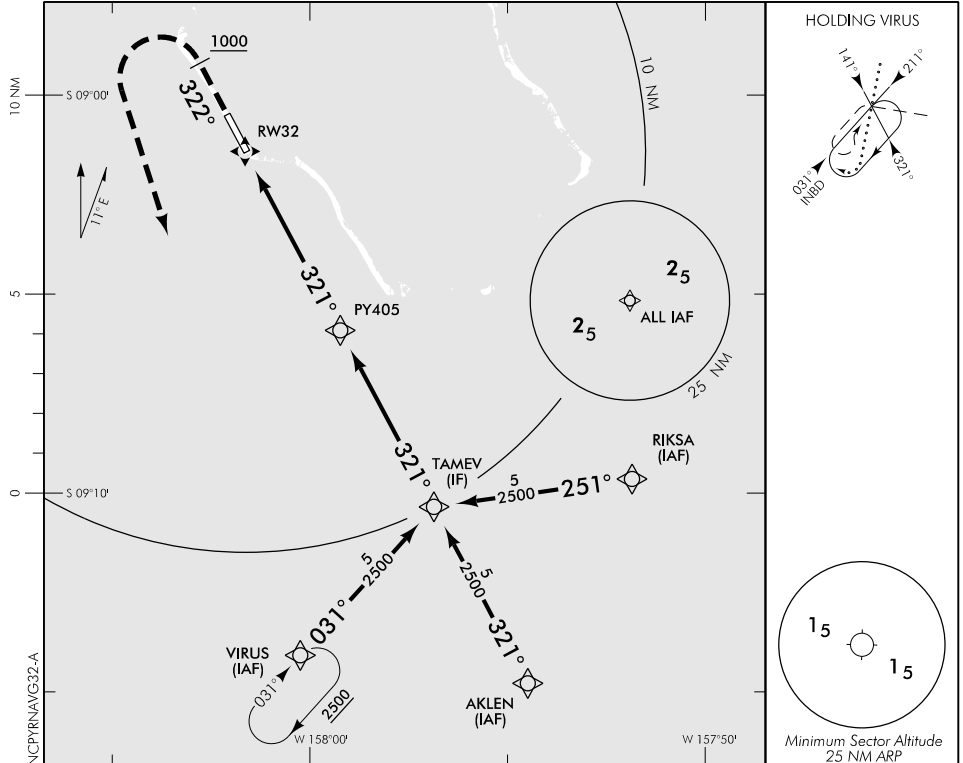
CAT A,B

**PENRHYN**

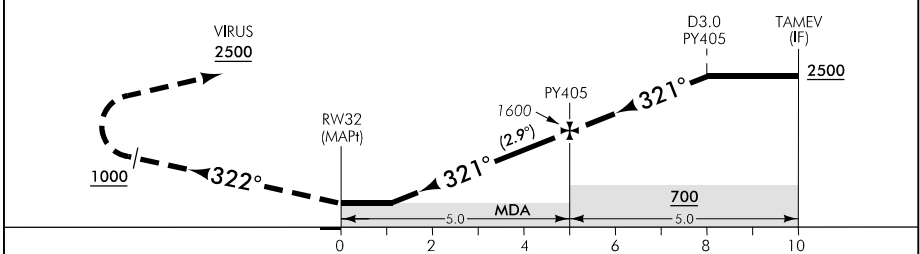
RWY 32 THR ELEV 10

**RNAV (GNSS) RWY 32**

UNATTENDED: 118.1



Use Penrhyn QNH or remote QNH



**MISSED APCH:** Track 322° to 1000, turn LEFT direct to VIRUS 2500

DISTANCE TO WPT	RW32	1.1	2	3	4	PY405	1	2	3	4	5
Advisory Altitude 5%	MDA	MDA	700	1000	1300	1600	1900	2200	2500	2800	3100
Category	A		B			C			D		
LNAV	400(389) – 1600						NA				
Circling	450(439) – 1900			510(499) – 2800			NA				

**Effective: 6 DEC 18**

New chart.

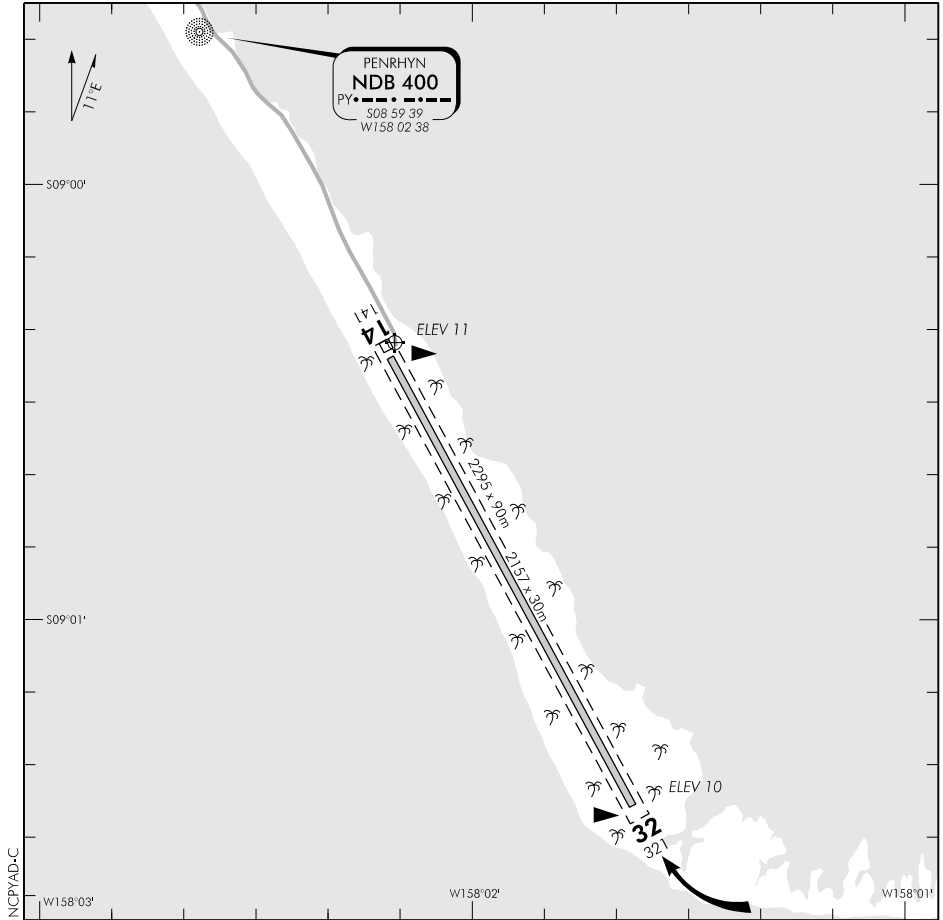
**Intentionally  
Blank**

ELEV 11

NCPY

**PENRHYN  
AERODROME**

UNATTENDED: 118.1



1. Circuit: RWY 14 – Left hand  
RWY 32 – Right hand
2. Landing thresholds unmarked.
3. CAUTION: Palms and bushes on approaches and around strip.

CIVIL IFR TAKE-OFF MINIMA			VFR MINIMA		
CEILING (ft) and VISIBILITY (m or km)			CEILING (ft) and VISIBILITY (m or km)		
RWY	DAY	NIGHT		DAY	NIGHT
14-32	400 – 2000	NA	AIR TRANSPORT	1000 – 5000	NA
			ALL OTHER	600 – 1500	NA

**Effective: 6 DEC 18**

S 09 00 22 W 158 02 11

© Government of Cook Islands

**PENRHYN  
AERODROME**

**Intentionally  
Blank**

## NCPK AD 2.1 AERODROME LOCATION INDICATOR AND NAME

NCPK	PUKAPUKA
------	----------

## NCPK AD 2.2 AERODROME GEOGRAPHICAL AND ADMINISTRATIVE DATA

<b>1</b>	ARP co-ordinates and site at AD	S 10 54 47.84 W 165 49 59.02 ARP site as depicted on NCPK AD 2-51.1
<b>2</b>	Direction and distance from city	7km south of main township
<b>3</b>	Elevation/Reference temperature	18ft
<b>4</b>	MAG VAR/Annual change	11°E
<b>5</b>	AD Administration, address, telephone, telefax, telex, AFS	Pukapuka Island Council Pukapuka COOK ISLANDS Tel: 41 044 (Govt Rep)
<b>6</b>	Types of traffic permitted (IFR/VFR)	IFR/VFR
<b>7</b>	Remarks	Private flights subject to prior agreement of the Licensee. No operations permitted on Sundays except for medical emergencies.

**NCPK AD 2.3 OPERATIONAL HOURS**

<b>1</b>	AD Administration	0800–1600 Mon–Fri except public holidays
<b>2</b>	Customs and immigration	NA
<b>3</b>	Health and sanitation	Hospital with limited facilities
<b>4</b>	AIS Briefing Office	Nil
<b>5</b>	ATS Reporting Office (ARO)	Nil
<b>6</b>	MET Briefing Office	Nil
<b>7</b>	ATS	Nil
<b>8</b>	Fuelling	Nil
<b>9</b>	Handling	Nil
<b>10</b>	Security	Nil
<b>11</b>	De-icing	Nil
<b>12</b>	Remarks	Nil

**NCPK AD 2.4 HANDLING SERVICES AND FACILITIES**

<b>1</b>	Cargo-handling facilities	Nil
<b>2</b>	Fuel/oil types	Nil
<b>3</b>	Fuelling facilities/capabilities	Nil
<b>4</b>	De-icing facilities	Nil
<b>5</b>	Hangar space for visiting aircraft	Nil
<b>6</b>	Repair facilities for visiting aircraft	Nil
<b>7</b>	Remarks	Pukapuka is an unattended aerodrome

**NCPK AD 2.5 PASSENGER FACILITIES**

<b>1</b>	Hotels	Nil
<b>2</b>	Restaurants	Nil
<b>3</b>	Transportation	Nil
<b>4</b>	Medical facilities	Nil
<b>5</b>	Bank and Post Office	Nil
<b>6</b>	Tourist Office	Nil
<b>7</b>	Remarks	Nil

**NCPK AD 2.6 RESCUE AND FIRE FIGHTING SERVICES**

Nil

**NCPK AD 2.7 SEASONAL AVAILABILITY — CLEARING**

Nil

**NCPK AD 2.8 APRONS, TAXIWAYS AND CHECK LOCATIONS DATA**

<b>1</b>	Apron surface and strength	TBA
<b>2</b>	Taxiway width, surface and strength	Nil
<b>3</b>	ACL location and elevation	RWY 07 15ft RWY 25 15ft
<b>4</b>	VOR/INS checkpoints	Nil
<b>5</b>	Remarks	Nil

## NCPK AD 2.9 SURFACE MOVEMENT GUIDANCE, CONTROL SYSTEM AND MARKINGS

Nil

## NCPK AD 2.10 AERODROME OBSTACLES

In approach/TKOF areas			In circling area and at AD		Remarks
1			2		3
RWY/Area affected	Obstacle type Elevation Markings/ LGT	Coordinates	Obstacle type Elevation Markings/ LGT	Coordinates	
a	b	c	a	b	
07/25	TBA (1,b)	TBA (1,c)	TBA	TBA (2,b)	TBA
APRON	TBA (1,b)	TBA (1,c)	TBA	TBA (2,b)	

## NCPK AD 2.11 METEOROLOGICAL INFORMATION PROVIDED

Nil



**NCPK AD 2.12 RWY PHYSICAL CHARACTERISTICS**

<b>RWY</b>	<b>TRUE BRG</b>	<b>Dimensions of RWY (m)</b>	<b>Strength (PCN) and surface of RWY and SWY</b>	<b>THR coordinates</b>	<b>THR elevation and highest elevation of TDZ of precision APP RWY</b>
<b>1</b>	<b>2</b>	<b>3</b>	<b>4</b>	<b>5</b>	<b>6</b>
07	084°	1385 x 30	ESWL 20420kg Coral	S 10 54 54.53 W 165 50 44.49	18ft
25	264°	1385 x 30	ESWL 20420kg Coral	S 10 54 49.62 W 165 49 59.15	17ft

<b>Slope of RWY-SWY</b>	<b>SWY dimensions (m)</b>	<b>CWY Dimensions (m)</b>	<b>Strip dimensions (m)</b>	<b>OFZ</b>	<b>Remarks</b>
<b>7</b>	<b>8</b>	<b>9</b>	<b>10</b>	<b>11</b>	<b>12</b>
			1505 x 90		
			1505 x 90		

**NCPK AD 2.13 DECLARED DISTANCES**

<b>RWY</b>	<b>TORA (m)</b>	<b>TODA (m)</b>	<b>ASDA (m)</b>	<b>LDA (m)</b>	<b>Remarks</b>
<b>1</b>	<b>2</b>	<b>3</b>	<b>4</b>	<b>5</b>	<b>6</b>
07	1385	1385	1385	1385	
25	1385	1385	1385	1385	

**NCPK AD 2.14 APPROACH AND RWY LIGHTING**

Nil

**NCPK AD 2.15 OTHER LIGHTING, SECONDARY POWER SUPPLY**

Nil

**NCPK AD 2.16 HELICOPTER LANDING AREA**

Nil

**NCPK AD 2.17 ATS AIRSPACE**

<b>1</b>	Designation and lateral limits	Nil
<b>2</b>	Vertical limits	Nil
<b>3</b>	Airspace classification	Nil
<b>4</b>	ATS unit callsign, language(s)	Nil
<b>5</b>	Transition altitude	13000ft
<b>6</b>	Remarks	Nil

**NCPK AD 2.18 ATS COMMUNICATIONS FACILITIES**

Nil

## **NCPK AD 2.19 RADIO NAVIGATION AND LANDING AIDS**

Nil

## **NCPK AD 2.20 LOCAL TRAFFIC REGULATIONS**

### **1 AERODROME REGULATIONS**

1.1 Pilots are to maintain a continuous listening watch on the frequency listed in the COM box on the aerodrome chart, or on 118.1MHz if there is no such chart.

1.2 For the benefit of other traffic, pilots should broadcast their position, altitude and intentions as listed below:

- (a) In circuit: downwind when abeam the upwind end of the RWY.
- (b) Established on finals to land
- (c) In transit: between 5–10NM from the aerodrome.

1.3 Each aircraft transmission is to be preceded by the name of the aerodrome, "PUKAPUKA TRAFFIC".

### **2 TAXIING TO AND FROM STANDS**

2.1 There are no taxiing stands or taxi routes. Taxi will be at the discretion of the pilot.

## **NCPK AD 2.21 NOISE ABATEMENT PROCEDURES**

There are no published noise abatement procedures for Penrhyn.

## NCPK AD 2.22 FLIGHT PROCEDURES

### 1 POSITION AND ALTITUDE REPORTING — LOCAL VFR FLIGHTS

1.1 Pilots of aircraft intending to operate under VFR from Pukapuka are required to report departure details after take-off on the nominated HF frequencies to Rarotonga "TOWER/FLIGHT SERVICE" if intending to proceed to other unattended aerodromes.

### 2 POSITION REPORTING ON DEPARTURE

2.1 Pilots are required to make a departure report as soon as practicable after take-off on the nominated HF frequencies to Rarotonga "TOWER/FLIGHT SERVICE" and must contain the following information:

- (a) Identification; radio callsign
- (b) Estimated set heading time in minutes past the hour
- (c) Phrase "CLIMBING TO" followed by altitude or flight level;
- (d) Next position and time over or ETA for destination

### 3 AERODROME TRAFFIC CIRCUIT RULES

3.1 Circuit direction is:

- (a) RWY 07 is left-hand
- (b) RWY 25 is right-hand

## NCPK AD 2.23 ADDITIONAL INFORMATION

Nil

## NCPK AD 2.24 CHARTS RELATED TO AERODROME

- (a) Instrument Approach Charts  
 PUKAPUKA RNAV (GNSS) RWY 25 ..... NCPK AD 2-45.1
- (b) Aerodrome Charts  
 PUKAPUKA ..... NCPK AD 2-51.1

ELEV 18

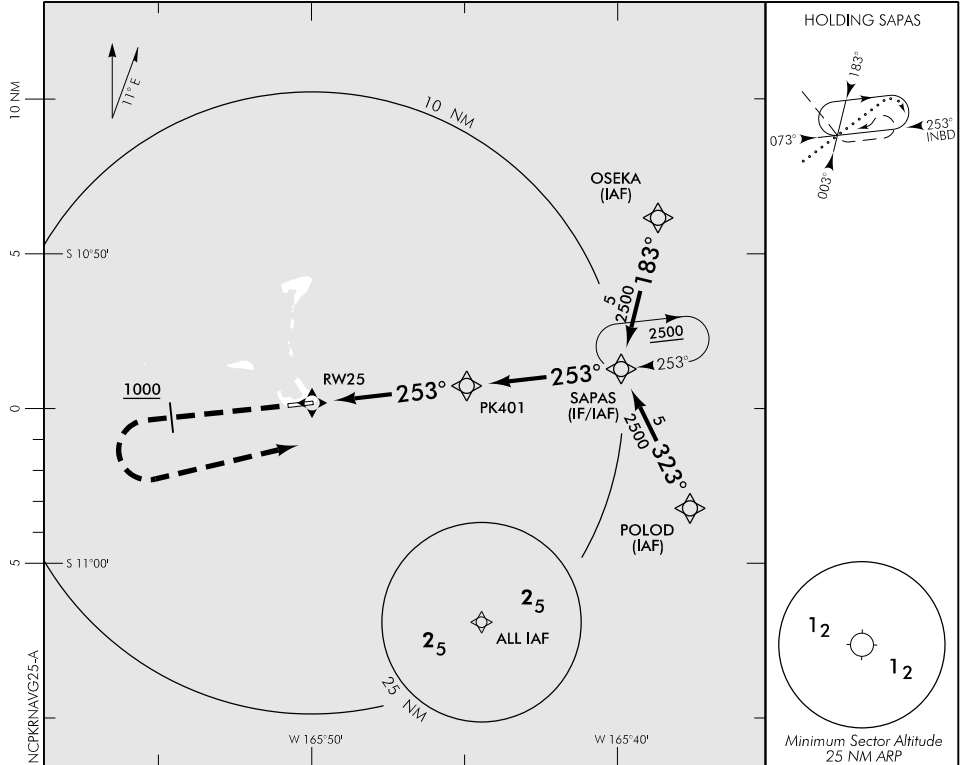
CAT A,B

# PUKAPUKA

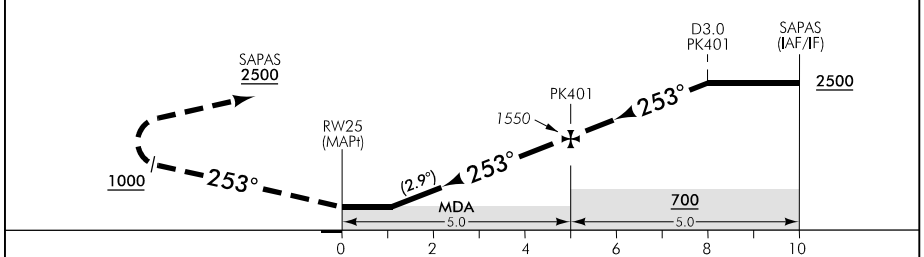
RWY 25 THR ELEV 17

**RNAV (GNSS) RWY 25**

UNATTENDED: 118.1



Use Pukapuka QNH or remote QNH



**MISSED APCH:** Track 253° to 1000, turn LEFT direct to SAPAS 2500

DISTANCE to WPT	RWY25	1.1	2	3	4	PK401	1	2	3	4	SAPAS
Advisory Altitude 5%	MDA	MDA	650	950	1250	1550	1850	2150	2450	2750	3050
Category	A		B			C			D		
LNAV	400(382) – 1600						NA				
Circling	450(432) – 1900			510(492) – 2800			NA				

**Effective: 6 DEC 18**

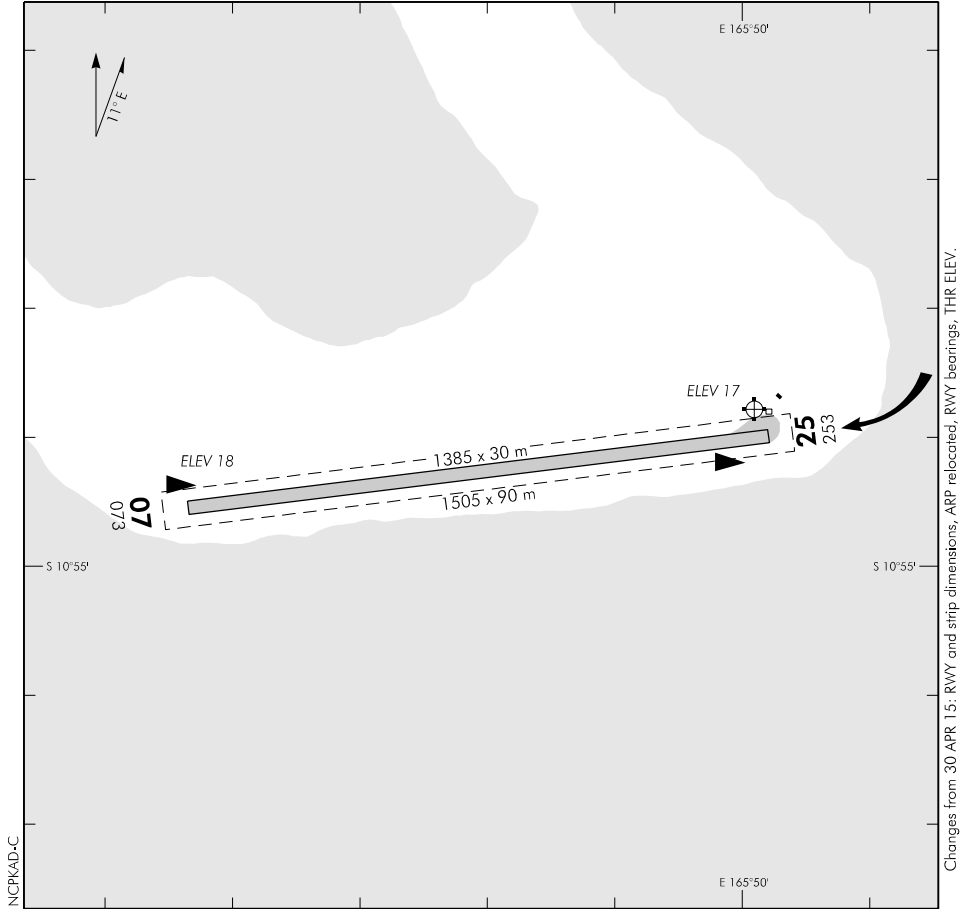
**Intentionally  
Blank**

ELEV 18

NCPK

**PUKAPUKA  
AERODROME**

UNATTENDED: 118.1



1. Circuit: RWY 07 – Left hand  
RWY 25 – Right hand

CIVIL IFR TAKE-OFF MINIMA			VFR MINIMA		
CEILING (ft) and VISIBILITY (m or km)			CEILING (ft) and VISIBILITY (m or km)		
RWY	DAY	NIGHT		DAY	NIGHT
07	500 – 2000	NA	AIR TRANSPORT	1000 – 5	NA
25	500 – 2000	NA	ALL OTHER	600 – 1500	NA

**Effective: 6 DEC 18**

**Intentionally  
Blank**



## NCRG AD 2.1 AERODROME LOCATION INDICATOR AND NAME

NCRG	RAROTONGA
------	-----------

## NCRG AD 2.2 AERODROME GEOGRAPHICAL AND ADMINISTRATIVE DATA

<b>1</b>	ARP co-ordinates and site at AD	S 21 12 04.52 W 159 47 56.56 ARP site as depicted on NCRG AD 2-51.1
<b>2</b>	Direction and distance from city	1.75NM W of Avarua township
<b>3</b>	Elevation/Reference temperature	19ft/29.1°C (February)
<b>4</b>	MAG VAR/Annual change	13° 54' E (2016)
<b>5</b>	AD Administration, address, telephone, telefax, telex, AFS	Chief Executive Cook Islands Airport Authority PO Box 90 Rarotonga COOK ISLANDS  Fax: (682) 21 890 AFTN: NCRGYDYX email: jngamata@airport.gov.ck
<b>6</b>	Types of traffic permitted (IFR/VFR)	IFR/VFR
<b>7</b>	Remarks	Except in an emergency, Rarotonga International Airport is closed on Sundays between 0930–1200 LT in respect of church services.

**NCRG AD 2.3 OPERATIONAL HOURS**

<b>1</b>	AD Administration	0800–1600 Mon–Fri except public holidays
<b>2</b>	Customs and immigration	0800–1600 Mon–Fri and during scheduled international flights
<b>3</b>	Health and sanitation	H24
<b>4</b>	AIS Briefing Office	As per notamed hours of watch for ATC/FS
<b>5</b>	ATS Reporting Office (ARO)	As per notamed hours of watch for ATC/FS
<b>6</b>	MET Briefing Office	H24
<b>7</b>	ATS	As per notamed hours of watch for ATC/FS
<b>8</b>	Fuelling	Mon–Sat 0800–1600 and by arrangement
<b>9</b>	Handling	<p>Air New Zealand  Tel: +682 26300 or +682 71321  Email: <a href="mailto:fanny.utanga@airnz.co.nz">fanny.utanga@airnz.co.nz</a> or  <a href="mailto:marisa.newman@airnz.co.nz">marisa.newman@airnz.co.nz</a> or  <a href="mailto:paul.turepu@airnz.co.nz">paul.turepu@airnz.co.nz</a></p> <p>Air Rarotonga  Tel: +682 20845 or +682 56408  Email: <a href="mailto:checkin@airraro.co.ck">checkin@airraro.co.ck</a> or  <a href="mailto:ross.warwick@airraro.com">ross.warwick@airraro.com</a></p>
<b>10</b>	Security	For all scheduled domestic and international ops and private charters
<b>11</b>	De-icing	Nil
<b>12</b>	Remarks	LT is UTC minus 10 hours

**NCRG AD 2.4 HANDLING SERVICES AND FACILITIES**

<b>1</b>	Cargo-handling facilities	Air New Zealand for international operations or Air Rarotonga for domestic operations
<b>2</b>	Fuel/oil types	Jet A1
<b>3</b>	Fuelling facilities/capabilities	By arrangement
<b>4</b>	De-icing facilities	Nil
<b>5</b>	Hangar space for visiting aircraft	Nil
<b>6</b>	Repair facilities for visiting aircraft	Nil
<b>7</b>	Remarks	Nil

**NCRG AD 2.5 PASSENGER FACILITIES**

<b>1</b>	Hotels	Hotel/backpacker accommodation near airport; unlimited around the island
<b>2</b>	Restaurants	Situated around the island
<b>3</b>	Transportation	Taxis, transfers, rental cars, buses
<b>4</b>	Medical facilities	First Aid at airport. Hospital 3km W of airport
<b>5</b>	Bank and Post Office	ATM machine available in Arrival Terminal
<b>6</b>	Tourist Office	In town and 300m W of airport entrance
<b>7</b>	Remarks	Nil

**NCRG AD 2.6 RESCUE AND FIRE FIGHTING SERVICES**

<b>1</b>	AD category for fire fighting	Category 8
<b>2</b>	Rescue equipment	Four RFS appliances, one marine rescue boat, medical equipment, standby generator, stretchers, portable lights, portable pump trailer, boat trailer
<b>3</b>	Capability for removal of disabled aircraft	For aircraft up to 21000kg — improvised equipment available locally  For aircraft up to 21000–150 000kg — salvage kit ex Auckland  For aircraft above 150 000kg — IATA kit ex Sydney, Honolulu or Los Angeles
<b>4</b>	Remarks	Nil

**NCRG AD 2.7 SEASONAL AVAILABILITY — CLEARING**

<b>1</b>	Types of clearing equipment	Not available
<b>2</b>	Clearance priorities	
<b>3</b>	Remarks	

**NCRG AD 2.8 APRONS, TAXIWAYS AND CHECK LOCATIONS DATA**

<b>1</b>	Apron surface and strength	Concrete PCN 54/R/B/W/T
<b>2</b>	Taxiway width, surface and strength	Width: 33m Surface: Concrete Strength: PCN 54/R/B/W/T
<b>3</b>	ACL location and elevation	RWY 08 threshold 19ft RWY 26 threshold 14ft
<b>4</b>	VOR/INS checkpoints	Nil
<b>5</b>	Remarks	Nil

## NCRG AD 2.9 SURFACE MOVEMENT GUIDANCE, CONTROL SYSTEM AND MARKINGS

<b>1</b>	Use of aircraft stand ID signs, TWY guide lines and visual docking/parking guidance system of aircraft stands	TBA
<b>2</b>	RWY and TWY markings and LGT	RWY: Designation, threshold and wingbars, centreline, RWY edge and Runway End Identification Lights (REILS)
<b>3</b>	Stop bars	TBA
<b>4</b>	Remarks	Nil

## NCRG AD 2.10 AERODROME OBSTACLES

In approach/TKOF areas			In circling area and at AD		Remarks
1			2		
RWY/Area affected	Obstacle type Elevation Markings/ LGT	Coordinates	Obstacle type Elevation Markings/ LGT	Coordinates	TBA
a	b	c	a	b	
08/26	TBA (1,b)	TBA (1,c)	TBA	TBA (2,b)	
APRON	TBA (1,b)	TBA (1,c)	TBA	TBA (2,b)	

## NCRG AD 2.11 METEOROLOGICAL INFORMATION PROVIDED

<b>1</b>	Associated MET Office	Nadi Meteorological Office
<b>2</b>	Hours of service MET Office	H24
<b>3</b>	Office responsible for TAF preparation Periods of validity	Nadi Meteorological Office and Kelburn Meteorological Office
<b>4</b>	Type of landing forecast Interval of issuance	TBA
<b>5</b>	Briefing/consultation provided	TBA
<b>6</b>	Flight documentation Language(s) used	English
<b>7</b>	Charts and other information available for briefing or consultation	TBA
<b>8</b>	Supplementary equipment available for providing information	TBA
<b>9</b>	ATS units provided with information	TBA
<b>10</b>	Additional information (limitation of service, etc)	Nil

**NCRG AD 2.12 RWY PHYSICAL CHARACTERISTICS**

<b>RWY</b>	<b>TRUE BRG</b>	<b>Dimensions of RWY (m)</b>	<b>Strength (PCN) and surface of RWY and SWY</b>	<b>THR coordinates</b>	<b>THR elevation and highest elevation of TDZ of precision APP RWY</b>
<b>1</b>	<b>2</b>	<b>3</b>	<b>4</b>	<b>5</b>	<b>6</b>
08	090°	2329 x 45	PCN 54/R/B/W/T Concrete	S 21 12 09.30 W 159 48 56.55	19ft
26	270°	2329 x 45	PCN 54/R/B/W/T Concrete	S 21 12 09.31 W 159 47 43.61	14ft

<b>Slope of RWY-SWY</b>	<b>SWY dimensions (m)</b>	<b>CWY Dimensions (m)</b>	<b>Strip dimensions (m)</b>	<b>OFZ</b>	<b>Remarks</b>
<b>7</b>	<b>8</b>	<b>9</b>	<b>10</b>	<b>11</b>	<b>12</b>
0.07D			2368 x 213		
0.07U			2368 x 213		

**NCRG AD 2.13 DECLARED DISTANCES**

<b>RWY</b>	<b>TORA (m)</b>	<b>TODA (m)</b>	<b>ASDA (m)</b>	<b>LDA (m)</b>	<b>Remarks</b>
<b>1</b>	<b>2</b>	<b>3</b>	<b>4</b>	<b>5</b>	<b>6</b>
08	2329	2348	2329	2207	
26	2329	2348	2329	2225	

**NCRG AD 2.14 APPROACH AND RWY LIGHTING**

<b>RWY</b>	<b>APCH LGT Type LEN INTST</b>	<b>THR LGT Colour WBAR</b>	<b>VASIS (MEH) PAPI</b>	<b>TDZ LGT LEN</b>	<b>RWY Centre Line LGT LEN Spacing Colour, INTST</b>	<b>RWY Edge LGT LEN Spacing Colour, INTST</b>	<b>RWY End LGT Colour WBAR</b>	<b>SWY LGT LEN (m) Colour</b>	<b>Remarks</b>
<b>08</b>	Nil	LIH uni- directional green	PAPI* 3° TCH 69ft	Nil	LIH coded white/red	Omni- directional LIH white	LIH uni- directional red	Nil	Nil
<b>26</b>	Nil	LIH uni- directional green	PAPI* 3° TCH 68.7ft	Nil	LIH coded white/red	Omni- directional LIH white	LIH uni- directional red	Nil	Nil

\*Note: Both PAPIs are double-sided



## NCRG AD 2.15 OTHER LIGHTING, SECONDARY POWER SUPPLY

<b>1</b>	ABN/IBN location, characteristics and hours of operation	ABN FLG W 3.75sec
<b>2</b>	LDI location and LGT, Anemometer location and LGT	TBA
<b>3</b>	TWY edge and centreline lighting	TBA
<b>4</b>	Secondary power supply/switch-over time	Available/15 seconds
<b>5</b>	Remarks	TBA

## NCRG AD 2.16 HELICOPTER LANDING AREA

<b>1</b>	Co-ordinates of TLOF or THR of FATO	TBA
<b>2</b>	TLOF and/or FATO elevation (ft)	TBA
<b>3</b>	TLOF and FATO area dimensions, surface, strength and markings	TBA
<b>4</b>	True and MAG BRG of FATO	TBA
<b>5</b>	Declared distance available	TBA
<b>6</b>	APP and FATO lighting	TBA
<b>7</b>	Remarks	TBA

**NCRG AD 2.17 ATS AIRSPACE**

<b>1</b>	Designation and lateral limits	<p><b>CTR</b> Radius of 30NM centred on NCRG VOR/DME</p> <p><b>CTA</b> Radius of 50NM centred on NCRG VOR/DME Radius of 70NM centred on NCRG VOR/DME Line from 20S 157W to 21 41S 157W intersecting tangent of circle 100NM radius centred on RG VOR/DME continuing around arc north to intersect next tangent of a circle of 100NM centred on NCAI NDB back to 20S 157W</p> <p><b>Within the Cook Sector</b> Outside lateral limits of NCRG CTA, airspace is Class G</p>
<b>2</b>	Vertical limits	<p>CTR SFC – 5500ft CTA 5500 – 9500ft 9500ft – FL145 FL145 – FL245</p>
<b>3</b>	Airspace classification	<p>Class D at or below 5500ft Class C above 5500ft to FL245 During the hours that FS is operating on watch, Class C and Class D becomes Class G airspace</p>
<b>4</b>	ATS unit callsign, language(s)	<p>Rarotonga TWR, during HR ATC is operating</p> <p>Rarotonga FS, during HR FS is operating</p> <p>English</p>
<b>5</b>	Transition altitude	13000ft
<b>6</b>	Remarks	

**NCRG AD 2.18 ATS COMMUNICATIONS FACILITIES**

<b>Service Designation</b>	<b>Callsign</b>	<b>Frequency</b>	<b>Hours of Operation</b>	<b>Remarks</b>
<b>FIS</b>	Rarotonga Flight Service	118.100 MHz 121.900 MHz (standby)	See NOTAM HR of watch ATC/FS	
<b>APP</b>	Rarotonga Tower	118.100 MHz 121.900 MHz (standby)	See NOTAM HR of watch ATC/FS	
<b>TWR</b>	Rarotonga Tower	118.100 MHz 121.900 MHz (standby)	See NOTAM HR of watch ATC/FS	
<b>AFIS</b>	Rarotonga Flight Service	118.100 MHz 121.900 MHz (standby)	See NOTAM HR of watch ATC/FS	

**NCRG AD 2.19 RADIO NAVIGATION AND LANDING AIDS**

Type of Aid, CAT (for ILS), Variation	ID	Frequency	Hours of Operation	Co-ordinates	Elevation of DME antenna	Remarks
ILS/GP		335.0	HO	S 21 12 12.42 W 159 47 53.54		RWY 26 Unusable beyond 10°L and 15°R of EXTD CL
ILS/GP		333.8	HO	S 21 12 12.40 W 159 48 45.50		RWY 08 Unusable beyond 30°R of EXTD CL
DME	RG	CH82X 113.5	H24	S 21 12 05.55 W 159 48 51.79	TBA	
NDB	RG	352kHz	H24	S 21 12 27.10 W 159 49 17.65		Rated coverage 250NM
VOR	RG	113.5	H24	S 21 12 05.55 W 159 48 51.79		Unusable R105 to R160
ILS/LOC	INO	109.9	HO	S 21 12 09.44 W 159 47 39.35		RWY 08 Unusable beyond 30°R of EXTD CL
ILS/LOC	IAV	110.3	HO	S 21 12 09.44 W 159 49 01.93		RWY 26 Unusable beyond 10°L and 15°R of EXTD CL

## NCRG AD 2.19 RADIO NAVIGATION AND LANDING AIDS (CONT)

Type of Aid, CAT (for ILS), Variation	ID	Frequency	Hours of Operation	Co-ordinates	Elevation of DME antenna	Remarks
ILS/DME	INO	36X	HO	S 21 12 12.40 W 159 48 45.50	TBA	RWY 08 Unusable beyond 30°R of EXT D CL
ILS/DME	JAV	40X	HO	S 21 12 12.42 W 159 47 53.54	TBA	RWY 26 Unusable beyond 10°L and 15°R of EXT D CL

## **NCRG AD 2.20 LOCAL TRAFFIC REGULATIONS**

### **1 AERODROME REGULATIONS**

1.1 TBA.

### **2 TAXIING TO AND FROM STANDS**

2.1 Scheduled arriving internationals will be allocated to their stands or parking position by the marshallers. Private internationals will also be allocated to their stands either by marshallers through a local handling agent or by the TWR.

2.2 Due to apron congestion and in the event of an unscheduled diversion, aircraft of medium category and higher intending to remain at the airport for more than a day are requested to carry a towbar to assist positioning on the apron unless crew are available to relocate aircraft at short notice.

### **3 PARKING AREA FOR GENERAL AVIATION**

3.1 There are two stands able to accommodate up to wide-bodied B747 and smaller aircraft under their own power provided they do not overrun the stop blocks. There are an additional two new parking pads available to accommodate domestic aircraft only.

### **4 PARKING AREA FOR HELICOPTERS**

4.1 No specific area is available. Arriving aircraft will be allocated a parking position by the TWR.

### **5 APRON — TAXIING**

5.1 Taxi instruction will be given by ATC or for non-scheduled flights without marshalling personnel will be directed to their parking position.

### **6 TAXIING — LIMITATIONS**

6.1 Nil.

### **7 REMOVAL OF DISABLED AIRCRAFT FROM RUNWAYS**

7.1 For aircraft up to 21000kg — improvised equipment available locally.

7.2 For aircraft 21000–150,000kg — salvage kit ex Auckland.

7.3 For aircraft above 150,000kg — IATA kit ex Sydney, Honolulu or Los Angeles.

## **NCRG AD 2.21 NOISE ABATEMENT PROCEDURES**

There are no noise abatement procedures for Rarotonga.

## **NCRG AD 2.22 FLIGHT PROCEDURES**

### **1 POSITION AND ALTITUDE REPORTING — LOCAL VFR FLIGHTS**

1.1 Local VFR scenic flights are to follow the normal traffic circuit pattern and advise TWR/FS of any manoeuvres/intentions outside of the norm.

### **2 POSITION REPORTING ON DEPARTURE**

2.1 Pilots are required to make a departure report as soon as practicable after take-off. Departure reports must contain the following info in the order listed:

- (a) Identification; radio callsign
- (b) The estimated set heading time in minutes past the hour
- (c) The altitude to the nearest 100ft, followed by the phrase "CLIMBING TO" followed by the cleared altitude or flight level of the initial portion of the flight
- (d) Next position and time over in minutes past the hour

### **3 AERODROME TRAFFIC CIRCUIT RULES**

3.1 Unless otherwise authorised by ATC, the circuit direction for:

- (a) RWY 08 is left-hand; and
- (b) RWY 26 is right-hand

## **NCRG AD 2.23 ADDITIONAL INFORMATION**

### **1 RNAV (RNP)**

1.1 Specific approval by the Director of CAA, Cook Islands is required to fly the RNAV (RNP) approach.

## NCRG AD 2.24 CHARTS RELATED TO AERODROME

### (a) Standard Instrument Arrival (STAR) Charts

RAROTONGA STAR RWY 08 .....	NCRG AD 2-33.1
RAROTONGA STAR RWY 26 .....	NCRG AD 2-33.2

### (b) Instrument Approach Charts

RAROTONGA ILS/DME or LOC/DME RWY 08 .....	NCRG AD 2-41.1
RAROTONGA ILS/DME or LOC/DME RWY 26 .....	NCRG AD 2-41.2
RAROTONGA VOR/DME or VOR RWY 08 .....	NCRG AD 2-43.1
RAROTONGA VOR/DME A .....	NCRG AD 2-43.2
RAROTONGA VOR/DME B .....	NCRG AD 2-43.3
RAROTONGA NDB/DME or NDB RWY 08 .....	NCRG AD 2-44.1
RAROTONGA RNAV (GNSS) Z RWY 08 .....	NCRG AD 2-45.1
RAROTONGA RNAV (GNSS) Y RWY 08 .....	NCRG AD 2-45.2
RAROTONGA RNAV (GNSS) X RWY 08 .....	NCRG AD 2-45.3
RAROTONGA RNAV (RNP) W RWY 08 .....	NCRG AD 2-45.4
RAROTONGA RNAV (GNSS) Z RWY 26 .....	NCRG AD 2-45.5
RAROTONGA RNAV (RNP) Y RWY 26 .....	NCRG AD 2-45.6

### (c) Aerodrome Chart

RAROTONGA .....	NCRG AD 2-51.1
-----------------	----------------

### (d) Ground Movements Chart

RAROTONGA .....	NCRG AD 2-53.1
-----------------	----------------

### (e) Departure Chart

RAROTONGA Departures .....	NCRG AD 2-62.1
----------------------------	----------------



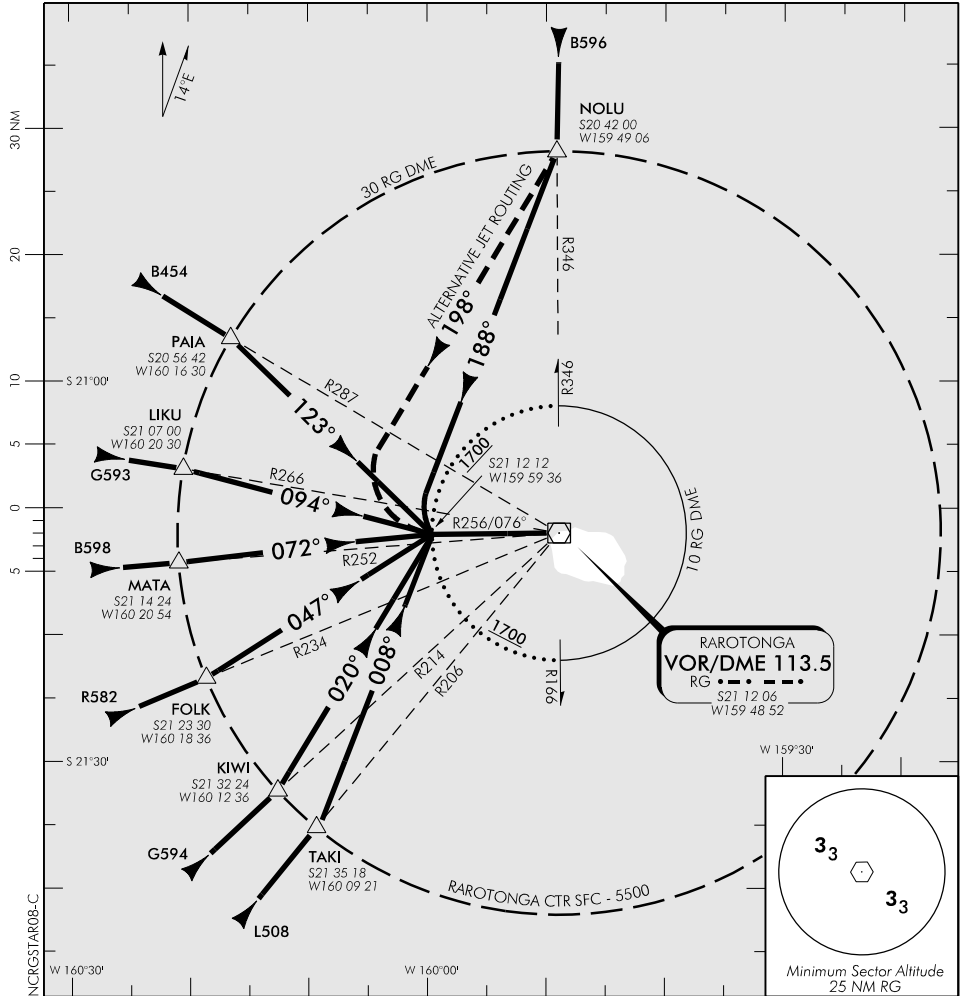
ELEV 19

NCRG

# RAROTONGA

## STAR RWY 08

APPROACH AND AERODROME CONTROL RAROTONGA TOWER: 118.1 121.9



### ALL ARRIVALS

- Descend to MNM 1700 ft to join final approach ILS, LOC/DME, or VOR/DME RWY 08 at not less than 10 NM DME.
- Clearance for a STAR does not constitute clearance for instrument approach.

**Effective: 13 SEP 18**

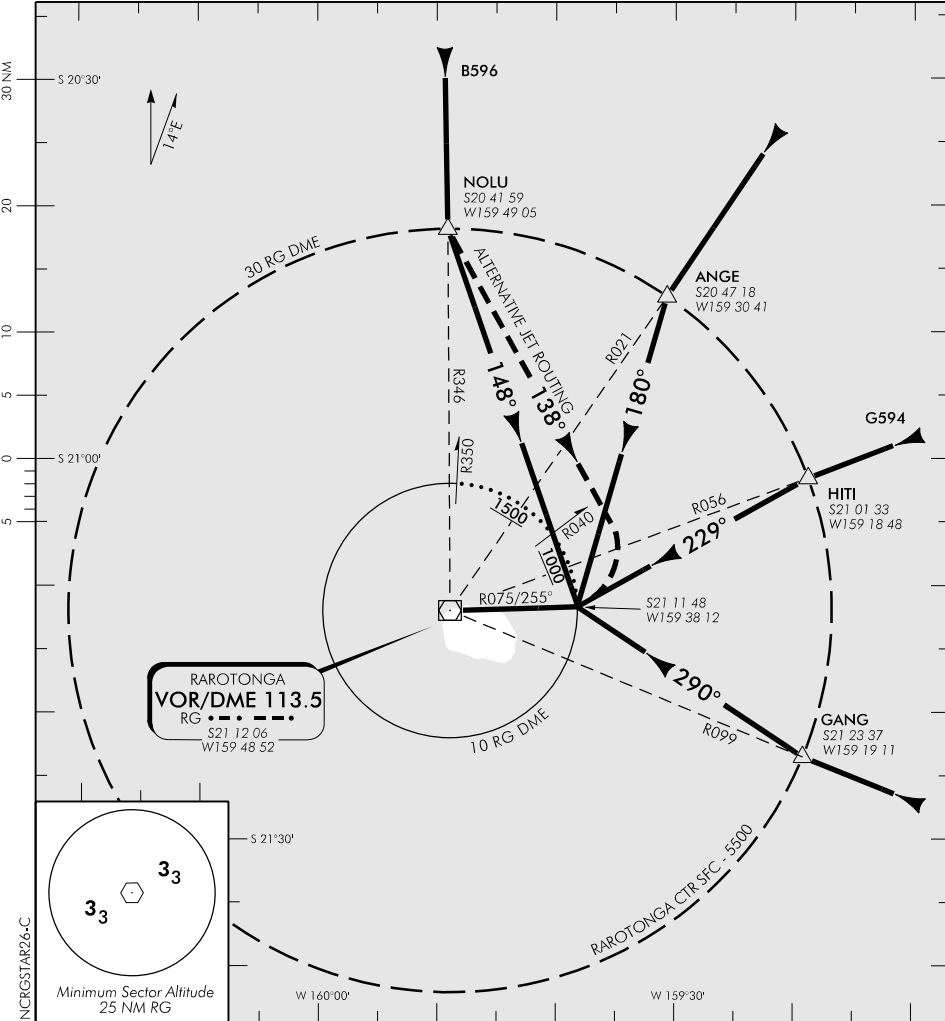
ELEV 19

NCRG

# RAROTONGA

## STAR RWY 26

APPROACH AND AERODROME CONTROL RAROTONGA TOWER: 118.1 121.9



Changes from 2 APR 15: AD ELEV.

### ALL ARRIVALS

- Descend to MNM 2000 ft to join final approach ILS, LOC/DME RWY 26 or MNM 1000 ft to join final approach VOR/DME A at not less than 10 NM DME.
- Clearance for a STAR does not constitute clearance for instrument approach.

**Effective: 13 SEP 18**

ELEV 19

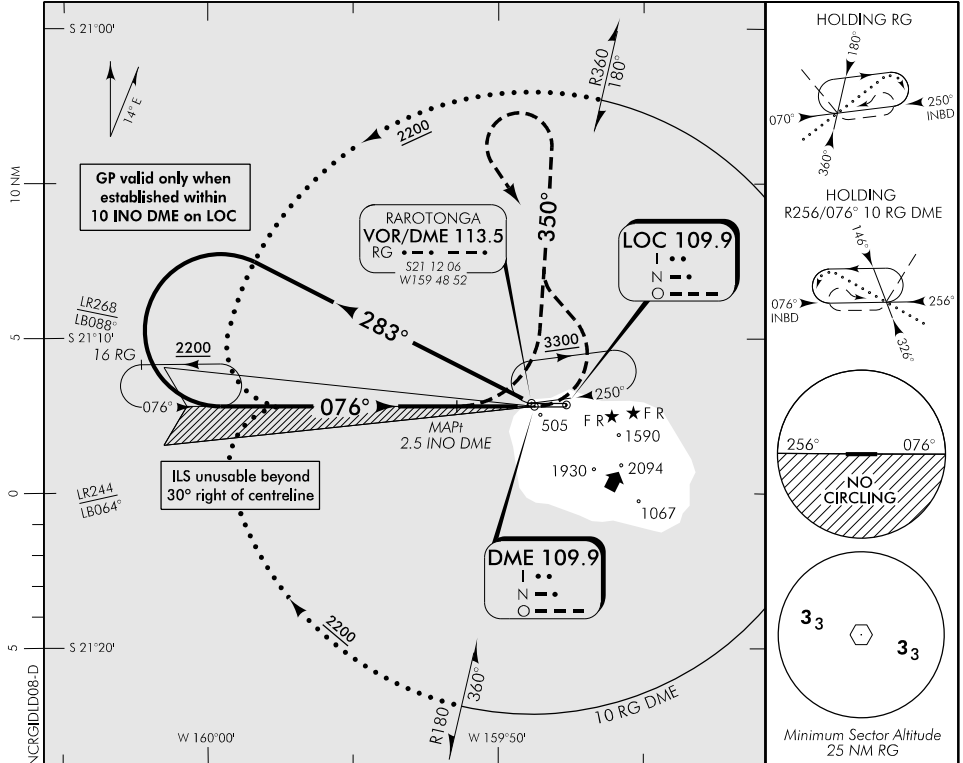
CAT A,B,C,D

# RAROTONGA

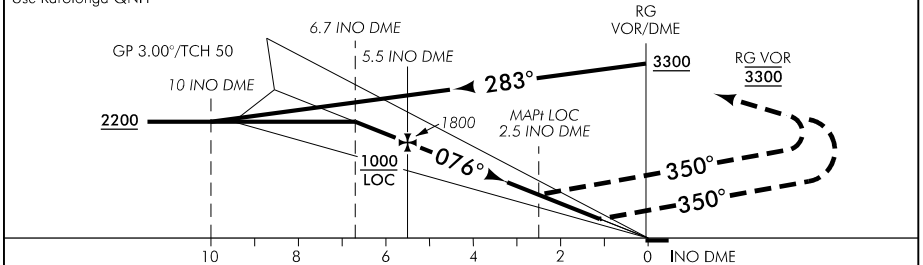
RWY 08 THR ELEV 19

**ILS/DME or LOC/DME RWY 08**

APPROACH AND AERODROME CONTROL RAROTONGA TOWER: 118.1 121.9



Use Rarotonga QNH



**MISSED APCH:** MAX IAS 185 kt. Turn LEFT, intercept R350 RG VOR, return to RG holding 3300, or as instructed by ATC.

INO DME DIST	10	9	8	7	6	5	4	3	2.7	1.1
Advisory Altitude 3°	3290	2960	2620	2290	1960	1630	1310	980	MDA	DA
Category	A			B			C		D	
ILS/DME	380(361) – 2000						400(381) – 2000			
LOC/DME	820(801) – 5						960(941) – 5			
Circling Restricted *	860(841) – 5						960(941) – 5			

\* Circling NA South of RWY 08/26

Changes from 17 SEP 15: Procedure reviewed, minima, AD ELEV, advisory altitude table, missed approach.

**Effective: 8 NOV 18**

ELEV 19

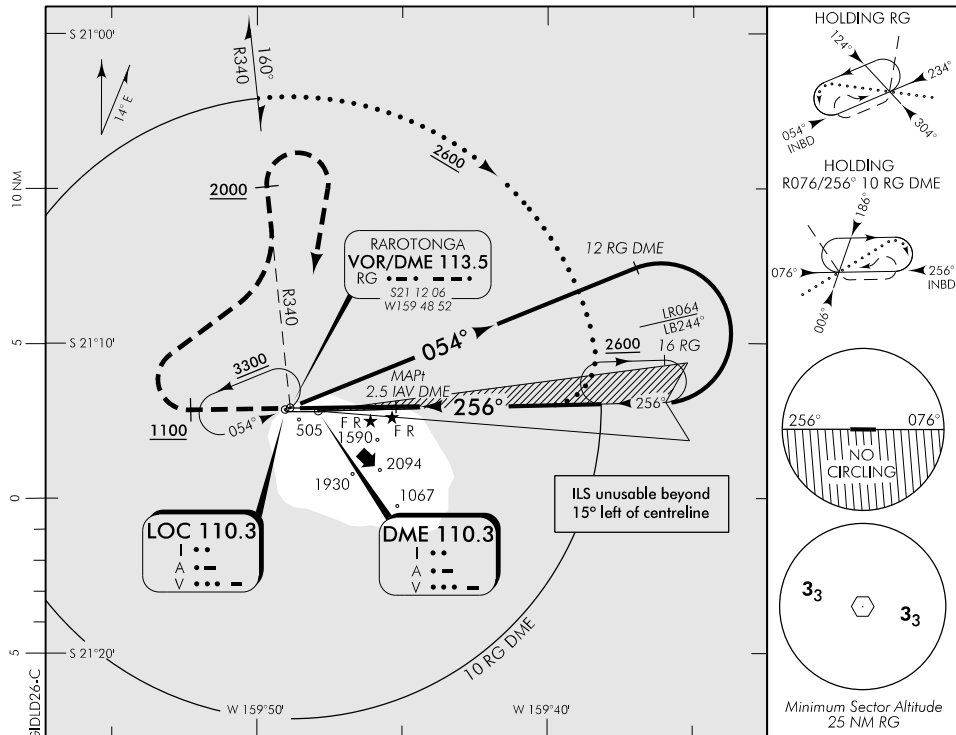
CAT A,B,C,D

# RAROTONGA

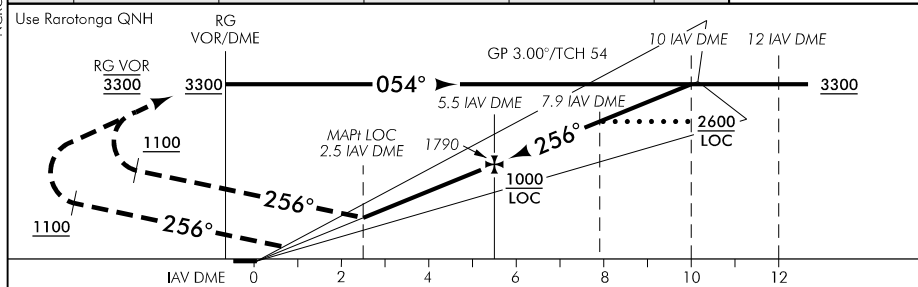
RWY 26 THR ELEV 14

## ILS/DME or LOC/DME RWY 26

APPROACH AND AERODROME CONTROL RAROTONGA TOWER: 118.1 121.9



Changes from 2 APR 15: Procedure reviewed, minima, AD and THR ELEV, advisory altitude table, missed approach.



**MISSED APCH:** MAX IAS 185 kt. Track 256° to **1100**, turn RIGHT intercept R340 RG VOR to **2000**, turn RIGHT direct to RG VOR **3300**, or as instructed by ATC.

IAV DME DIST	0.8	2.6	3	4	5	6	7	8	9	10	11	12
Advisory Altitude 3"	DA	MDA	980	1300	1630	1960	2290	2620	2950	3290	3630	3960
Category	A		B			C			D			
ILS/DME	700(686) - 3700						730(716) - 3900					
ILS/DME *	280(266) - 1800											
LOC/DME	980(961) - 5											
LOC/DME *	830(811) - 4800											
Circling Restricted #	980(961) - 5											
* Missed approach minimum climb gradient 4.0% (250 ft/NM)						# Circling NA South of RWY 08/26						

**Effective: 8 NOV 18**

ELEV 19

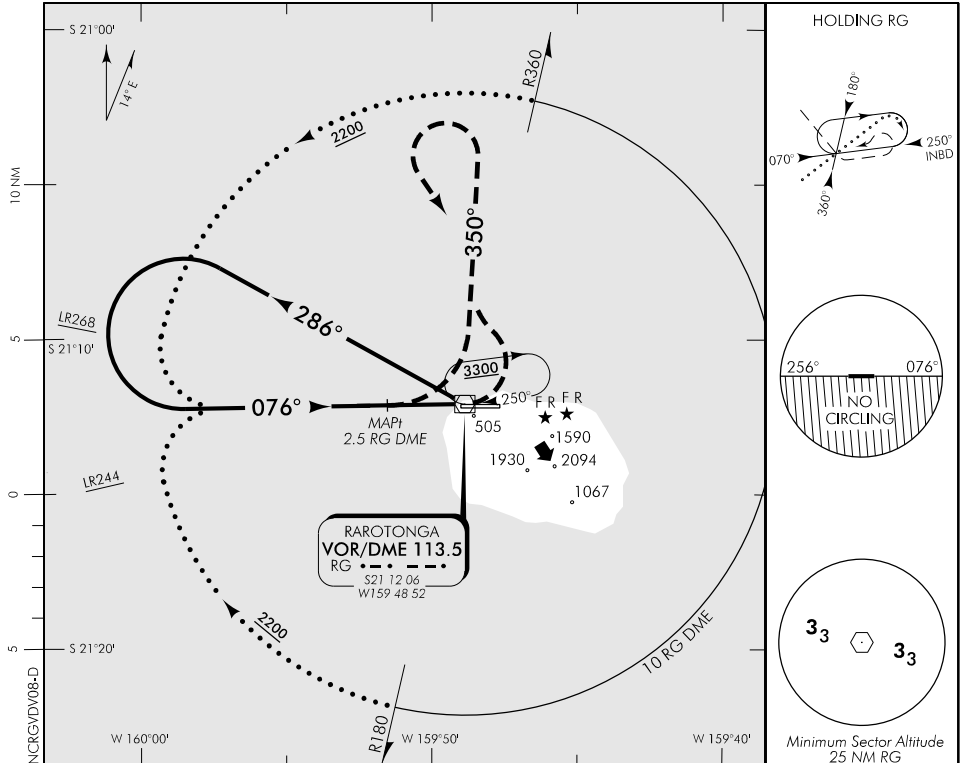
CAT A,B,C,D

**RAROTONGA**

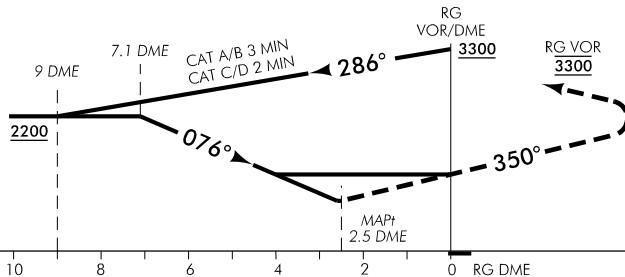
RWY 08 THR ELEV 19

**VOR/DME or VOR RWY 08**

APPROACH AND AERODROME CONTROL RAROTONGA TOWER: 118.1 121.9



Use Rarotonga QNH



**MISSED APCH:** CAT D MAX IAS 185 kt. CAT C MAX IAS 160 kt. Turn LEFT, intercept R350 RG VOR, return to RG holding 3300 or as instructed by ATC.

RG DME DIST	9	8	7	6	5	4	3	2.6	MAPt 2.5
Advisory Altitude 5%	2750	2450	2150	1850	1550	1250	950	MDA	MDA
Category	A		B			C		D	
VOR/DME	820(801) – 5							890(871) – 5	
VOR	1260(1241) – 5								
Circling Restricted *	1260(1241) – 5								

\* Circling NA South of RWY 08/26

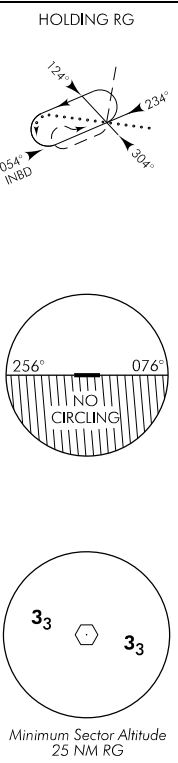
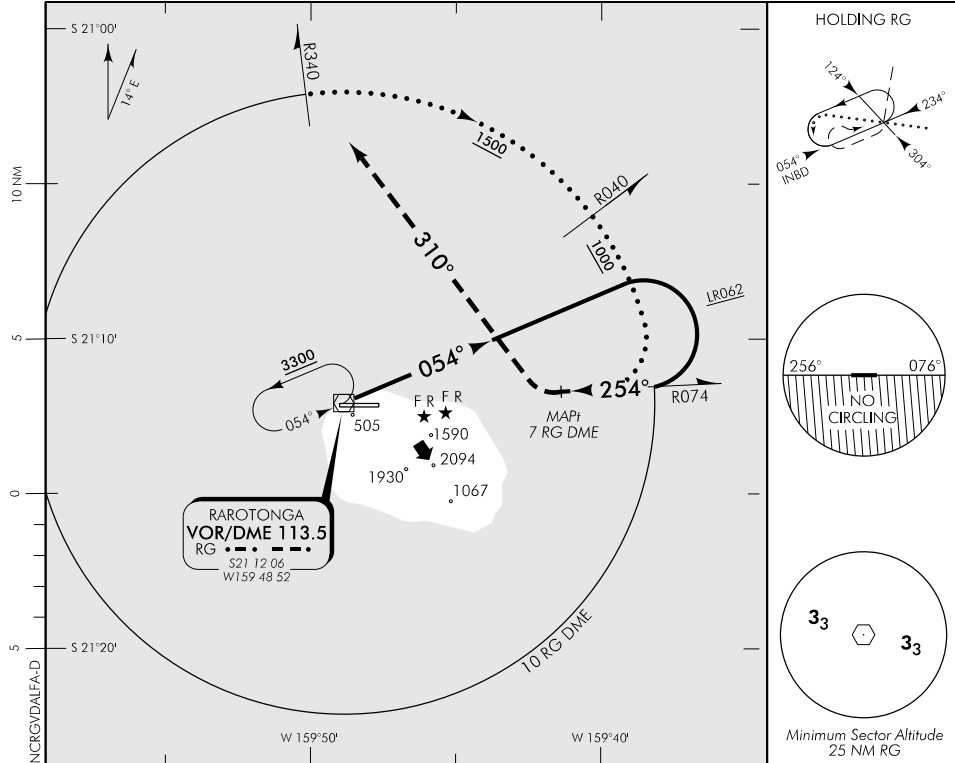
**Effective: 8 NOV 18**

© Government of Cook Islands

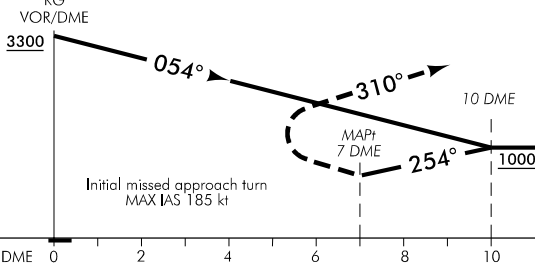
**RAROTONGA**  
**VOR/DME or VOR RWY 08**

Changes from 13 SEP 18: Missed APCH text, ALTIN table removed, DME reference in advisory ALT table.

APPROACH AND AERODROME CONTROL RAROTONGA TOWER: 118.1 121.9



Use Rarotonga QNH



**MISSED APCH:** Turn RIGHT, track 310°. Return to RG holding **3300** or as instructed by ATC

Category	A	B	C	D
Circling *	D 780(761) – 5.5		880(861) – 5.5	
	N 780(761) – 10		880(861) – 10	

\* Circling NA South of Runway  
This procedure is not suitable for night alternate planning

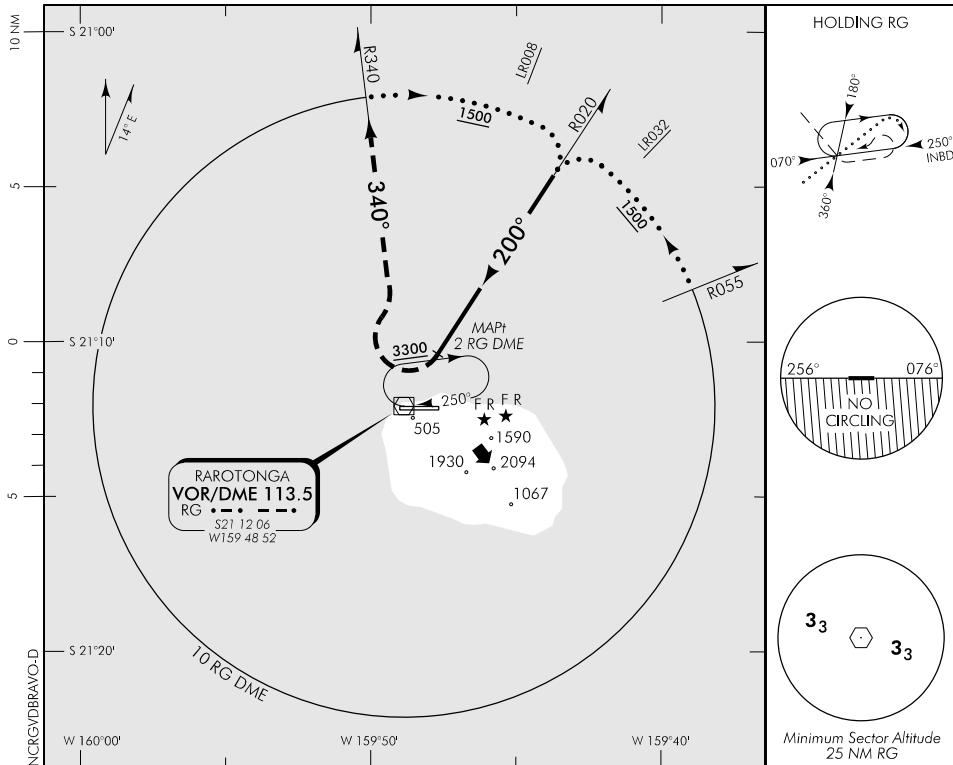
Changes from 13-SEP-18: -ALTN table removed, missed approach text, RG minimum hold.

ELEV 19

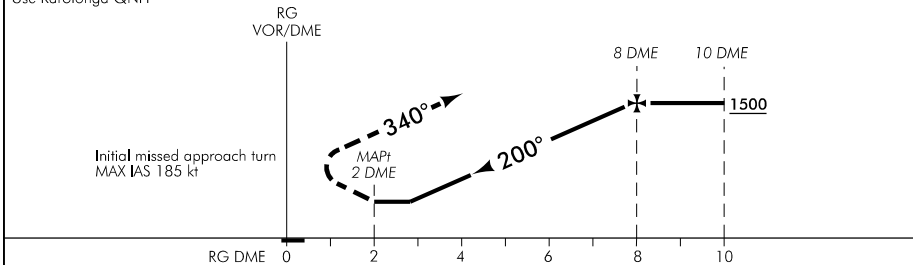
CAT A,B

**RAROTONGA**  
**VOR/DME B**

APPROACH AND AERODROME CONTROL RAROTONGA TOWER: 118.1 121.9



Use Rarotonga QNH



**MISSED APCH:** Turn RIGHT, intercept R340 RG VOR. Return to enter RG holding 3300 or as instructed by ATC

RG DME DIST	MAPI 2	3	4	5	6	7	8
Advisory Altitude	160ft / NM 5%	MDA	700	860	1020	1180	1340
			1000	1300	1600		1500
Category	A		B		C		D
Circling *	780 (761) – 5.5		780 (761) – 10		NA		NA

\* Circling NA South of Runway  
This procedure is not suitable for night alternate planning

Changes from 13 SEP 18: ALTN table removed, missed approach text, RG minimum hold.

**Effective: 8 NOV 18**

**Intentionally  
Blank**



ELEV 19

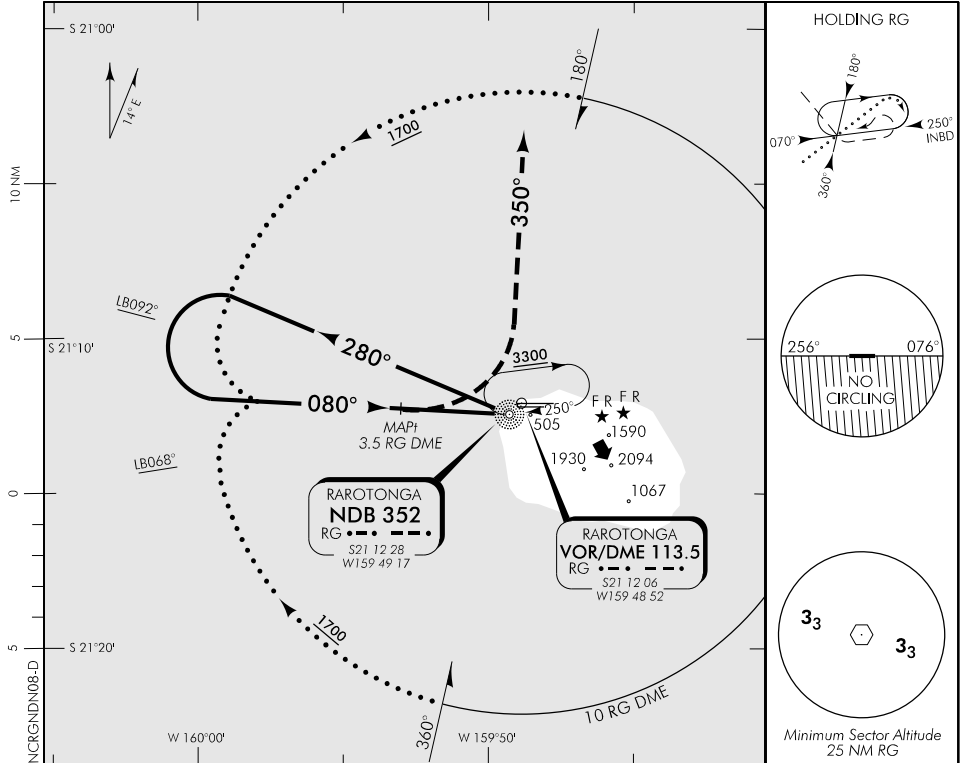
CAT A,B,C,D

# RAROTONGA

RWY 08 THR ELEV 19

**NDB/DME or NDB RWY 08**

APPROACH AND AERODROME CONTROL RAROTONGA TOWER: 118.1 121.9



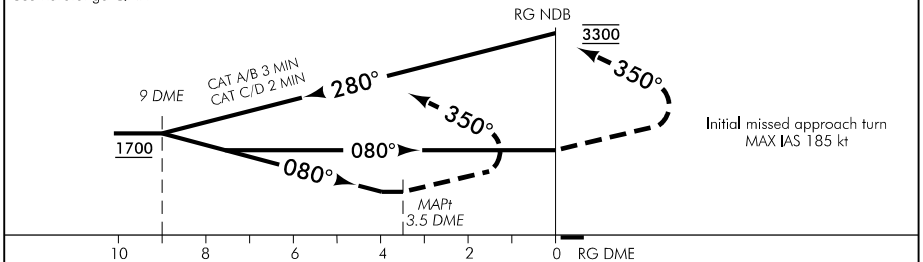
**HOLDING RG**

**NO CIRCLING**

**3<sub>3</sub>**

Minimum Sector Altitude  
25 NM RG

Use Rarotonga QNH



**MISSED APCH:** Turn LEFT, intercept 350° RG NDB. Return to RG holding: 3300 or as instructed by ATC

RG DME DIST	9	8	7	6	5	4	MAP: 3.5
Advisory Altitude 220ft / NM	1700	1480	1260	1040	820	600	MDA
5%		1800	1500	1200	900	600	
Category	A		B		C		D
STA NDB/DME	D 500(481) – 4000		N 500(481) – 6.5		D 720(701) – 4000		N 720(701) – 6.5
Circling * NDB/DME	550(531) – 6.5		780(761) – 6.5		880(861) – 6.5		
Circling * NDB	1700(1681) – 4000				1700(1681) – 5		

\* Circling NA South of Runway

**Effective: 8 NOV 18**

Changes from 13 SEP 18: ALTN table removed, missed approach text, RG minimum hold.

**Intentionally  
Blank**

ELEV 19

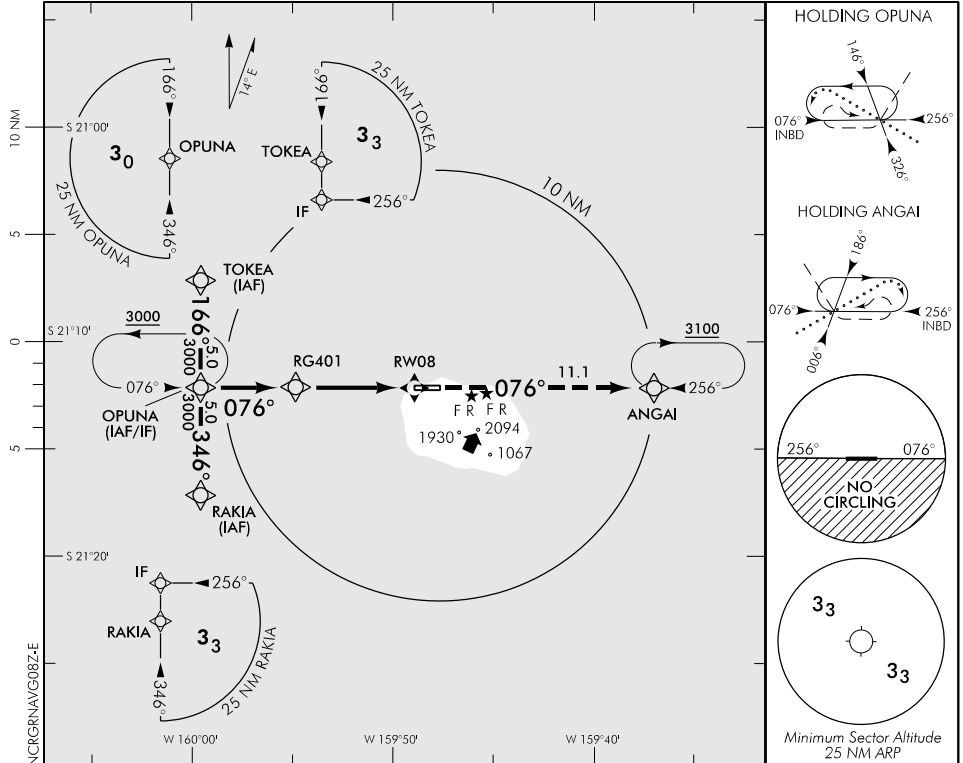
CAT A,B,C,D

# RAROTONGA

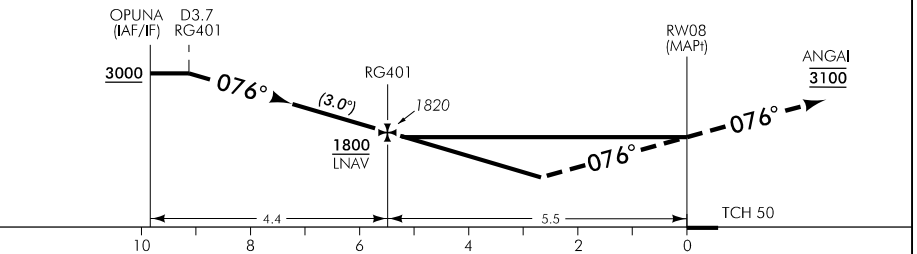
RWY 08 THR ELEV 19

**RNAV (GNSS) Z RWY 08**

APPROACH AND AERODROME CONTROL RAROTONGA TOWER: 118.1 121.9



Use Rarotonga QNH



**MISSED APCH:** Track 076° to ANGAI 3100

DISTANCE to WPT	OPUNA	4	3	2	1	RG401	5.2	2.7	RWY08
Advisory Altitude 3°	3230	3100	2780	2460	2140	1820	MDA	DA	MDA
Category	A		B			C		D	
LNAV/VNAV *	1170(1151) – 5					1220(1201) – 5			
LNAV/VNAV **	920(901) – 5					980(961) – 5			
LNAV	1730(1711) – 5								
Circling Restricted #	1730(1711) – 5								

\* Valid to MNM temperature 15°C. Use of remote QNH NA

\*\* Missed approach climb gradient MNM 4.2% (260 ft/NM) required. Use of remote QNH NA.

# Circling NA south of RWY 08/26

**Effective: 19 JUL 18**

Changes from 23 JUL 15: Chart title, minima, advisory altitude table, ANGAI HP MSA.

ELEV 19

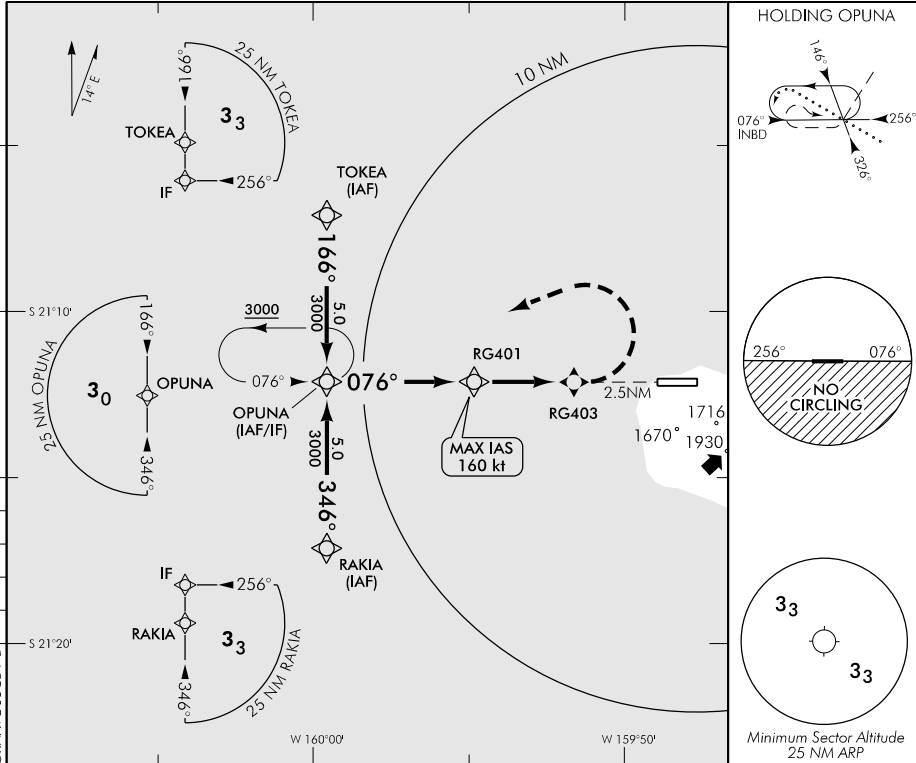
CAT C,D

**RAROTONGA**

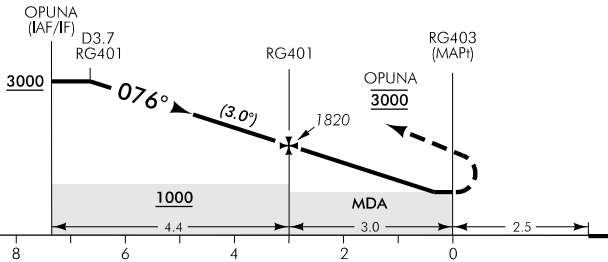
RWY 08 THR ELEV 19

**RNAV (GNSS) Y RWY 08**

APPROACH AND AERODROME CONTROL RAROTONGA TOWER: 118.1 121.9



Use Rarotonga QNH



MISSED APCH: MAX IAS 185 kt. Turn LEFT, direct to OPUNA 3000

DISTANCE to WPT	OPUNA	4	3	2	1	RG401	2	1	0.3	RG403
Advisory Altitude 3°	3230	3090	2780	2460	2140	1820	1500	1180	MDA	MDA
Category	A		B			C		D		
RNAV	NA					990(971) – 5				
RNAV *	NA					870(851) – 5				
Circling Restricted #	NA					990(971) – 5				

\* Missed approach climb gradient MNM 3.6% (220 ft/NM) required  
# Circling NA south of RWY 08/26

Changes from 2 APR 15: Minima, advisory altitude table, AD ELEV.

**Effective: 19 JUL 18**

ELEV 19

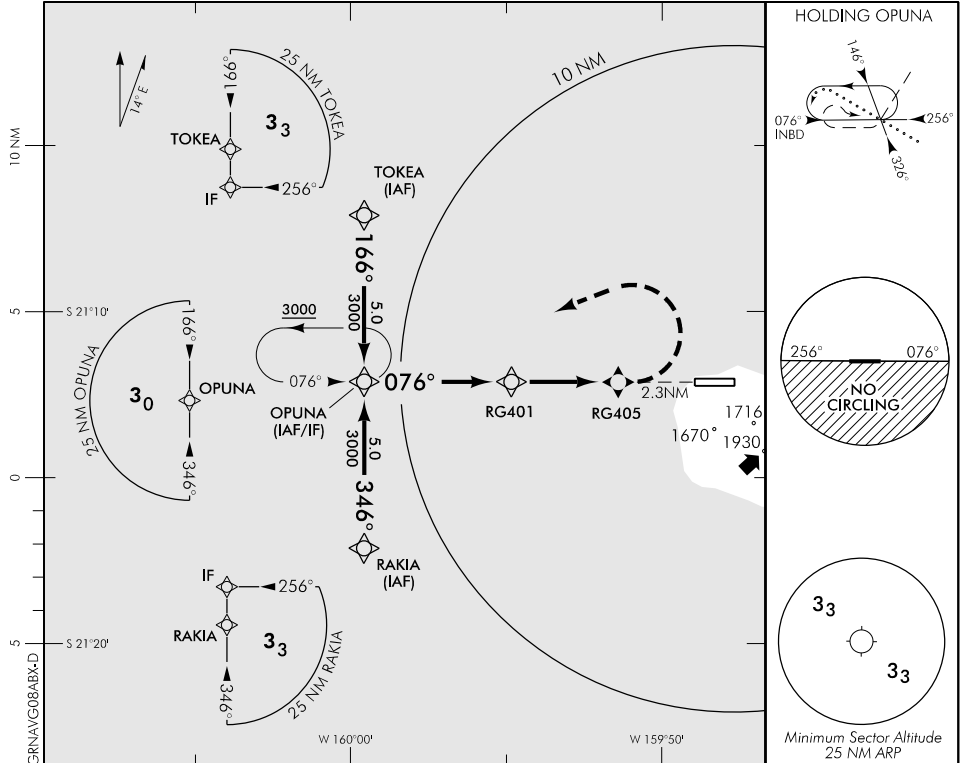
CAT A,B

# RAROTONGA

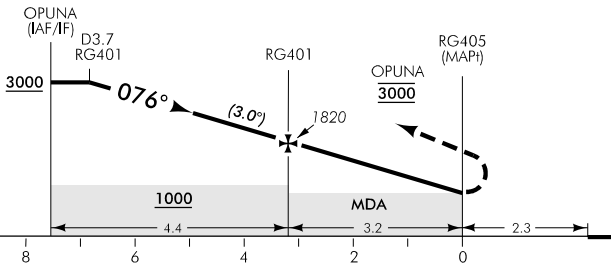
RWY 08 THR ELEV 19

RNAV (GNSS) X RWY 08

APPROACH AND AERODROME CONTROL RAROTONGA TOWER: 118.1 121.9



Use Rarotonga QNH



**MISSED APCH: MAX IAS in turn 130 kt. Turn LEFT, direct to OPUNA 3000**

DISTANCE to WPT	OPUNA	4	3	2	1	RG401	3	2	1	RG405
Advisory Altitude 3°	3230	3090	2780	2460	2140	1820	1760	1440	1120	MDA
Category	A		B			C		D		
LNAV	800(781) – 5					NA				
Circling Restricted #	800(781) – 5		860(841) – 5							
# Circling NA south of RWY 08/26										

Effective: 19 JUL 18

ELEV 19

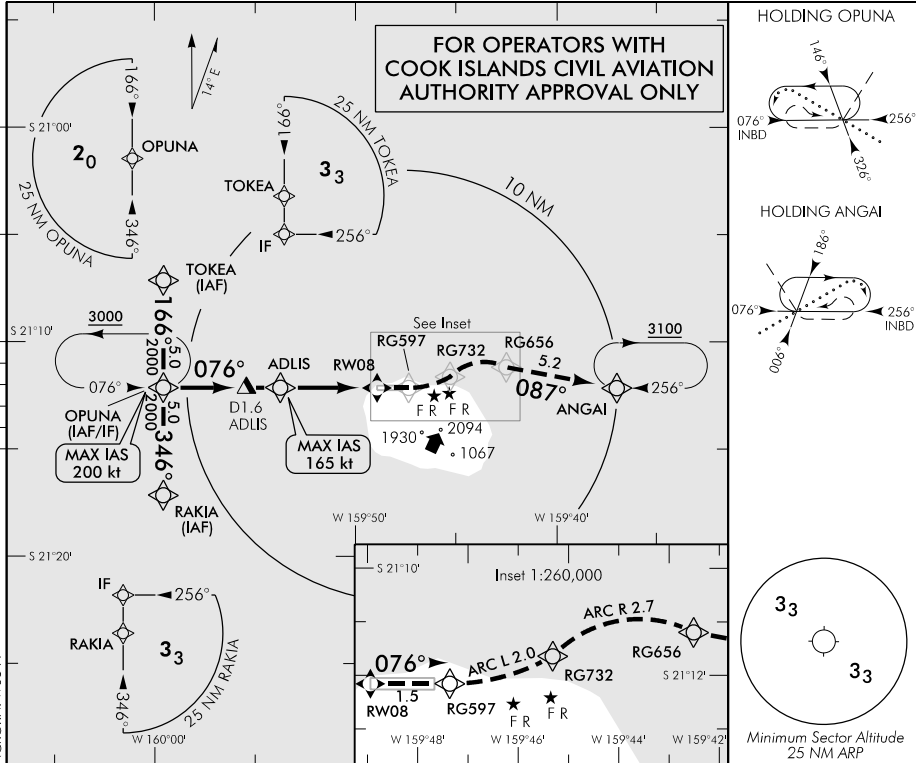
CAT C,D

# RAROTONGA

RWY 08 THR ELEV 19

## RNAV (RNP) W RWY 08

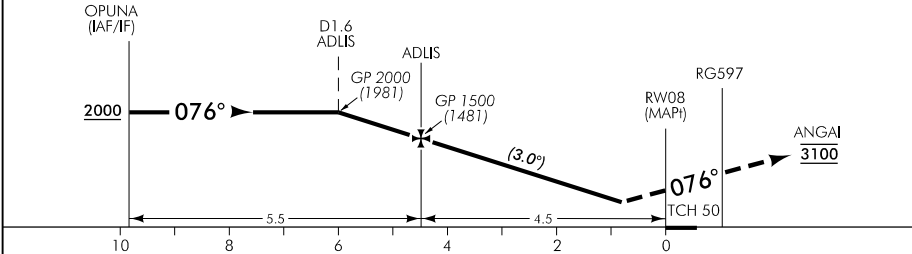
APPROACH AND AERODROME CONTROL RAROTONGA TOWER: 118.1 121.9



NCRGRNPW08-A

New chart.

Use Rarotonga QNH only



**MISSED APCH:** MAX IAS 185 kt. Track via the RNAV (RNP) Missed Approach to ANGAI 3100

Category	A	B	C	D
RNP 0.11	NA		440(421) – 2400	
RNP 0.2			550(531) – 3200	
RNP 0.3			850(831) – 4800	

1. Procedure NA when AD temperature is below +10°C or above 47°C.
2. RF required.
3. Maintain approach RNP value until RG732, then RNP 1.0.

**Effective: 19 JUL 18**

ELEV 19

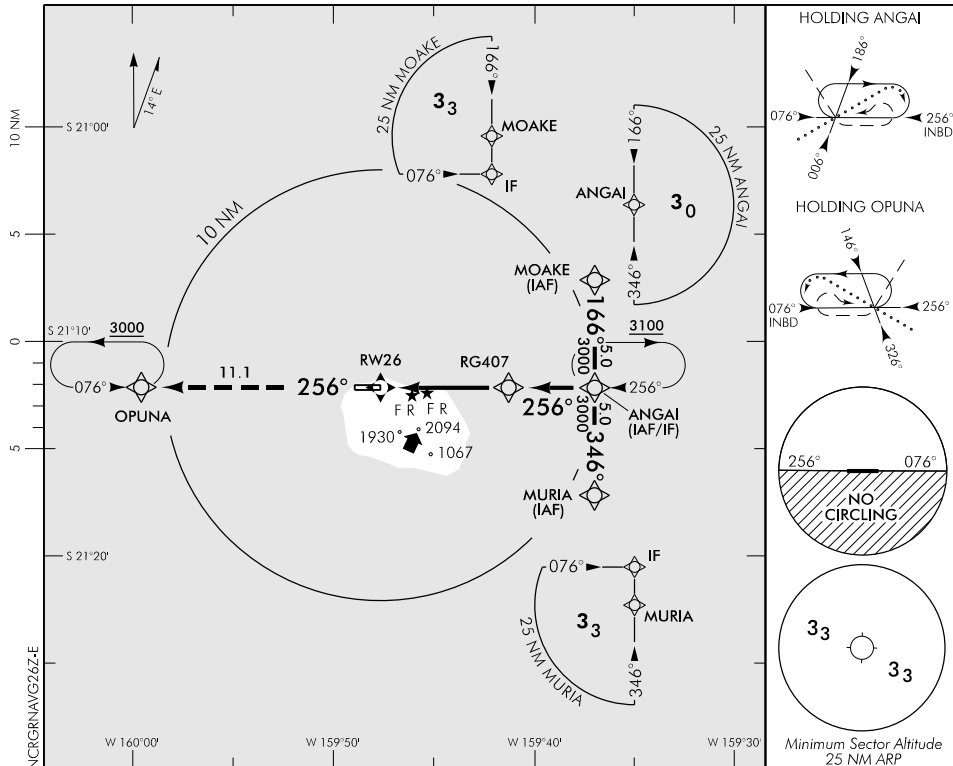
CAT A,B,C,D

# RAROTONGA

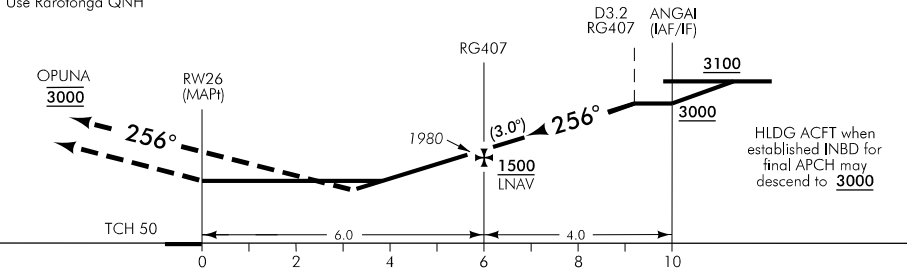
RWY 26 THR ELEV 14

RNAV (GNSS) Z RWY 26

APPROACH AND AERODROME CONTROL RAROTONGA TOWER: 118.1 121.9



Use Rarotonga QNH



MISSED APCH: Track 256° to OPUNA 3000

DISTANCE to WPT	RWY26	3.1	3.9	4	5	RG407	1	2	3	ANGAI
Advisory Altitude 3°	MDA	DA	MDA	1340	1660	1980	2290	2610	2930	3250
Category	A			B			C		D	
LNAV/VNAV *	1050(1036) – 5					1110(1096) – 5				
LNAV						1310(1291) – 5				
Circling Restricted #						1310(1291) – 5				

\* Valid to MNM temperature 15°C. Use of remote QNH NA

# Circling NA south of RWY 08/26

Effective: 19 JUL 18

Changes from 23 JUL 15: Chart title, minima, advisory altitude table, ANGAI HP MSA.

ELEV 19

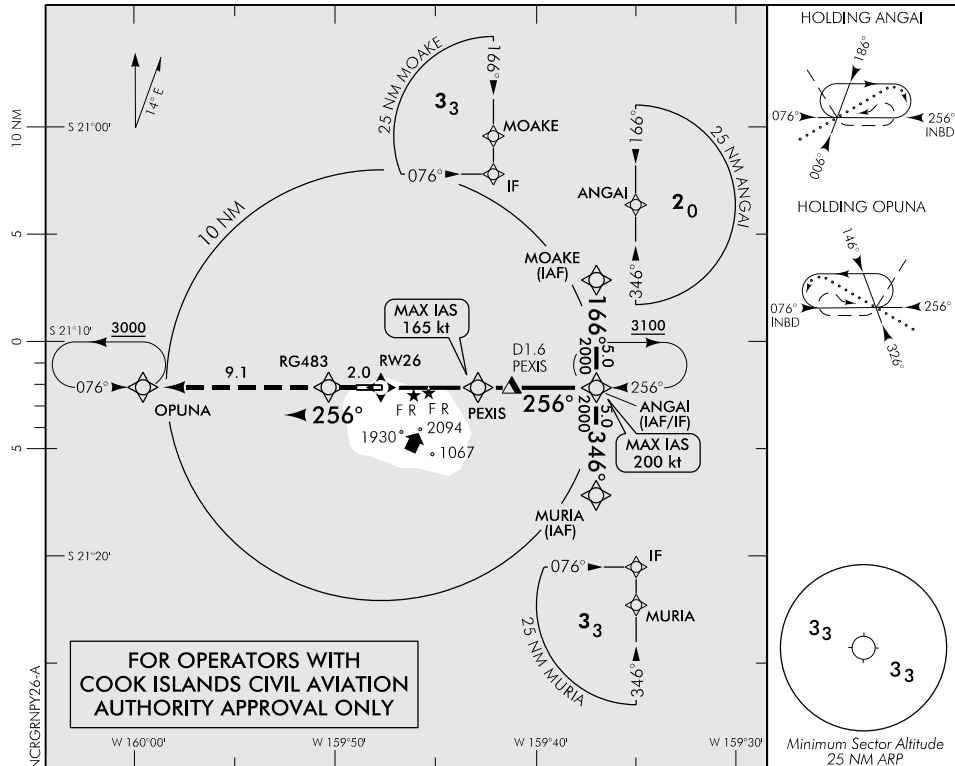
CAT C,D

# RAROTONGA

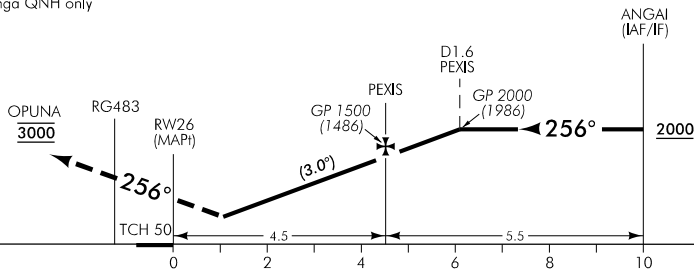
RWY 26 THR ELEV 14

RNAV (RNP) Y RWY 26

APPROACH AND AERODROME CONTROL RAROTONGA TOWER: 118.1 121.9



Use Rarotonga QNH only



New chart.

MISSED APCH: MAX IAS 185 kt. Track 256° via RG483 to OPUNA 3000

Category	A	B	C	D
RNP 0.11	NA		460(446) – 2400	
RNP 0.2			720(706) – 4000	
RNP 0.3			850(836) – 4800	

1. Procedure NA when AD temperature is below +10°C or above 47°C.
2. Maintain approach RNP value until RG483, then RNP 1.0.

**Effective: 19 JUL 18**

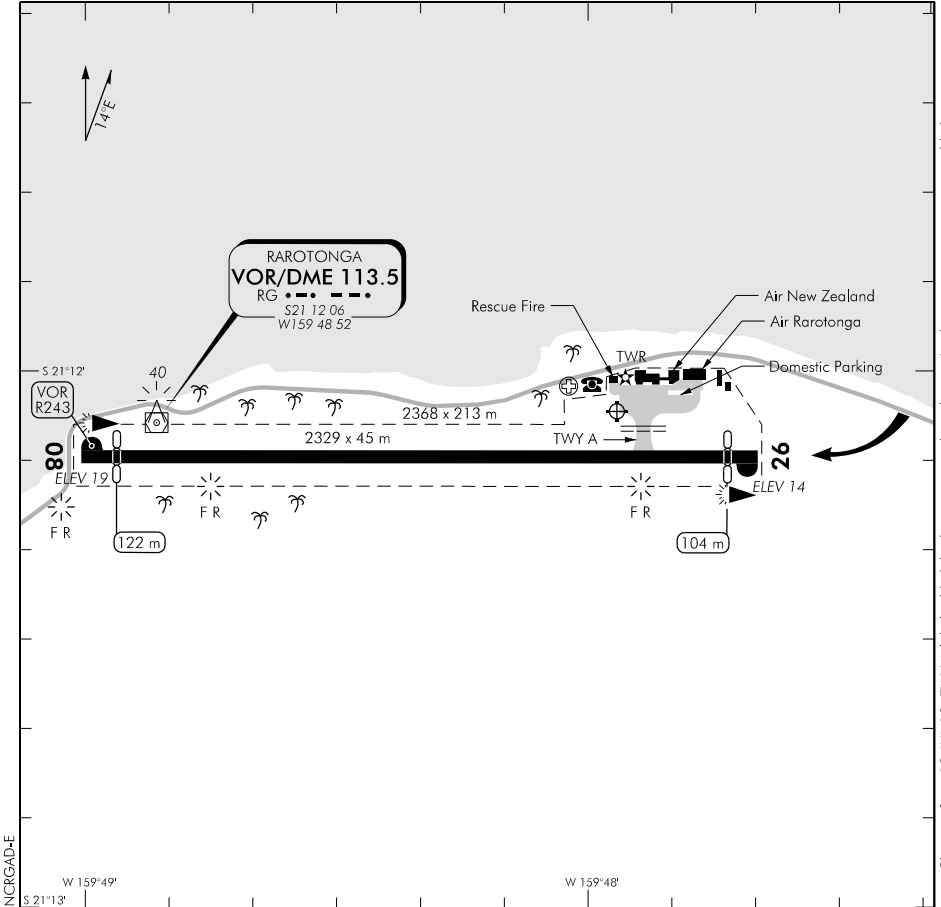


ELEV 19

NCRG

TOWER: 118.1 121.9

# RAROTONGA AERODROME



NCRGAD-E

1. Circuit: RWY 08 - Left hand  
RWY 26 - Right hand
2. Unlit mast approx 513 ft AMSL, positioned 1260 m SSW of RWY 08 threshold.
3. **CAUTION:** Seasonal migratory small seabirds congregate on the taxiway and runway.
4. Two stands for international parking. Stand 1 in front of Tower building. Stand 2 in front of Terminal building. Domestic parking located east next to Stand 2.
5. Ships cranes or yachts with tall masts berthed in harbour approximately 1 km east of runway. Yachts will be moved and cranes lowered as per letter of agreement with Ports Authority (harbourmaster).

CIVIL IFR TAKE-OFF MINIMA			VFR MINIMA		
CEILING (ft) and VISIBILITY (m or km)			CEILING (ft) and VISIBILITY (m or km)		
RWY	DAY	NIGHT		DAY	NIGHT
08	300 – 1500	300 – 1500	AIR TRANSPORT	1500 – 8	3000 – 16
26	300 – 1500	300 – 1500	ALL OTHER	1500 – 8	3000 – 16
+ Night training subject to ATC approval			NIGHT TRAINING	NA	1500 – 8+

**Effective: 13 SEP 18**

S 21 12 05 W 159 47 57

© Government of Cook Islands

**RAROTONGA  
AERODROME**

# RAROTONGA GROUND MOVEMENTS

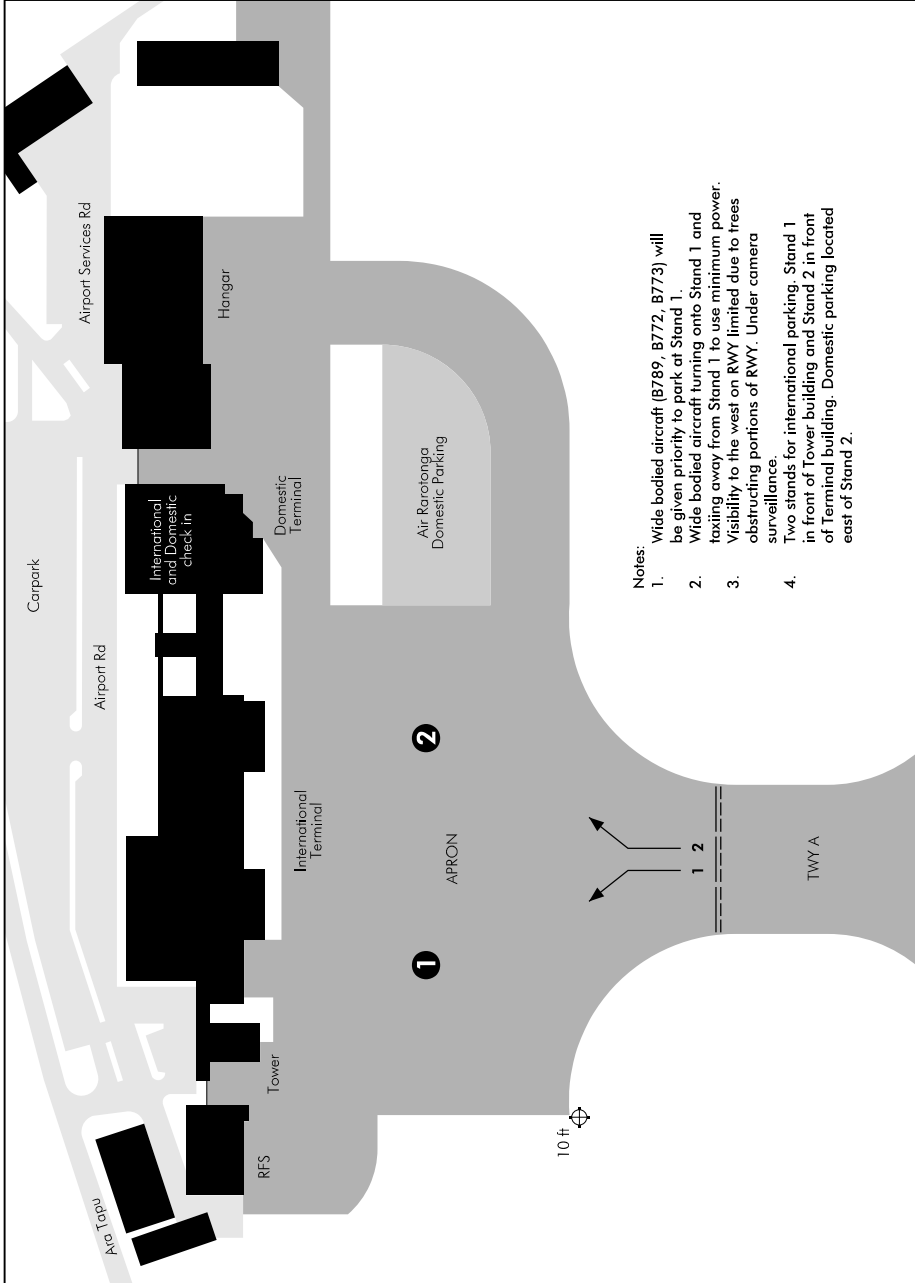
ELEV 19

NCRG

TOWER: 118.1 121.9

GROUND: 121.9

NCRGGM-A



Notes:

1. Wide bodied aircraft (B789, B772, B773) will be given priority to park at Stand 1.
2. Wide bodied aircraft turning onto Stand 1 and taxiing away from Stand 1 to use minimum power. Visibility to the west on RWY limited due to trees obstructing portions of RWY. Under camera surveillance.
3. Two stands for international parking. Stand 1 in front of tower building and Stand 2 in front of Terminal building. Domestic parking located east of Stand 2.

ELEV 19

NCRG

TOWER: 118.1 121.9

# RAROTONGA

## DEPARTURES

### ***RWY 08 DEPARTURE***

- Maintain RWY CL to 1500ft
- Mandatory Left Turn
- Intercept cleared route

(or as instructed by ATC)

or

### ***RWY 26 DEPARTURE***

- Maintain RWY CL to 1500ft
- Left or right turn
- Intercept cleared route

(or as instructed by ATC)

**Intentionally  
Blank**